

A

	PAGE
A & B Epoxy Paste	110
A & B Epoxy Putty	110
Abrasive Pads	76
Abrasive Sandcloth	76
Access Cover	178
Access Panels	178
Acetylene Gas Equipment	144, 145
Acid Brushes	33
Adapters, Faucet	115-119
Add A Hanger	54
Adjustable Hose Clamps	177
Adjustable Internal Wrench	16
Adjustable Socket Wrench	106
Adjustable Wrenches	5, 6
Aerators, Faucet	115-119
Air Admittance Valves	111
Air Gap	191
Air Nozzles	95
Air Valve Key	181
Air Valves	84
"Allen" Wrench Kits	151-153
"Allen" Wrench Sets	151-153
Altitude Gauges	60
Aluminum Tubing	188
Anchor Kits	46
Anchors	46-48
Arbors	72
Arctec Freeze Kit	187
Auto Tube Cutter	86
Automatic Trap Vents	111
Awls	124

B

Baby Hack Saw Blades	26
Baby Hack Saw Frames	26
Baby J-hooks	53
Bags, Tote	79
Ballcock Waterfill Valve Wrench	17
Ball End Hex Key Sets	153
Ball Valves	81
Banding	174
Bargrates	193
Bars, Grab	193
Bars, Ripping	20
Basin Plug Snakes	157
Basin Scoop	138
Basin Supply Connectors	176
Basin Washers	131
Basin Wrenches	14
Basket Strainers	190
Basset Brackets	168-174
Batteries	81
Bay Flange	106
Beam Clamps	169

B Continued

	PAGE
Bell Hangers	56, 70
Bending Springs	91
Bi-Metal Blades	25, 84
Bibb Seat Dressers	124, 125
Bibb Seat Tool Set	15
Big Dave Auger	158
Bit Set	51
Blade Type Internal Wrench	18
Blaze Burner Torch Kit	144
Blow Bags	45
Blow Guns	95
Blue Monster Citrus Scrubbing Towels	195
Blue Monster Compression Seal Tape	146
Blue Monster Pipe Joint Compound	109
Blue Monster Teflon Tape	146
Boiler Repair Plugs	120
Boiler Tube Brushes	35, 36
Bolts	48, 168
Bonnet Socket	13
Bonnet Wrench	13
Box End Wrench Set	7, 105, 106
Box End Wrenches	7, 106
Box Flanges	128-130
Brackets	168-174
Brass Closet Spuds	177
Brass Closet Spud Wrenches	177
Brass Plugs	178
Bronze Couplings	44
Brown Sand Cloth	76
Brushes	31-36
Bucket Apron	79
Bucket Lid	79
Bucket Organizer	79
Bungee Cords	112
"Burch" Style Bushes	31
Burner Pipes	82

C

Cable Cutter	10
Cable Saws	140
Cable Ties	113
Calci Solve	110
Calfonex Pipe Break	109
Calking Tools	1
Candles, Plumber	125
Carrier Bracket	170
Carton Sealing Tape	146
Cast Iron Bar Grates	193
Cast Iron Closet Flanges	193
Cast Iron Hangers	54
Cast Iron Repair Clamps	42
Cast Iron Soil Pipe Strainers	193
Catch Cloths	124
Caulking Gun	110

C Continued PAGE

Cement Trowels	137
Chalk Line	75
Chalk Line Reels	75
Chalk, Powdered	75
Channellocks	7-11, 96, 104, 106
Check Valves, Sump Pump	83
Chemicals	108-110
Chisels	1, 2, 20
Clamps	12, 42, 43, 52, 53
Clean-Out Plug Wrenches	14, 16, 17
Clean-Out Plugs-Brass	178
Clean-Out Plugs-Lead	164
Clear Vinyl Tubing	188
Clip Gun	194
Clips	194
Closet Augers	157, 158
Closet Bolts	140
Closet Flanges	106, 193
Closet Flange Spacers	107
Closet Seat Wrench	14
Closet Spuds	177
Closet Spud Nut Wrench	177
Closet Supply Tubes	176
Collars	193
Combination Squares	138
Combination Wrench Sets	103-106
Combination Wrenches	15, 103-106
Combo Drive Tool	123
Compass Saw Blades	26
Compass Saw Handles	26
Compound Gauges	59
Compression Sleeve Puller	13
Concrete Gads	1
Condensate Drain Cleaner	139
Conduit Clamps	55
Copper Test Plugs	26-30
Cotton Swab	34
Coupling Nuts	179
Couplings	44
Crete® Sleeves	107
Crimpers	122, 161, 162
Crimping Tools	10, 11, 122, 161, 162
Crow Foot Wrenches	100, 102
Curtain-Rod Holders	138
Cylinders	142, 187

D

Deburring Tools	95
Decorator Handles	77
Decrimping Tool	161
Diaphragm Gauges	61
Dielectric Unions	158
Dies	74
Digital Thermometer	64

D Continued PAGE

Dishwasher Branches	191
Dishwater Connectors	176
Dishwasher Connector Kit	120
Disposer Connector Kit	120
Diverter Spouts	181-183
Diverter Valves	181-183
Dividers	123
Do-More Saw Handle	26
Double End Drills	67
Double Flare Tools	88-91
Double Test Plugs	28, 29
Douglas Flush Valves	190
Dr. Fixit Flushers	45
Drain Cleaner	139, 157, 158
Drain Jets	45
Drain Solve	110
Drain Wrenches	15
Drains, Lavatory	190, 191
Drift Plugs	124
Drill Bits	65-70
Drill Kits	65, 67-69
Drop Head Augers	158
Drop Head Snakes	155-158
Drop-In Anchors	47
Drum Faucets	95
Drum Trap Covers	167
Drum Trap Plug Wrenches	17
Dry Wall Anchor Kits	46, 47
Dryer Vent Kits	174
Duct Puller, Pincher	123
Duct Hangers	171-174
Duct Holder	123
Duct Slicer	123
Duct Stretcher	123
Dynameter Test Plugs	28

E

Economy Brushes	31
Electrical Tape	146
Element Wrenches	16
Emery Cloth	76
Epoxy Paste	110
Epoxy Putty	110
Escutcheons	128-130
Eureka Plug Wrench	17
Expanding Tool	91
Extendo Augers	157, 158
Extension Covers	168
Extension Hose	29
Extractors	17-19

F

F.H.A. Plates	185
Fairmont Tongs	122

F Continued	PAGE
Faucet Adaptors	115-119
Faucet Aerators	115-119
Faucet Hole Covers	131
Faucet Nutcrackers	17
Faucet Seat Wrenches	15
Faucet, Ledge	183
Faucet Nut Saw	15
Faucet Washers	37
Feeler Bits	70
Fibre Glass Hammers	39
Fibre Glass Joint Runners	84
Fibre Glass Probe Rods	65
Filament Tape	146
File Handles	39
Files	38, 39
Fin & Coil Brush	34
“Fit All” Blades	84
Fitting Brushes	31-35
Fitting Trays	79
Fixture Hangers	54, 55
Flame Guards	186
Flanges	106, 107, 128-130
Flange Tool	15
Flare Nut Wrench Sets	105
Flare Nut Wrenches	105
Flaring Tools	88-91
Flashlight Bulbs	81
Flashlights	80
Flat Sewer Tapes	155
Flat Tube Nailers	54
Flex Combination Wrenches	106
Flex Duct Saddle	174
Flex Duct Webbing	174
Flex Hoses	82
Flexi-Drains	130
Flexible Connectors	176
Flexible Packing Hooks	85
Flexible Plumber Tools	155-158
Flip Drive	51
Flints	121
Float Balls	167
Float Rods	140
Floor & Ceiling Plates	128-130
Floor Drain Covers	167
Floor Drain Stoppers	26, 121
Floor Drain Wrenches	16
Flo-Thru Jet Swets	163, 164
Flue Brushes	35, 36
Flush Valve, Douglas	190
Folding Tools	123
Form-A-Gasket	108
Four In 1 Brush	33
Four In 1 Combination Wrench	15
Four In 1 Refill Kit	33

F Continued	PAGE
Four In 1 Screwdriver & Ratchet	150
Free-All Tool	120
Freeze® Free Cable	159
Freeze Kit	187
Freeze Kit Parts	187
Furnace Floor Base	142
Furnace Shields	142
Furnaces, Propane	142

G

GFCI Cords	78
Garbage Disposer Tool	120
Gas Detector	84
Gas Test Gauges	61, 84
Gas Valves	81
Gasket Cutters	165
Gasket Scrapers	19
Gaskets, No Putty	132
Gauge Glass	153
Gauge Glass Cutters	154
Gauge Glass Friction Washer	154
Gauge Glass Nuts	154
Gauge Glass Repair Kit	154
Gauge Glass Sets	154
Gauge Glass Washers	154
Gauges	57-64, 121
Gear Benders	93
Gloves	76, 136
Grab Bars	193
Grabbers	127
Graphite Packing Spools	188
“Grit Cloth”, Sand Screen	76

H

Hacksaw Blades	25
Hacksaw Frames	25
Hammer Drives	48
Hammer Flare Tools	90
Hammers	39, 40
Hand Bender, Ratchet	93
Hand Crimpers	122
Hand Notchers	123
Hand Seamers	12, 122
Handi Reamer	95
Handles, File	39
Handles, Valve Wheel	179
Handle Pullers	13
Hangables	54
Hanger Iron	55
Hanger Ring & Bolts	56
Hard Head Brushes	31
Hatches	39
Heat Shields	186
Heat Tape Reel	159
Heavy Duty Brushes	32

H Continued PAGE

Hex Head Screws	.50
Hex Key Sets	.151-153
Hex Nuts	.49
Hex Products	.151-153
High Speed Twist Drills	.66-68
Hole Saws	.71-73
Hose Adapters	.116-119
Hose Cap	.166
Hose Clamps	.177
Hose Connectors	.166
Hose Guides	.114
Hose Washer	.166
Hose Y	.166
Hot + Cold Water Fitting	.131
Hot Dam	.37
Hot Tappers	.192
Hyco Bar	.170
Hyco Pex Bracket	.171
Hyco Pex Mounting Kit	.170
Hyco Bar Supports	.171
Hydrant Keys	.181
Hydraulic Sewer Flushes	.45
Hydro-Gauges	.121

I

Ice Breakers	.165
Ice Maker Kits	.137
Impact Puller	.13
Imperial products	.30, 85-95
Inside Pipe Wrenches	.16-19
Inside Plastic Pipe Cutters	.141
Inspection Mirrors	.126, 127
Insurance Pad	.186
Internal Pipe Wrenches	.16-19
Iodon Floor Drain Covers	.167
Irwin Bits	.69

J

J-Hook	.53
Jack Utility Knife	.135
"Jet Swet"	.163, 164
"Jet Swet" Tape	.21
Joint Runners	.84

K

Key Caddy	.138
Key Ring Screwdriver	.147
Keys, Air Valve	.14, 181
Keys, Hydrant	.181
Keys, Sillcock	.14, 181
Keys, Water Meter-Street	.181
Kitchen, Pull Out Spray Head	.114
Kitchen, Pull Out Hose	.114
Klenk Snips	.24
Knives	.133-135

K Continued PAGE

Kollar Kaps	.107
KwikCut Cutters	.87
Kwik-Tite Wrenches	.93

L

"L" Key Sets	.152, 153
Ladles, Steel	.78
Last Drop Suction Gun	.139
Lavatory Hangers	.55
Lavatory Supply Tubes	.176
Lead Anchors	.47
Lead Clean Out Plugs	.164
Lead Pots	.78
Lead Working Tools	.124
LED Flashlights	.80
LED Inspection Mirrors	.126, 127
LED Work Lights	.80
Ledge Faucets	.183
Levels	.24
Lever Benders	.92, 93
Lift Rods	.140
Lighters	.121, 127
Liquid Filled Gauges	.61-63
Little Giant Pipe Crimper	.122
Little Mike	.158
Lock Nuts	.179
Log Lighters	.81
Long Barrel Wrench	.188
Lower Lift Rods	.140
Lufkin	.20-22
Lumber Crayons	.121

M

Machine Screw Taps	.73, 74
Magna-Lites	.127
Magnetic Drill Chucks	.51
Magnetic Levels	.24
Magnetic Pick Up Tools	.127
Magnetic Tapes	.21
Manifolds	.94
Mano Meter	.121
Marq II Test Plugs	.28
Masonry Drills	.65, 66
Masonry Pilot/Driver Kit	.65
Mechanical Contractors Gauges	.64
Mechanics Sets	.96
Mechanics Wire	.137
Mega Pro 15 In 1 Screwdrivers	.148
Mesh Clip Tool	.194
Mesh Clips	.194
Metal Hangers	.54
Metric Combination Wrench Set	.104
Metric Socket Sets	.100
Micro Lite Screwdriver	.150
Micro Tube Bender	.92

M Continued	PAGE
Mini Bar	20
Mini Drain Jet	45
Mini Knife	135
Mini Knife Blade	135
Mini Saw	25
Mirrors	126, 127
Mr. Ratchet	148
Multi-Angle Thermometers	63

N

Nail Pullers	20
Nipper	11
Nipple Boxes	79
No-Hub Torque Wrenches	30
No Putty Gaskets	132
Notchers	123
Nozzles	95
Number Drills	68
Number Drill Kits	68
Nut Driver Kits	148, 149
Nut Drivers	148, 149
Nylon Anchor Kits	46
Nylon Anchors	46
Nylon Tube Brushes	35, 36

O

O-Ring Donut	189
O-Ring Kit	109
O-Ring Pick	109
Oetiker Clamps	160
Offset Screwdrivers	147
Oil Cans	41
Oil Filter Plier	13
“Old Timer” Knives	133, 134
One Hole Pipe Straps	52
Open End Wrench Set	105
Open End Wrenches	105
Office Drill Kits	68
Office Drills	68
Outside Tubing Brushes	32, 33
Overflow Faceplates	180
Overflow Tubes	140

P

P & M Spud Wrench	16
P.O. Plug Wrench	16
P.O. Plugs	190, 191
P-Traps	130
Packing Hooks	85
Packing Tools	1
Paddle Bits	69
Patchables	45
Paving Hammers	40
Pedestal Sink Wrench	17
Penetrating Oil	109

P Continued

Pentagon Keys	181
Permatex Products	108, 109
Petersen Flushers	45
“Pex” Brackets	170-172
“Pex” Clamps	160
“Pex” Rings	160
“Pex” Staples	194
Pex Tools	160-162
Pigtail Syphons	56
Pilot Lighters	127
Pin Vises	67
Pinch Off Tools	11, 93
Pinch Tools	161
Pipe & Duct Holder	123
Pipe Cutters	86, 87, 140-142
Pipe End Grate	167
Pipe Hooks	51
Pipe Insulators	169, 173
Pipe Joint Compound	108, 109
Pipe Positioning Bracket	170
Pipe Pullers	13
Pipe Repair Clamps	42, 43
Pipe Repair Couplings	44
Pipe Repair Kit	45
Pipe Solder Clips	173
Pipe Straps	51, 52
Pipe Taps	73
Pipe Thawing Equipment	159, 165
Pipe Wrenches	4, 5, 17
Plastic Anchor Kits	46
Plastic Couplings	44
Plastic Floor & Ceiling Plates	128
Plastic Handle Screwdrivers	148, 149, 150
Plastic Hanger Strap	55
Plastic Hole Forms	107
Plastic Knock Out Plugs	30
Plastic P-Traps	130
Plastic Pipe Cutters	87, 140-142
Plastic Pipe Saws	140, 141
Plastic Plugs	178
Plastic Straps	52, 55
Plastic Test Plugs	29
Plastic Tub Boxes	108
Plastic Tube Cutters	87, 140, 141
Plastic Wedges	55
Pliers	3, 4, 8-14
Plumb Bobs	75
Plumbers Candle	125
Plumbers Chisels	1-3
Plumbers Rolls	76
Plumbers Scraper	124
Plumbers Trunk	139
Plumbing Tools	1, 2
Plungers	139

P Continued	PAGE
Pocket Sockets	149
Pocket Thermometers64
Pointing Trowels	137
Polar Solar Cords77
Polybutlene Crimping Tool	160-162
Polybutlene Decrimping Tool	161
Pop-Up And Waste	190, 191
Power Bit Sets51
Power Brushes33, 34
Power Cords77, 78
Power Deuce Brush33
Power Jaws4
Precision Screwdriver Kit	148
Pressure Gauges57-64
Pressure Jets45
Pressure Snubbers64
Pressure Temperature Test Plugs59
Probe Rods65
Propane Cylinders	142
Propane Furnaces	142
Propane Gas Equipment	142-144
Propane Tips	143, 144
Prosnips22
Pro Vents111
Pry Bars20
Pull Out Spray Head & Hose114
Pullers13
Pulse Auger158
Punches2, 3
Putty Knives135
PVC Caddy109
PVC Hangers53, 54
PVC Nipple Extractor17

Q

Quad Box78
Quadnector Cords77
Quick Drain Wrench15
Quick Read Tape21
Quick Twist Brushes31

R

Radiator Handles	192
Radiator Nipple Wrench16
Radiator Valve Tool164
Ram Bit175
Rapid Wrench106
Ratch-Cut86
Ratchet Box Wrenches7, 106
Ratchet Hand Bender93
Ratchet Nut Driver	148, 150
Ratchet Screwdrivers	148, 150
Ratchet Tie Downs	111, 112
Ratchet Tube Cutters86
Ratchet Wrenches7, 93, 94, 106

R Continued	PAGE
Ratcheteer Wrench5
Ratcheting Pipe Wrench4, 5
Razorback™ Wrench16
RB Clip Gun194
RB Clips194
Reamers95
Red Line Gauge Glass153
Reddi-Strip Stapler194
Reddi-Strip Staples194
Reel Lights77
Refacing Tools124, 125
Reflector Light77
Reinforced Snakes155-157
Repair Clamps42, 43
Repair Coupling44, 45
Repair Plugs120
Rescue Tools11
Reseater Tools85, 124, 125
Rhopac Packing Hooks85
Richard Specialty Brushes32
Rinse Quik113, 114
Rod Buttons128
Rod Saws137
Roddick Wrenches17, 18
Roller Heads155
Roof De-Icer Kits159
Roto Cut86
Rubber Cushion Grip Screwdrivers	148, 150
Rubber Hammers40
Rubber Joint Runners84
Rubber Strap Wrenches17
Rubber Straps112
Rulers20-22
Rules20-22

S

Safety Goggles40
Sand Cloth76
Sand Pads76
Sand Screen Cloth76
Sanding Glove76
Saws140, 141
Schrade Cutlery Knives133, 134
Scratch Awls124
Scratch Brushes34
Screw Extractors16-19
Screw Starters147
Screwdrivers147-150
Screws48, 50
Scribes124
Scrubbing Towels195
Seamers12, 122
Seat Dressers124, 125
Self Drilling Anchors47

S Continued	PAGE
Self Feed Wood Boring Bits	175
Service Manifolds	94
Sewer Flushers	45
Sewer Stops	121
Sewer Tapes	155
Sheet Metal Screws	50
Sheet Metal Tools	12, 122, 123
Shower Arms	131
Shower Drains	190, 191
Shower Heads	189
Shower Rod Holders	138
Shower Rods	138
Shower Valve Socket Set	16
Silicone Form-A-Gasket	108
Silicone Lubricant	109
Sillcock Keys	14, 181
Sindell Sewer Stops	121
Sink Drains	190
Sink Spray Heads	113, 114
Sink Strainer Wrenches	15
Six In 1 Brush	33
Six In 1 Screwdriver	150
Sizing Tools	90
Skinner Clamps	42
Slip & Lock Nut Wrench	15
Slip Joint Double Wye	131
Slip Nut Washers	132
Slip Nuts	132
Sloan Tailpiece Tool	192
Smitties	151
Snakes	155-158
Snap Fittings	118, 119
Snap Lock Punches	123
Snap-N-Slide Bracket	172
Snap Ring Pliers	11
Snifter Valves Snips	84
Snips	23, 24
Snubbers	64
Soapstone	120
Soapstone Holders	120
Socket Savers	175
Socket Sets	96-103
Socket Wrench	106
Socket	96-103, 106
Soft Grip Brushes	31
Soft Jaw Pliers	14
Soil Pipe Strainers	193
Solder Rings	37
Solvent brushes	34
Spanner Flange	106
Spanner Wrenches	15
Spear Heads	155
Speedbor Bits	69
Speedbor Sets	69

S Continued	PAGE
Spiral Extractors	19
Split-One	128, 129
Spray Heads	114
Spring Benders	91
Spinkler Escutcheon	128
Sprinkler Gauges	60
Spud Buddy	192
Spud Chuck & Nipple Extractor	16
Spud Wrenches	16, 177
Square Pipe Dies	74
Squares	138
Stainless Steel Grab Bars	193
Stainless Steel Connectors	176
Stapler, Pex	194
Stem & Cartridge Puller	13
Stove Bolts	48
Stove Pipe Wire	137
Strainer, Basket	190
Strainer Tamer	15
Strainer Wrenches	15
Strap Wrenches	17
Street Keys	181
Strikers	121
Strippers, Wire	12
Stub Out Brackets	168, 169, 174
Stud Guards	184, 185
Stud Punch, Metal	169
Stud Supports	185
Stuvel Flush Valve Reseater	85
Suction Gun	139
Sump Pump Check Valves	83
Super Bar	20
Super Glue Adhesive	109
Super Red Sand Cloth	76
Suspension Clamps	53
Swaging Tools	90
Swivel Aerators	116
Swivel J Hooks	53

T

T-Bowl Shield	157
T-Cone Test Plugs	29
T-Torque Driver	148
T-Wrench Sets	152
T-Wrenches	151
Tab Brackets	172
Tank Levers	180
Tap Sets	74
Tap Wrenches	74
Tapes (Measuring)	20-22
Tapping Screws	50
Taps	73, 74
Teflon Packing	146
Teflon Paste	108, 109

T Continued PAGE

Teflon Tape	.145, 146
Teflon Thread Sealant	.108, 109
Telescoping Basin Wrenches	.14
Test Caps	.30
Test Plugs	.26-30
Test Plugs, Inflatable	.29
Theraltimeters	.59
Thermometers	.60, 63, 64
Tie Downs	.111, 112
Tie Wire	.137
Tie Wire Reel	.137
Tile Probes	.65
Tiny Tim Hack Saw Blades	.26
Tiny Tim Hack Saw Frames	.26
Tips, Acetylene	.144, 145
Tips, Propane	.143, 144
Tips, Tile Probe	.65
Toggle Bolts	.47
Toggle Wings	.47
Toilet Base Plates	.107
Toilet Flange Extenders	.106
Toilet Tank Float Balls	.167
Tool Bag	.79
Tool Boxes	.83
Torch Guard	.186
Torch Gun Kit	.144
Torch Holder	.142, 144
Torpedo Levels	.24
Torque Wrenches	.30
Tote Tray	.79
Tow Straps	.111
Trap Covers	.167
Trap Plugs	.120
Trouble Lights	.77
Trowels	.137
Tub Drain Boxes	.108
Tub Hangers	.54
Tub Spouts	.181-183
Tub Spud Wrench	.16
Tube Benders	.91-93
Tube Clamps	.52, 53
Tube Constrictors	.11, 86
Tube Cutters	.85-87
Tube Cutter Parts	.87
Tube Expanders	.90, 91
Tubing Brushes	.31-35
Turn Pins	.124
Twin Ell	.182
Twin Grip handles	.77
Twis-Tites	.26
Twist Drill Kits	.68
Twist Drills	.66, 67

U PAGE

"Uncle Henry" Knives	.134
Unibits	.70
Uni-fit Channellock Sets	.96, 106
Upper Lift Rods	.140
Utica Knives	.133
Utility Cases	.83
Utility Knife Blades	.135
Utility Knives	.135
Utility Straps	.111, 112

V

Vacuum Gauges	.58
Valve Wheel Handles	.179
Van Houtte Seat Wrench	.14
Vent Keys	.181
Vinyl Tubing	.188
Vise Grips	.11, 12









W

Washers, Faucet	.37
Washers, Flat	.49
Washing Machine Connectors	.176
Washing Machine Pans	.195
Wassi Plugging Kits	.164
Waste Connectors	.132
Water Closet Bracket	.170
Water Closet Ring Extension	.106
Water Heater Pans	.194, 195
Water Level Gauges	.60
Water Main Calkers	.1
Water Meter Keys	.181
Water Test Gauges	.84
Wedges	.55
Wells	.63
Wet Cut Sand Cloth	.76
Wheel Handles	.179
Whistle Free Flex Hoses	.82
White Sand Cloth	.76
Wiping Cloths	.124
Wire Cleaning Brush	.34
Wire Connectors	.188
Wire Strippers	.12
Wiss Snips	.23
Wood Bits	.69, 70, 175
Wood Handle Dope Brush	.33
Wood Handle Fitting Brush	.31
Wood Screws	.48
Work Lights	.80
Wrenches	.4-10, 14-18
Wright Tools	.96-105

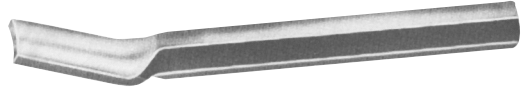

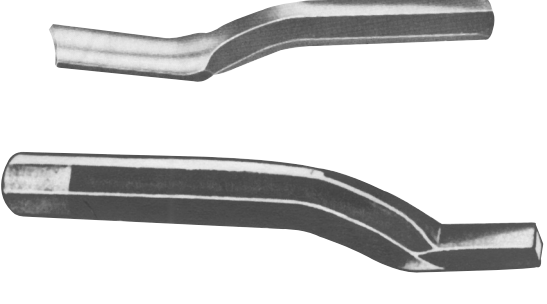

XYZ

Yarning Irons	.1
---------------	----



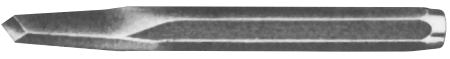
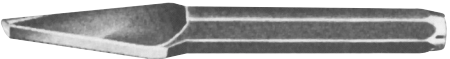

PLUMBING TOOLS

	CAT. NO.	MFG. NO.	STOCK SIZE	BLADE WIDTH	BLADE LENGTH	OVERALL LENGTH	BOX QTY.	VOL. QTY.
	CEILING CALKER							
	R100100	130	5/8"	11/16"	1 5/8"	14"	(1)6	6
	CURVED PONY CALKERS (Inside & Outside)							
	R100200	21 1/2 In	5/8"	5/8"	1 1/4"	4 1/2"	(1)6	6
	R100300	21 1/2 Out	5/8"	5/8"	1 1/4"	4 1/2"	(1)6	6
	BROAD CURVED NOSE CALKING IRON							
	R100400	110	5/8"	1 1/2"	2"	8 1/2"	(1)6	6
	LEFT & RIGHT CALKERS							
	R100500	132-L	5/8"	3/4"	7"	10"	(1)6	6
	R100600	132-R	5/8"	3/4"	7"	10"	(1)6	6
	LONG CALKERS (Inside & Outside)							
	R100700	33 1/2 In	1/2"	3/4"	1 1/2"	6 1/2"	(1)6	6
	R100800	33 1/2 Out	1/2"	3/4"	1 1/2"	6 1/2"	(1)6	6
	R100900	33 5/8 In	5/8"	7/8"	1 3/4"	7"	(1)6	6
	R101000	33 5/8 Out	5/8"	7/8"	1 3/4"	7"	(1)6	6
	LONG GASKET CALKERS							
	R101100	131 5/8	5/8"	7/8"	4"	9 1/2"	(1)6	6
	OFFSET CALKERS (Inside & Outside)							
	R101300	033 1/2 In	1/2"	3/4"	1 1/2"	6 1/2"	(1)6	6
	R101400	033 1/2 Out	1/2"	3/4"	1 1/2"	6 1/2"	(1)6	6
	R101500	033 5/8 In	5/8"	7/8"	1 5/8"	7"	(1)6	6
	R101600	033 5/8 Out	5/8"	7/8"	1 5/8"	7"	(1)6	6
	WATER MAIN CALKERS							
	R101700	109	3/4"	1"	2 11/16"	8"	(1)6	6
	R101705	In 1/4" Thick	3/4"	7/8"	-	8 1/2"	(1)6	6
	R101710	Out 1/4" Thick	3/4"	7/8"	-	8 1/2"	(1)6	6
	R101715	3/8" Thick	7/8"	7/8"	-	8 1/2"	(1)6	6
	R101720	1/2" Thick	7/8"	7/8"	-	8 1/2"	(1)6	6
	R101725	5/8" Thick	7/8"	7/8"	-	8 1/2"	(1)6	6
	R101730	3/4" Thick	1"	7/8"	-	8 1/2"	(1)6	6
	R101735	7/8" Thick	1"	7/8"	-	8 1/2"	(1)6	6
	SPRING YARNING IRONS							
	R101900	6 1/2 X 12	1/2"	5/8"	6 1/2"	12"	(1)6	6
	OFFSET YARNING IRONS							
	R102400	14 1/2 X 12 1/2	1/2"	5/8"	6 3/4"	13"	(1)6	6
	R102500	14 5/8 X 13	5/8"	11/16"	7 1/4"	16"	(1)6	6
	CONCRETE GADS							
	R102800	84 3/4	3/4"	-	-	12"	(1)6	6
	R102900	84 7/8	13/16"	-	-	12"	(1)6	6
	R103000	84-1	15/16"	-	-	12"	(1)6	6
	BULL POINT							
	R103100	-	3/4"	-	-	12"	(1)6	6



RICHARD SPECIALTY CO., INC.

CHISELS AND PUNCHES		CAT. NO.	MFG. NO.	CUT	POINT	STOCK	LENGTH	BOX QTY.	VOL. QTY.
COLD CHISELS									
	R103200	3/16		1/4"	-	3/16"	4 7/8"	(1)6	6
	R103300	1/4		5/16"	-	1/4"	5 1/8"	(1)6	6
	R103400	5/16		3/8"	-	5/16"	5 3/8"	(1)6	6
	R103500	3/8		7/16"	-	3/8"	5 1/2"	(1)6	6
	R103600	7/16		1/2"	-	7/16"	6"	(1)6	6
	R103700	1/2		5/8"	-	1/2"	6 5/8"	(1)6	6
	R103800	5/8		3/4"	-	5/8"	7"	(1)6	6
	R103900	3/4 X 8		7/8"	-	3/4"	8"	(1)6	6
	R104000	3/4 X 12		7/8"	-	3/4"	12"	(1)6	6
	R104100	3/4 X 18		7/8"	-	3/4"	18"	(1)6	6
	R104200	7/8 X 8		1"	-	13/16"	8"	(1)6	6
	R104300	7/8 X 12		1"	-	13/16"	12"	(1)6	6
	R104305	1 X 18		1"	-	13/16"	18"	(1)6	6
	R104400	1 X 8		1 3/16"	-	15/16"	8"	(1)6	6
CENTER PUNCHES									
	R104500	41 1/4		-	-	1/4"	4 1/2"	(1)6	6
	R104600	41 5/16		-	-	5/16"	4 5/8"	(1)6	6
	R104700	41 3/8		-	-	3/8"	4 7/8"	(1)6	6
	R104800	41 7/16		-	-	7/16"	5 1/4"	(1)6	6
	R104900	41 1/2		-	-	1/2"	5 5/8"	(1)6	6
	R105000	41 5/8		-	-	5/8"	6 1/4"	(1)6	6
CAPE CHISELS									
	R105100	72 1/4		1/8"	-	5/16"	5 1/2"	(1)6	6
	R105200	72 5/16		3/16"	-	3/8"	5 1/2"	(1)6	6
	R105300	72 3/8		1/4"	-	3/8"	5 1/2"	(1)6	6
	R105400	72 1/2		5/16"	-	1/2"	6 1/4"	(1)6	6
	R105500	72 5/8		3/8"	-	5/8"	7"	(1)6	6
	R105550	72 3/4		1/2"	-	3/4"	8"	(1)6	6
DIAMOND POINT CHISELS									
	R105600	76 1/4		1/8"	-	5/16"	5"	(1)6	6
	R105700	76 5/16		3/16"	-	3/8"	5 1/2"	(1)6	6
	R105800	76 3/8		1/4"	-	3/8"	5 3/4"	(1)6	6
	R105900	76 1/2		5/16"	-	1/2"	6"	(1)6	6
	R106000	76 5/8		3/8"	-	5/8"	7"	(1)6	6
	R106050	76 3/4		1/2"	-	3/4"	7"	(1)6	6
ROUND NOSED CHISELS									
	R106100	80 1/4		1/8"	-	5/16"	5 1/2"	(1)6	6
	R106200	80 5/16		3/16"	-	3/8"	5 1/2"	(1)6	6
	R106300	80 3/8		1/4"	-	3/8"	5 1/2"	(1)6	6
	R106350	80 1/2		5/16"	-	1/2"	6 1/4"	(1)6	6
	R106400	80 5/8		3/8"	-	5/8"	7"	(1)6	6
	R106450	80 3/4		1/2"	-	3/4"	8"	(1)6	6
PLUMBERS' CHISELS									
A favorite of plumbers because they can be put to the toughest usage. Made of special alloy chisel steel. Generous overall length to reach into hard-to-get-at spots.									
	R106500	5 7/16		5/8"	-	7/16"	9 1/2"	(1)6	6
	R106600	5 1/2		3/4"	-	1/2"	9 3/4"	(1)6	6
	R106700	5 5/8		1"	-	5/8"	10"	(1)6	6
	R106800	5 3/4		1 3/16"	-	3/4"	10 1/2"	(1)6	6
DRIFT, OR PIN PUNCHES									
	R106900	47 1/4X1/16		-	1/16"	1/4"	4 3/8"	(1)6	6
	R107000	47 1/4X3/32		-	3/32"	1/4"	4 3/4"	(1)6	6
	R107100	47 5/16X1/8		-	1/8"	5/16"	5 1/4"	(1)6	6
	R107200	47 5/16X5/32		-	5/32"	5/16"	5 5/8"	(1)6	6
	R107300	47 3/8X3/16		-	3/16"	3/8"	6 1/8"	(1)6	6
	R107400	47 7/16X7/32		-	7/32"	7/16"	6 1/2"	(1)6	6
	R107500	47 1/2X1/4		-	1/4"	1/2"	6 3/4"	(1)6	6
R107600	47 A set with one each of above in pouch.					7 1/2"	1	3	

CHISELS AND PUNCHES

	CAT. NO.	MFG. NO.	CUT	POINT	STOCK	LENGTH	BOX QTY.	VOL. QTY.
STARTING PUNCHES								
	R107700	50 3/16	-	1/16"	3/16"	4 1/8"	(1)6	6
	R107800	50 1/4	-	3/32"	1/4"	4 5/8"	(1)6	6
	R107900	50 5/16	-	1/8"	5/16"	5 1/8"	(1)6	6
	R108000	50 3/8	-	3/16"	3/8"	5 5/8"	(1)6	6
	R108100	50 7/16	-	7/32"	7/16"	6"	(1)6	6
	R108200	50 1/2	-	1/4"	1/2"	6 1/2"	(1)6	6
LONG TAPER PUNCHES								
	R108300	96 1/4	-	3/32"	1/4"	10"	(1)6	6
	R108400	96 5/16	-	1/8"	5/16"	10"	(1)6	6
	R108500	96 3/8	-	3/16"	3/8"	10"	(1)6	6
	R108600	96 7/16	-	7/32"	7/16"	10"	(1)6	6
	R108700	96 1/2	-	1/4"	1/2"	10"	(1)6	6
	R108800	96 5/8	-	5/16"	5/8"	10"	(1)6	6
	R108900	96 3/4	-	3/8"	3/4"	10"	(1)6	6
ALIGNING PUNCH								
	R109000	15 5/8	-	3/16"	5/8"	16"	(1)6	6
PUNCH & CHISEL HOLDER								
	R109010	2108	-	-	-	8 1/2"	(1)6	6
Holds punches and chisels up to 1" in diameter.								

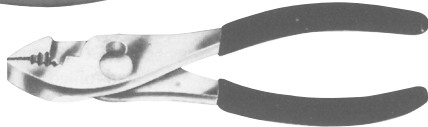
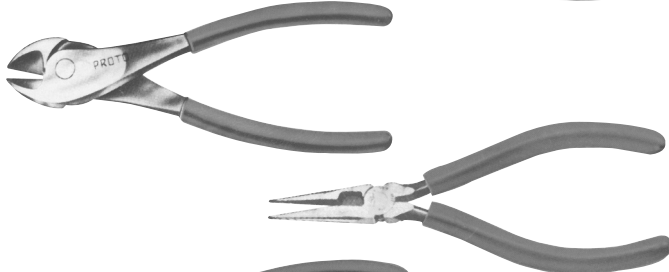
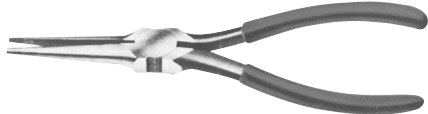
PLIERS

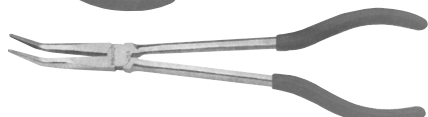
	CAT. NO.	MFG. NO.	LENGTH	BOX QTY.	VOL. QTY.
THIN JAW SLIP JOINT					
	R109100	202-G	6 1/2"	1	3
U.S.A. ECONOMY SLIP JOINT					
	R109300	G262	6"	1	5
	R109400	G263	8"	1	5
	R109500	G264	10"	1	5
HEAVY DUTY DIAGONAL CUTTING PLIERS					
	R109700	209-G	7 1/8"	1	3
NEEDLE NOSE SIDE CUTTING (With Side Cutter)					
	R109800	226-G	6 13/16"	1	3
LONG THIN NEEDLE NOSE PLIERS					
	R109900	222-G	6 7/8"	1	3
	R109910	225-G	6 1/4"	1	3
	R109920	240-G	11 1/2"	1	3
	R109930	241-G	11 3/8"	1	3

PLIERS

CAT. NO.	MFG. NO.	LENGTH	BOX QTY.	VOL. QTY.
----------	----------	--------	----------	-----------

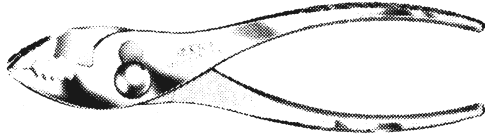

REGULAR SLIP JOINT

R110100	275	5 3/8"	1	3
R110200	276	6 3/8"	1	3
R110300	278	8"	1	3
R110400	280	10"	1	3

CAT. NO.	MFG. NO.	LENGTH	MAX. OPENING	BOX QTY.	VOL. QTY.
----------	----------	--------	--------------	----------	-----------

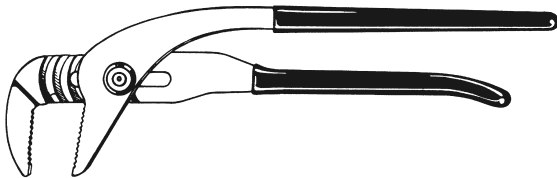

POWER TRACK

Machine tongue and grooved, eliminates wear and strain on bolt. Jaws angle 90° to create up to 20% more leverage than conventional 32° angled jaws. Pipe wrench style teeth. Satin chrome finish.

R110500	G297	10"	2 1/8"	(1)5	5
---------	------	-----	--------	------	---

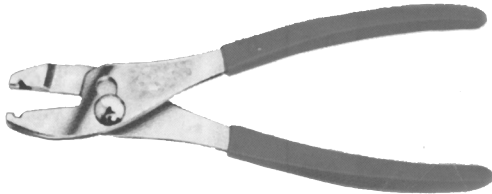

HOSE CLAMP PLIERS - CORBIN

R110700	G260	8"	-	1	3
---------	------	----	---	---	---

PIPE WRENCHES

CAT. NO.	MFG. NO.	LENGTH	MAX. PIPE SIZE	BOX QTY.	VOL. QTY.
----------	----------	--------	----------------	----------	-----------

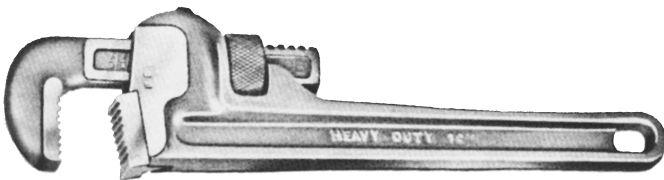

PIPE WRENCHES - IMPORTED

Forged alloy steel jaws with ductile cast iron handle. Free floating hook jaws give instant grip and release.

R111200	—	8"	1"	1	6
R111300	—	10"	1 1/2"	1	6
R111400	—	12"	2"	1	6
R111500	—	14"	2"	1	6
R111600	—	18"	2 1/2"	1	4
R111700	—	24"	3"	1	4

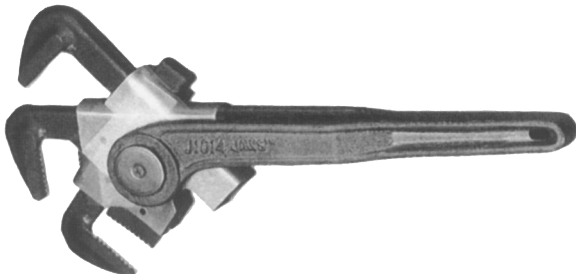

POWER JAWS™ (RATCHETING PIPE WRENCH)

R111750	J1010	10"	1 1/2"	1	6
R111755	J1014	14"	2 1/2"	1	6

PIPE WRENCHES



QUICK ADJUSTING PIPE WRENCH

Ideal for pipe up to 1 1/2". Slim jaw profile gets into tight spaces. Ratches quickly to work surface.

CAT. NO.	MFG. NO.	LENGTH	MAX. PIPE SIZE	BOX QTY.	VOL. QTY.
R112650	274001	11"	1 1/2"	1	2

ADJUSTABLE WRENCHES



RATCHET TYPE ADJUSTABLE

RATCHETEER™ WRENCH

CAT. NO.	MFG. NO.	MAX. OPENING	LENGTH	FINISH	BOX QTY.	VOL. QTY.
R112700	9600	3/8" - 1 5/16"	9"	Chrome	1	5

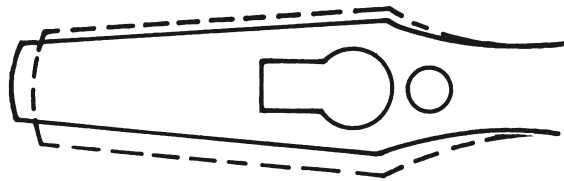

STANDARD - PROTO

Proto adjustable wrenches are hot forged from special alloy steel and are available in both chrome and black industrial finish. Jaw design provides greater strength and better fit on both square and hex nuts. Thinner head gets into tighter places. Rugged I-beam handle and reinforcement of critical stress areas ensure maximum strength and long service.

R113000	704	1/2"	4"	Chrome	(1)6	6
R113100	706	15/16"	6"	Chrome	(1)6	6
R113200	708	1 1/8"	8"	Chrome	(1)6	6
R113300	710	1 5/16"	10"	Chrome	(1)6	6
R113400	712	1 1/2"	12"	Chrome	(1)6	6

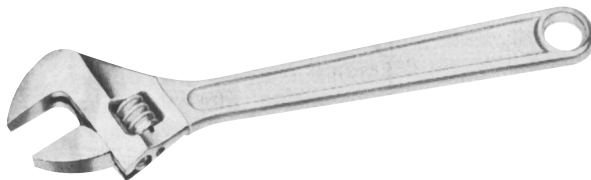

R113500	715	1 11/16"	15"	Chrome	1	2
R113600	718	2 1/16"	18"	Chrome	1	2
R113800	724	2 7/16"	24"	Chrome	1	2

R113900	704S	1/2"	4"	Black	(1)6	6
R114000	706S	15/16"	6"	Black	(1)6	6
R114100	708S	1 1/8"	8"	Black	(1)6	6
R114200	710S	1 5/16"	10"	Black	(1)6	6
R114300	712S	1 1/2"	12"	Black	(1)6	6



R114400	715S	1 11/16"	15"	Black	1	2
R114500	718S	2 1/16"	18"	Black	1	2
R114700	724S	2 7/16"	24"	Black	1	2

ADJUSTABLE WRENCHES

CAT. NO.	MFG. NO.	MAX. OPENING	LENGTH	FINISH	BOX QTY.	VOL. QTY.
----------	----------	--------------	--------	--------	----------	-----------

IMPORTED - QUALITY

Precision ground jaws. Flush ground tip. Accurately milled knurled adjusting nut for smooth, easy jaw adjustment and positive retention. Hot forged alloy steel. CHANNELLOCK'S advanced new 22.5° adjustable wrenches are manufactured in Spain in an ISO certificate facility to our most rigorous standards. They exceed ASME B 107.8M, B.S. 6333 and DIN 3117 standards.



R114800 - R115320



R115500 - R115530



R115540 - R115555



R115557 R115560



R115565 R115570



R115572 R115575

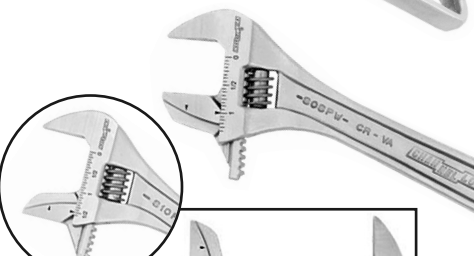

R115580 - R115595

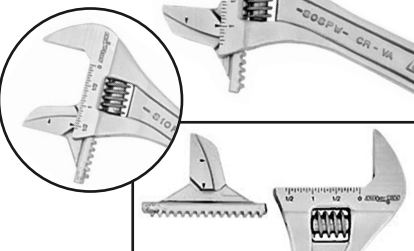

Reversible Jaw for Work on Bolts and Round Stock

R114800	804	33/64"	4"	Chrome	(1)5	5
R114900	806W	15/16"	6"	Chrome	(1)5	5
R115000	808W	1 3/16"	8"	Chrome	(1)5	5
R115100	810W	1 3/8"	10"	Chrome	(1)5	5
R115200	812W	1 1/2"	12"	Chrome	(1)5	5
R115300	815	1 11/16"	15"	Chrome	1	2
R115310	818	2 1/8"	18"	Chrome	1	2
R115315	824	2 7/16"	24"	Chrome	1	2
R115320	830	3"	30"	Chrome	1	2
R115500	804N	33/64"	4"	Black	(1)5	5
R115505	806NW	15/16"	6"	Black	(1)5	5
R115510	808NW	1 3/16"	8"	Black	(1)5	5
R115515	810NW	1 3/8"	10"	Black	(1)5	5
R115520	812NW	1 1/2"	12"	Black	(1)5	5
R115525	815N	1 11/16"	15"	Black	1	2
R115530	818N	2 1/8"	18"	Black	1	2

CUSHION GRIP

R115540	806WCB	15/16"	6"	With Grip	(1)5	5
R115545	808WCB	1 3/16"	8"	With Grip	(1)5	5
R115550	810WCB	1 3/8"	10"	With Grip	(1)5	5
R115555	812WCB	1 1/2"	12"	With Grip	(1)5	5

WIDEAZZ

R115557	6WCB	1 11/32"	6"	With Grip	(1)5	5
R115560	8WCB	1 1/2"	8"	With Grip	(1)5	5

EXTRA SLIM JAW

R115565	6SWCB	1 11/32"	6"	With Grip	(1)5	5
R115570	8SWCB	1 1/2"	8"	With Grip	(1)5	5

R115572	804S	33/64"	4"	Chrome	(1)5	5
R115575	806SW	15/16"	6"	Chrome	(1)5	5

REVERSIBLE JAW

R115580	806PW	1 5/16"	6"	Chrome	(1)5	5
R115585	808PW	1 3/16"	8"	Chrome	(1)5	5
R115590	810PW	1 3/8"	10"	Chrome	(1)5	5
R115595	812PW	1 1/2"	12"	Chrome	(1)5	5

RATCHETING BOX WRENCHES

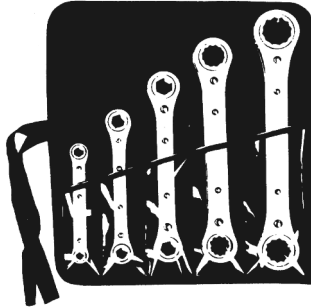

RATCHETING BOX WRENCHES - STRAIGHT

Ideal for working in confined areas and when speed is essential. Wrench is fully reversible for removing or installing fasteners.

CAT. NO.	MFG. NO.	SIZE OPENINGS	POINTS	LENGTH	BOX QTY.	VOL. QTY.
R115600	873	1/4" X 5/16"	6	4 1/2"	(1)6	6
R115700	874	3/8" X 7/16"	6	5 1/2"	(1)6	6
R115800	875-B	7/16" X 1/2"	6	6 7/8"	(1)6	6
R115900	875	1/2" X 9/16"	6	6 3/4"	(1)6	6
R116000	876	5/8" X 11/16"	12	8"	(1)6	6
R116100	879	3/4" X 7/8"	12	9 1/4"	(1)6	6
R116200	877	5/8" X 3/4"	12	8 1/8"	(1)6	6
R116210	878	11/16" X 13/16"	12	9 1/4"	(1)6	6
R116215	880	13/16" X 15/16"	12	9 1/4"	(1)6	6
R116300	885 Kit-Straight (Consisting of 1 ea. (873, 874, 875, 876, 878))				1	2

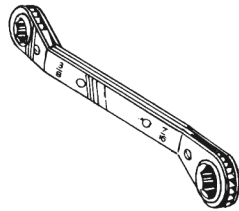
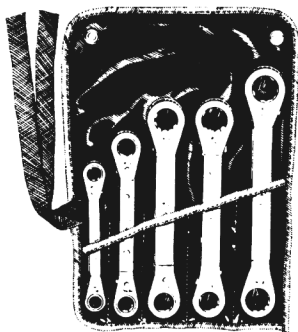

RATCHETING BOX WRENCHES - OFFSET

R116400	800	1/4" X 5/16"	-	4 3/32"	(1)6	6
R116410	801	3/8" X 7/16"	-	5 7/32"	(1)6	6
R116415	802	1/2" X 9/16"	-	6 15/32"	(1)6	6
R116420	803	5/8" X 11/16"	-	7 21/32"	(1)6	6
R116425	804	3/4" X 7/8"	-	8 3/4"	(1)6	6
R116430	806 Kit-Offset (Consisting of 1 ea. (800, 801, 802, 803, 804))				1	2



8 in 1 WRENCH SET

Does the work of 8 combination wrenches or sockets. Ratcheting/reversible.

R116435	841M	Metric	8mm X 10mm, 12mm X 13mm, 16mm X 17mm, 18mm X 19mm	(1)5	5
R116440	8415	SAE	5/16" X 3/8", 7/16" X 1/2", 9/16" X 5/8", 11/16" X 3/4"	(1)5	5

TONGUE AND GROOVE PLIERS

CAT NO.	MFG. NO.	LENGTH	JAW CAP.	BOX QTY.	VOL. QTY.
---------	----------	--------	----------	----------	-----------

R116500



SELF - GRIPPER

Grips like a pipe wrench but is easier to handle.

R116500	307	7"	1 5/8"	(1)5	5
R116600	410	9 1/2"	1 1/8"	(1)5	5
R116610	414	14"	2"	(1)2	4



R116600
R116610

SMOOTH JAW

Specially designed for use on plated fittings. Ideal for plumbers and home utility servicemen.

R116800	415	10"	2"	(1)5	5
---------	-----	-----	----	------	---

R116800



MITY MIDGET

A midget plier ideal for use on ignition and other small work.

R117000	424	4 1/2"	1/2"	(1)5	5
---------	-----	--------	------	------	---



R117000

POCKETSIZE

A "Junior Size" version of our fast-selling No. 420 Multi-Purpose plier. Handy, fit-in-pocket convenience.

R117200	426	6 1/2"	7/8"	(1)5	5
---------	-----	--------	------	------	---

R117200



R117400

MULTI-PURPOSE

Favorite of mechanics everywhere. Patented undercut channels.

R117400	420	9 1/2"	1 1/2"	(1)5	5
---------	-----	--------	--------	------	---

R117450
R117460

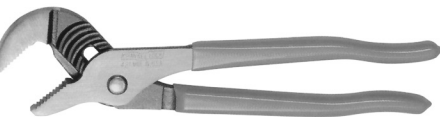

MULTI-PURPOSE WITH SAFE-T-STOP™

Lower jaw combines with expanded reinforcing rib to prevent handles from contacting each other. Patented SAFE-T-STOP™ feature prevents finger pinch.

R117450	421	9 1/2"	1 1/2"	(1)5	5
R117460	428	8"	1 1/2"	(1)5	5



R117600

R117800



BIG CHAMP

R117600	430	10"	2"	(1)5	5
---------	-----	-----	----	------	---

Large grip on big jobs in hard to reach places. Jaws are only 5/16" thin.

R117800	440	12"	2 1/4"	(1)5	5
---------	-----	-----	--------	------	---



R118100

A 16" and 20" giant with all the exclusive CHANNELLOCK features available.

R117900	460	16"	4 1/4"	(1)2	4
R118100	480	20 1/4"	5 1/2"	(1)2	4

TONGUE AND GROOVE PLIERS CAT. NO. MFG. NO. LENGTH JAW CAP. BOX VOL. QTY. QTY.

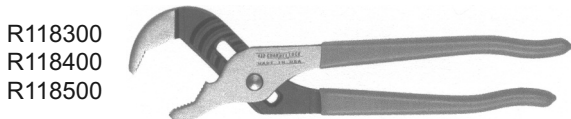

R118300
R118400
R118500

MULTI - PURPOSE PUMP V-JAWS

Curved-jaw multi-purpose plier for greater gripping power on curved objects.

R118300	422	9 1/2"	1 1/2"	(1)5	5
R118400	432	10"	2"	(1)5	5
R118500	442	12"	2 1/4"	(1)5	5

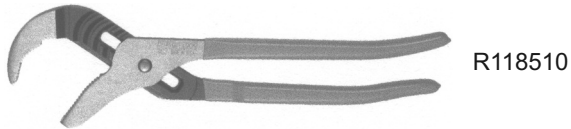

R118510

R118510	463	16"	4 1/4"	(1)2	4
R118520	483	20 1/4"	5 1/2"	(1)2	4



R118520

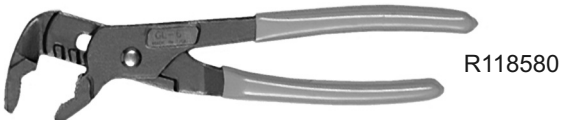

R118580

CHANNELLOCK GRIPLOCK

R118580	GL-6	6 1/2"	1 1/16"	(1)5	5
R118600	GL-10	10"	1 1/4"	(1)5	5
R118700	GL-12	12"	2"	(1)5	5

STANDARD PATTERN PLIERS CAT. NO. MFG. NO. LENGTH BOX VOL. QTY. QTY.



R118750

LONG NOSE PLIERS (With Cutter)

R118750	318	8"	(1)5	5
---------	-----	----	------	---



R118800

R118800	317	7 1/2"	(1)5	5
---------	-----	--------	------	---



R118900

R118900	326	6"	(1)5	5
---------	-----	----	------	---



R119000
R119010

DIAGONAL CUTTING PLIER (Lap Joint)

R119000	337	7"	(1)5	5
R119010	338	8"	(1)5	5



R119110

R119110	318WS	8 3/8"	(1)5	5
---------	-------	--------	------	---

STANDARD PATTERN PLIERS

CAT. NO.	MFG. NO.	LENGTH	BOX QTY.	VOL. QTY.
----------	----------	--------	----------	-----------

R119300



LINEMEN'S PLIER-ROUNDED NOSE (Side Cutter)

R119200	346	6"	(1)5	5
R119300	347	7"	(1)5	5
R119400	348	8 1/2"	(1)5	5
R119450	369CRFT	9"	(1)5	5



R119450

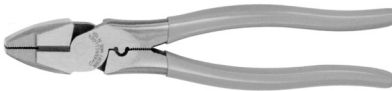

LINEMEN'S PLIER-BEVEL NOSE (Side Cutter)

R119600	3047	7"	(1)5	5
R119700	3048	8 1/2"	(1)5	5



R119800



WIREMASTER PLIER

R119800	349	9"	(1)5	5
---------	-----	----	------	---



R120000



END CUTTER

R119900	357	7"	(1)5	5
---------	-----	----	------	---



DIAGONAL CUTTING PLIER (Box Joint)

R120000	436	6"	(1)5	5
R120100	437	7"	(1)5	5

R120200



CURVED DIAGONAL CUTTING PLIER (Box Joint)

R120200	447	7 3/4"	(1)5	5
---------	-----	--------	------	---



SLIP-JOINT PLIER (Thin Nose)

R120300	516	6"	(1)5	5
---------	-----	----	------	---

R120400



CRIMPING TOOL

R120400	909	9 3/4"	(1)5	5
---------	-----	--------	------	---



CABLE CUTTER

Cuts copper up to 2/O soft copper and up to 4/0 aluminum.

R120500	911	9 1/2"	(1)5	5
---------	-----	--------	------	---

R120700



SLIP JOINT PLIERS (With Wire Cutter)

R120700	546	6"	(1)5	5
R120800	548	8"	(1)5	5
R120900	5410	10"	(1)5	5



STANDARD PATTERN PLIERS

CAT. NO.	MFG. NO.	LENGTH	BOX QTY.	VOL. QTY.
----------	----------	--------	----------	-----------



CONVERTIBLE SNAP RING PLIER

Serves external rings 1/2" to 2" internal rings 3/8" to 2"

R121000	927	7 1/2"	1	5
R121010	927T	Plastic Pouch w/tips	1	5

(Plastic Pouch contains five pairs of tips:
.038 Black-straight and 90° bend; .047 Silver-straight and 90° bend; .070 Gold-straight only.)

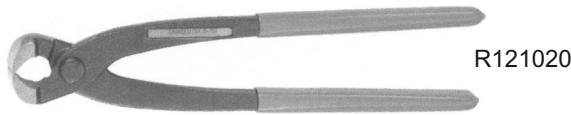

CONTRACTORS NIPPER

R121020	35-250	10"	(1)5	5
R121025	35-300	12"	(1)5	5



RESCUE TOOLS

Spring and lock feature allows easy one hand operation. Jaw design accomodates many shapes and provides maximum grip. Shuts off gas safety valves, pries open windows and doors. Spanner wrench tightens and loosens hose couplings.

R121030	86		(1)5	5
R121035	87		(1)5	5

WISE GRIPS

CAT. NO.	MFG. NO.	LENGTH	JAW THICK	JAW ADJ.	BOX QTY.	VOL. QTY.
----------	----------	--------	-----------	----------	----------	-----------

R121100 -
R121400



WISE-GRIP THIN NOSE (Curved Jaws, With Wire Cutter.)

R121100	4WR	4 1/4"	1/4"	15/16"	(1)5	10*
R121200	5WR(C5CV)	5"	1/4"	1 1/8"	(1)5	10*
R121300	7WR(C7CV)	7"	5/16"	1 5/8"	(1)5	10*
R121400	10WR(C10CV)	10"	3/8"	1 7/8"	(1)5	10*



R121500
R121600

WISE-GRIP THIN NOSE (Curved Jaws Without Wire Cutter.)

R121500	7CR	7"	5/16"	1 5/8"	(1)5	10*
R121600	10CR	10"	3/8"	1 7/8"	(1)5	10*

R121700
R121800



WISE-GRIP REGULAR MODEL (Straight Jaws Without Wire Cutter.)

R121700	7R(C7SV)	7"	7/16"	1 1/8"	(1)5	10*
R121800	10R(C10SV)	10"	5/8"	1 1/4"	(1)5	10*



R121900

LOCKING PINCH-OFF TOOL

R121900	RR	7"	1/4"	1"	(1)5	10*
---------	----	----	------	----	------	-----



R122000

CHAIN CLAMP WRENCH (Vise-Grip With Easy Release.)











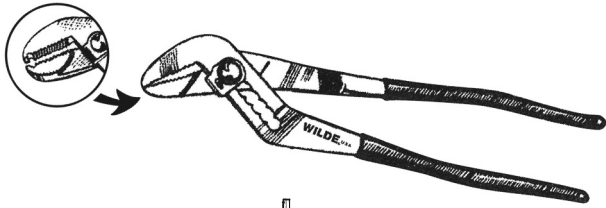

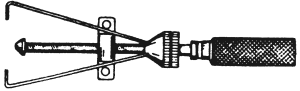
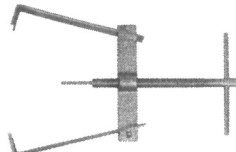
R122000	20R(C20CH)	18"	-	-	(1)5	10*
R122010	20Rep	Replacement chain for above.			(1)5	10*

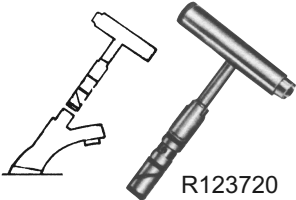
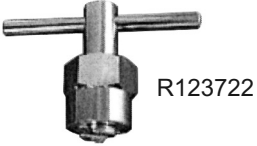
RICHARD SPECIALTY CO., INC.

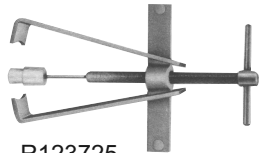
WISE GRIPS		CAT. NO.	MFG. NO.	LENGTH	JAW THICK	JAW ADJ.	BOX QTY.	VOL. QTY.
R122200 - R122310		"C" CLAMPS (Vise-Grip With Easy Release.) Adjusts to the proper opening by means of end screw and then locks onto work by a squeeze of the hand. Permits user to hold work with one hand and apply clamp with the other.						
		R122200	11R(C11CCV)	11"	-	3 3/4"	(1)5	10*
		R122300	18R	18"	-	7"	(1)5	10*
R122315 - R122330		"C" CLAMPS (With Swivel Pads.)						
		R122315	6SP(C6CCSV)	6"	-	2 1/8"	(1)5	10*
		R122320	11SP(C11CCSV)	11"	-	4"	(1)5	10*
		R122325	18SP	18"	-	8"	1	10*
R122330	24SP	24"	-	10"	1	10*		
R122400		SHEET METAL WORKERS' TOOLS (Vise-Grip With Easy Release.)						
R122400	8R(C8SMV)	8"	3 1/8"	1 3/4"	1	10*		
R122500		WELDING CLAMPS (Vise-Grip With Easy Release.)						
R122500	9R(C9W)	9"	2 3/4"	1 5/8"	1	10*		
R122600 - R122800		LONG NOSE VISE-GRIP PLIERS						
R122600		4LN	4 3/4"	1/8"	1 3/4"	(1)5	10*	
R122700		6LN(C6NV)	6"	1/8"	2 1/4"	(1)5	10*	
R122800	9LN(C9NV)	9"	3/16"	3"	(1)5	10*		
R122400		BENT NOSE VISE-GRIP PLIERS 35° ANGLE						
R122840	12LC	-	-	3 1/8"	(1)5	10*		

*All Vise-Grips May Be Assorted For Volume Quantity.

PLIERS & WIRE STRIPPERS		CAT. NO.	MFG. NO.	LENGTH	BOX QTY.	VOL. QTY.
R122900		5-IN-1 TOOL CRIMPER Handles all popular solderless terminal types. Plastic dipped handles.				
R122900	908	8 1/4"	(1)5	5		
R122910		STRIPPER AND CUTTER				
R122910	958	6"	(1)5	5		
R123000		101-S with Spring				
R123000	101-S with Spring	5"	(1)12	12		
R123100		2-in-1 Cutter/Stripper Strips 26-16 AWG				
R123100	2-in-1 Cutter/Stripper Strips 26-16 AWG		1	12		
R123200		2-in-1 Cutter/Stripper Strips 14-10 AWG				
R123200	2-in-1 Cutter/Stripper Strips 14-10 AWG		1	12		
R123100 and R123200 Self-Adjust to Wire						

PLIERS & PULLERS		CAT. NO.	MFG. NO.	SIZE	BOX QTY.	VOL. QTY.
ANGLE NOSE PLIERS ECONOMY LINE (With Grips)						
	R123500	G251		6 3/4"	(1)5	5
	R123600	G253		10"	(1)5	5
	R123610	G254		11"	(1)5	5
FAUCET HANDLE PULLER						
	R123710	50-1050 IMPORTED		5"	1	5
	R123712	DELUXE PULLER		6"	1	5
	R123715	IMPACT PULLER		7"	1	5
	R123718	TRI-JAW HANDLE PULLER			1	5
	R123720	STEM & CARTRIDGE PULLER			1	5
	R123722	MOEN CARTRIDGE REMOVAL TOOL			1	5
	R123725	COMPRESSION SLEEVE PULLER For 1/2" copper tubing. Removes compressed brass sleeves and nuts without punching hole in wall to sweat in new piece of copper in order to replace an angle stop.			1	5
<i>*Sleeve Puller and Handle Puller Sold Separately.</i>						
	R123728	COMPRESSION SLEEVE PULLER			1	3
	R123730	BONNET SOCKET Bonnet socket for use in extracting Delta R11000 Diverter Valve			1	5
	R123732	BONNET WRENCH Bonnet wrench for use in extracting Delta R10000, Delta R1300/1700 Series, Brizo R60000 & Peerless R10000 Shower Valves			1	5
	R123740	PIPE PULLERS				
	R123742	1 1/4 - 1 1/2" HEAVY DUTY DUAL PIPE PULLER			1	5
	R123745	2" HEAVY DUTY DUAL PIPE PULLER			1	5





PVC/OIL FILTER PLIER		CAT. NO.	MFG. NO.	SIZE	CAPACITY	BOX QTY.	VOL. QTY.
	R123800	209		9"	1 3/4"-3 1/2"	(1)5	5
	R123810	212		12"	2 3/4"-4 1/4"	(1)5	5
	R123820	215		15"	2 1/2"-5 1/2"	(1)5	5



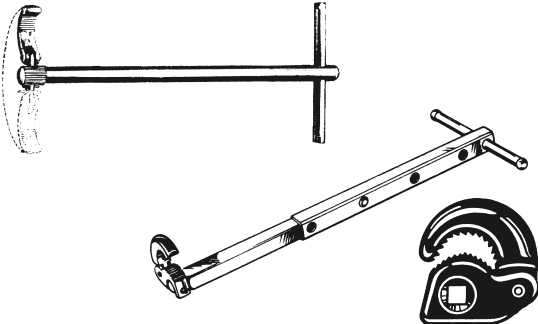



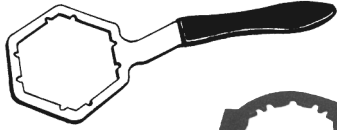

RICHARD SPECIALTY CO., INC.

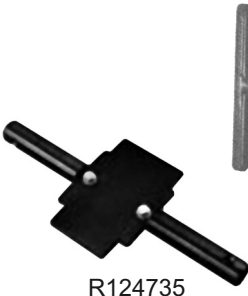
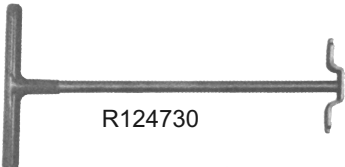
SOFT JAW PLIER		CAT. NO.	MFG. NO.	SIZE	CAPACITY	BOX QTY.	VOL. QTY.
		R123850	GT-111	10"	2 1/2"	1	2
		R123855	GT-112	JAWS FOR GT-111		1	2
		R123860	GT-113	10"	2 1/2"	1	2
		R123865	GT-114	JAWS FOR GT-113		1	2

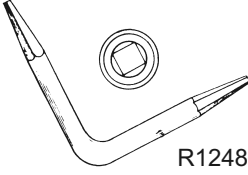
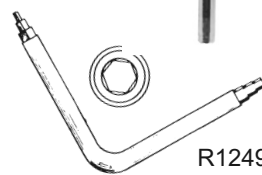
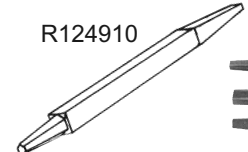
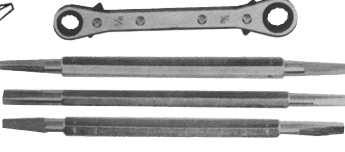
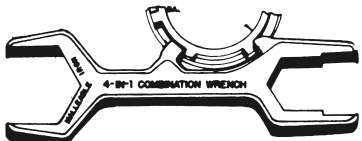
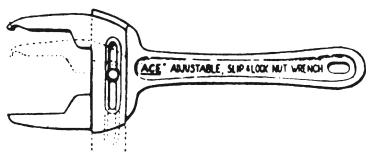
SILLCOCK KEY		CAT. NO.	SIZE		BOX QTY.	VOL. QTY.
	SILLCOCK KEY					
	R124200	4 in 1	1/4", 5/16", 11/32", 9/32"		1	12

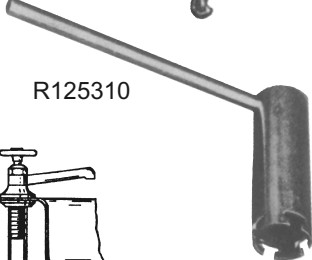
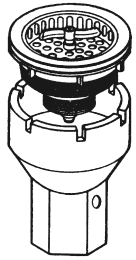
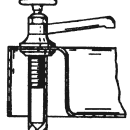
BASIN WRENCHES		CAT. NO.	LENGTH	JAW SIZE	BOX QTY.	VOL. QTY.
	BASIN WRENCH					
	Rustproof, bright nickle plated. The right tool for ledge-type lavatories. Jaw is locked into position by spring tension.					
	R124400	Regular	11"	-	1	3
	R124500	Jumbo	15"	-	1	3
	TELESCOPING BASIN WRENCH					
	R124610		10"-17"	1 1/4"	1	3
	R124615		10"-17"	1 7/8"	1	3
	R124625	Basin wrench attachment for 3/8" drive ratchet sets.			1	5

CLOSET, SINK & SHOWER WRENCHES		CAT. NO.	DESCRIPTION	BOX QTY.	VOL. QTY.
	VAN HOUTTE 14 IN 1 CLOSET SEAT WRENCH				
	Small, completely enclosed, rigid jaw wrench with both ends adaptable for use with a leverage pin, wrench, or ratchet wrench.				
	R124700	Fits 99% of all plastic and metal closet nuts.		1	24
	DRAIN WRENCH				
	R124705	Lavatory Nut Removal Tool		1	3
	R124710	Drain Wrench fits 3 1/2" plastic locknuts. Fits brass locknut on shower stall drains. Stamped steel. 13" overall length. Offset handle.		1	6
 R124710	 R124720	R124720	Fits hex nuts and all 4, 6 and 8 tab locking nuts on strainer drains. Square end of tool fits into internal locknut slots of all major plastic and brass drains.	1	6

CLOSET, SINK & SHOWER WRENCHES		CAT. NO.	MFG. NO.	SIZE/DESCRIPTION	LENGTH	BOX QTY.	VOL. QTY.
DRAIN WRENCH							
	R124730	R124730		Quick Drain Wrench		1	6
	R124735	R124735		Flange Tool for commercial sinks		1	3
FAUCET SEAT WRENCH							
	R124750	R124750		T-Bar Handle Seat Wrench		1	6
	R124800	R124800	1	Tapered	6"X6"	1	6
	R124900	R124900	2	6 Step	6"X6"	1	6
	R124910	R124910	1	Straight Hex & Square Tapered	7 1/2"	1	6
BIBB SEAT TOOL SET (NOT SHOWN)							
	R124930	R124930	1	Set includes (1) 3/8" X 7/16" ratcheting box wrench, (1) small hex/large hex tapered bibb seat tool, and (1) small square/large square no taper bibb seat tool.		1	4
4 IN 1 COMBINATION WRENCH							
	R125000	R125000		Fits 1 1/4", 1 1/2" and 2" spuds. Will fit all duo sink strainer lock nuts to 4".		1	3
SLIP & LOCK NUT WRENCH							
	R125100	R125100		Combination adjustable wrench for closet spuds and sink strainers up to 3 1/4" capacity.		1	3
SINK STRAINER WRENCHES							
	R125150	R125150		SINK STRAINER WRENCH		1	3
	R125205	R125205		SPANNER WRENCH - IMPORT		1	3
	R125310	R125310		STRAINER WRENCH		1	3
	R125320	R125320		STRAINER TAMER Fits 3 3/8" strainer locknut. 5 1/2" length. Made of tough LEXAN plastic, tightens most 2" brass shower drains.		1	6
	R125325	R125325		*P2KTO3 Strainer Wrench		1	3
	R125330	R125330		*P2KTO4 Jr. Strainer Wrench		1	3
	R125332	R125332		*P2KTO6 Faucet Nut Driver		1	3
	R125334	R125334		P2KST Set of 3 Tools (For use with drills.)		1	3
	R125340	R125340		FAUCET NUT SAW Always use a 3/8" drill with this tool, 7" long.		1	3

RICHARD SPECIALTY CO., INC.

CLOSET, SINK & SHOWER WRENCHES

CAT. NO.

SIZE

BOX VOL. QTY. QTY.

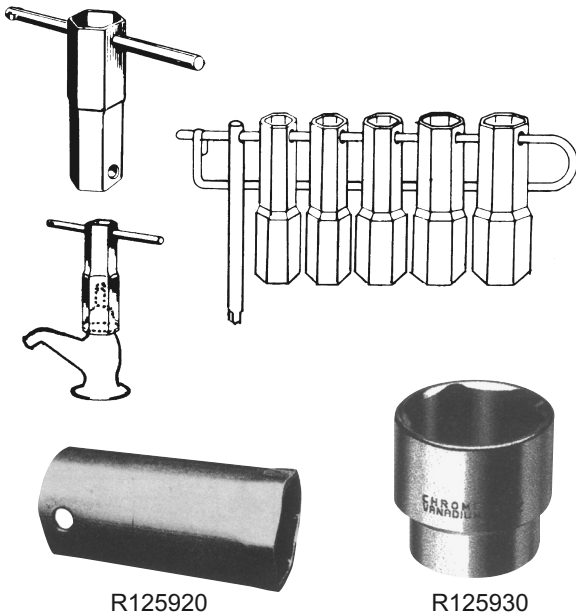

SHOWER VALVE SOCKET WRENCHES

Steel cadium plated extra-heavy wall. Each socket has 2 sizes, one at either end.

R125400	Shower Valve Set	1	4
R125500	21/32" X 27/32"	1	3
R125600	29/32" X 31/32"	1	3
R125700	1 1/32" X 1 3/32"	1	3
R125800	1 5/32" X 1 9/32"	1	3
R125900	1 11/32" X 1 7/16"	1	3

R125910	27/32" X 31/32" 6"Long	1	3
---------	------------------------	---	---

R125920	Element Wrench	1	3
---------	----------------	---	---

ELEMENT SOCKET WRENCH

R125930	1/2" Drive socket	1	12
---------	-------------------	---	----

EXTRACTOR & SPUD WRENCHES

CAT. NO.

SIZE/DESCRIPTION

BOX VOL. QTY. QTY.

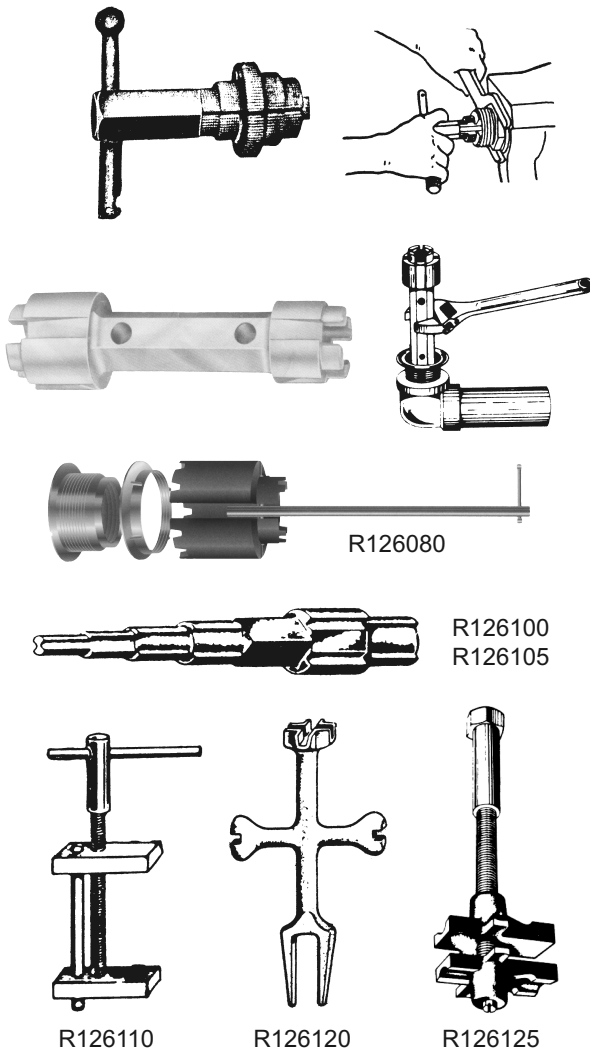

SPUD CHUCK & NIPPLE EXTRACTOR

For installing or extracting nipples and tubing of sizes 1" to 2" inclusive. Closet spud chuck for 1", 1 1/4", 1 3/8", 1 1/2", 2".

R126000	Holds all sizes to 2".	1	3
---------	------------------------	---	---

TUB SPUD WRENCH

Easily install or remove bath tub drains, even those without crossbars. Fits 1 1/2" and 2" closet spuds, fits 95% of all tub drains. Use either end tool.

R126010	Tub Spud Wrench	1	12
---------	-----------------	---	----

FLOOR AND SHOWER DRAIN WRENCH

R126080	Razorback™ Wrench	1	5
---------	-------------------	---	---

R126100	Radiator Nipple Wrench	1	6
---------	------------------------	---	---

R126105	Radiator Nipple Wrench -Import	1	6
---------	--------------------------------	---	---

R126110	Adjustable Internal Wrench	1	3
---------	----------------------------	---	---

R126120	P.O. Plug Wrench	1	3
---------	------------------	---	---

For large and small sink strainers, toilet bowl spud, etc.

R126125	Inside Pipe Wrench	1	3
---------	--------------------	---	---

For gripping inside of pipe and fittings from 1/2" to 3 1/2" diameters.

EXTRACTOR & SPUD WRENCHES

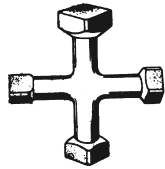

R126130

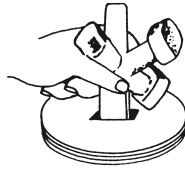

R126135

CAT. NO.	MFG. NO.	PIPE SIZE/ DESCRIPTION	BOX QTY.	VOL. QTY.
R126130		Drum Trap Plug Wrench 3/4", 1", 1 1/8", 1 3/8"	1	6
R126135		Eureka Cleanout Plug Wrench CSK slotted and square.	1	3

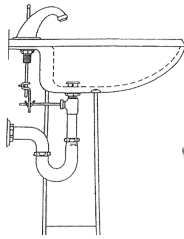

R126142

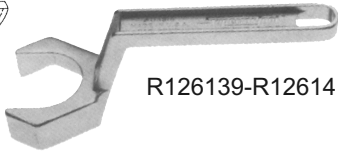

R126139-R126141

PEDESTAL SINK WRENCH

R126139		1 1/4"	1	3
R126141		1 1/2"	1	3



BALLCOCK WATERFILL VALVE WRENCH

R126142		Toilet Wrench	1	6
---------	--	---------------	---	---

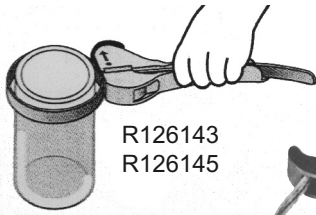

R126143
R126145

R126143		Strap Wrench Rubber 1/4" to 3 3/4"	1	6
R126145		Strap Wrench Rubber 3/8" to 5 1/2"	1	6

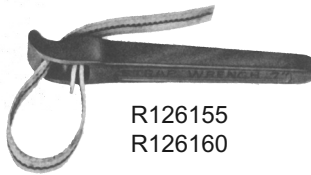

R126155
R126160

R126155		Strap Wrench - 7"	1	2
R126160		Strap Wrench - 11"	1	2



R126165



R126180



R126165		Faucet Quick Nutcracker	1	2
R126180		1/2" - 3/4" PVC Nipple Extractor	1	3

INTERNAL PIPE WRENCH - U.S.A.

Knurled eccentric engages the inside wall and provides positive grip.

R126200	203	3/8"	1	6
R126300	204	1/2"	1	6
R126400	206	3/4"	1	6
R126500	208	1"	1	6

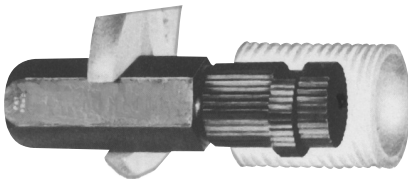

R126200 - R126500

200 "AK HANDY KIT"

Consists of one each 3/8", 1/2", 3/4", 1" sizes packed in vinyl case, provides assurance of having the right size on hand for plumbing work.

R126600	200	Complete Kit	1	4
---------	-----	--------------	---	---

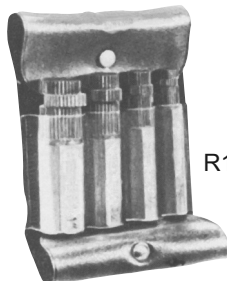

R126600

INTERNAL PIPE WRENCH - IMPORT

R126610		3/8" Wrench Import	1	6
R126615		1/2" Wrench Import	1	6
R126620		3/4" Wrench Import	1	6
R126625		1" Wrench Import	1	6
R126630		Kit Import	1	4

RICHARD SPECIALTY CO., INC.

EXTRACTOR & SPUD WRENCHES

CAT. NO.	MFG. NO.	PIPE SIZE/ DESCRIPTION	BOX QTY.	VOL. QTY.
----------	----------	------------------------	----------	-----------

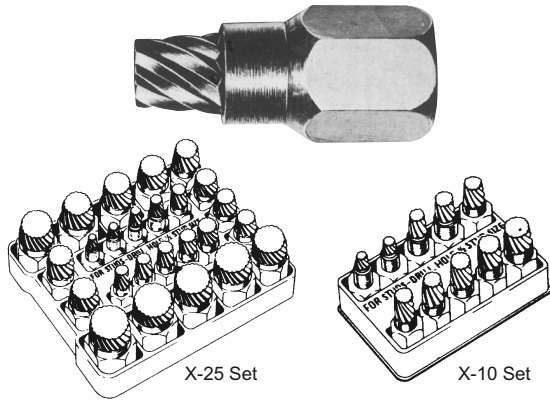

WEDGE-PRUF EXTRACTORS

Extractors remove broken parts without breaking or jamming. Can be used with an impact wrench.

R126700	X-25	All purpose set of 25 tools, sizes 1/8" thru 7/8" in handy box.	1	4
R126800	X-15	Mechanics' set of 15 tools, 7/16" thru 7/8" in handy box.	1	4
R126900	X-10	Handy set of 10, sizes 1/8" thru 13/32" in compact box.	1	4
R127000	X-5	Plumbers' kit pipe sizes 1/8", 1/4", 3/8", 1/2", 5/8" & 3/4"	1	4

CAT. NO.	MFG. NO.	PIPE SIZE	LETTER MARK	TO FIT HOLE SIZE	BOX QTY.	VOL. QTY.
----------	----------	-----------	-------------	------------------	----------	-----------

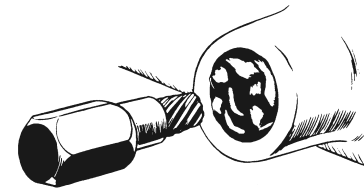

1. INSERT TOOL

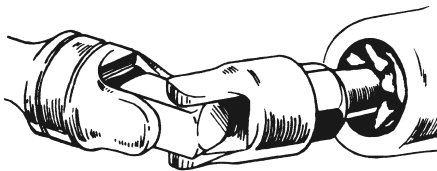

2. TURN

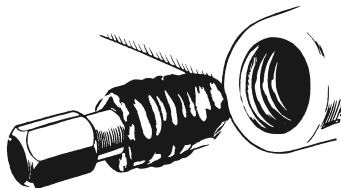

3. OUT IT COMES!

R127100	104	-	A	1/8"	1	6
R127200	105	-	B	5/32"	1	6
R127300	106	-	C	3/16"	1	6
R127400	107	-	D	7/32"	1	6
R127500	108	1/8 IPS	E	1/4"	1	6
R127600	109	-	F	9/32"	1	6
R127700	110	-	G	5/16"	1	6
R127800	111	1/4 IPS	H	11/32"	1	6
R127900	112	-	I	3/8"	1	6
R128000	113	-	J	13/32"	1	6
R128100	114	-	K	7/16"	1	6
R128200	115	3/8 IPS	L	15/32"	1	6
R128300	116	-	M	1/2"	1	6
R128400	117	-	N	17/32"	1	6
R128500	118	-	O	9/16"	1	6
R128600	119	1/2 IPS	P	19/32"	1	6
R128700	120	-	Q	5/8"	1	6
R128800	121	-	R	21/32"	1	6
R128900	122	-	S	11/16"	1	6
R129000	123	-	T	23/32"	1	6
R129100	124	-	U	3/4"	1	6
R129200	125	3/4 IPS	V	25/32"	1	6
R129300	126	-	W	13/16"	1	6
R129400	127	-	X	27/32"	1	6
R129500	128	-	Y	7/8"	1	6

CAT. NO.	PIPE SIZE	LENGTH	BOX QTY.	VOL. QTY.
----------	-----------	--------	----------	-----------

BLADE TYPE INTERNAL PIPE WRENCHES

Screw mandrel to force tough gripping dogs against interior of broken pipe or close nipples, etc. Then turn with wrench.

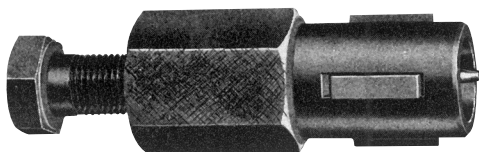

R129600		1/2"	3 1/2"	1	4
R129610	SET OF 3 BLADES	1/2"		1 SET	4 SETS
R129700		3/4"	3 3/4"	1	4
R129710	SET OF 3 BLADES	3/4"		1 SET	4 SETS
R129800		1"	4"	1	4
R129810	SET OF 3 BLADES	1"		1 SET	4 SETS

EXTRACTOR & SPUD WRENCHES

CAT. NO.	MFG. NO.	USE DRILL SIZE	REMOVES BOLTS AND SCREWS	BOX QTY.	VOL. QTY.
----------	----------	----------------	--------------------------	----------	-----------

SPIRAL FLUTE SCREW EXTRACTORS

For removing broken screws and bolts. Correct drill size stamped on each extractor.

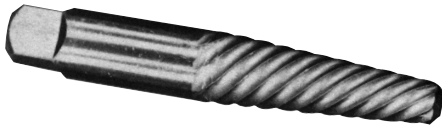

R130000 - R130830

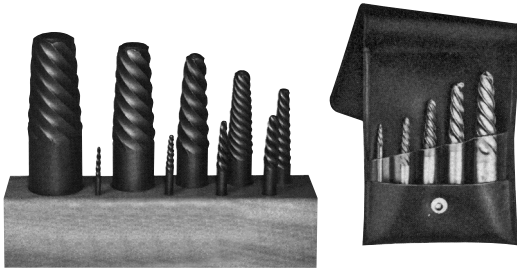

R130000	1	5/64"	3/32" to 5/32"		5	10
R130100	2	7/64"	5/32" to 7/32"		5	10
R130200	3	5/32"	7/32" to 9/32"		5	10
R130300	4	1/4"	9/32" to 3/8"	& 1/8" pipe	5	10
R130400	5	19/64"	3/8" to 5/8"	& 1/4" pipe	5	10
R130500	6	13/32"	5/8" to 7/8"	& 3/8" pipe	1	3
R130600	7	17/32"	7/8" to 1 1/8"	& 1/2" pipe	1	3
R130700	8	13/16"	1 1/8" to 1 3/8"	& 3/4" pipe	1	3
R130800	9	1 1/16"	1 3/8" to 2"	& 1" pipe	1	3
R130810	10		2 1/8" to 2 1/2"	& 1 1/4" pipe	1	3
R130820	11		2 1/2" to 3"	& 1 1/2" pipe	1	3
R130830	12		3" to 3 1/2"	& 2" pipe	1	3

SCREW EXTRACTOR SETS IN PLASTIC POUCHES

R131000	Contains No. 1-2-3-4-5	1	6
R131100	Contains No. 1-2-3-4-5-6	1	6
R131110	Contains No. 1-2-3-4-5-6-7-8-9 in wood stand	1	2

CAT. NO.	MFG. NO.	CAP. USS SCREW	CAP. PIPE	BOX QTY.	VOL. QTY.
----------	----------	----------------	-----------	----------	-----------

SCREW EXTRACTORS

Works on either right or left threads. Drill size clearly marked on each tool.

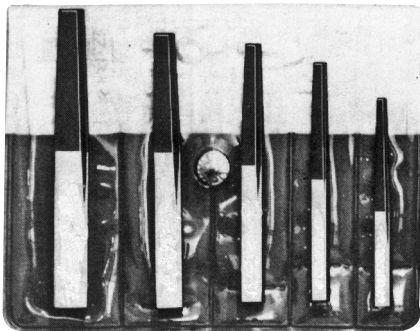
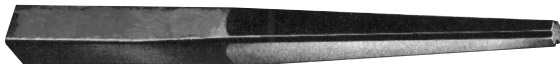

R132200

R131200	9521 (91)	1/4" - 5/16"	-	1	10*
R131300	9522 (92)	3/8"	-	1	10*
R131400	9523 (93)	7/16"	1/8"	1	10*
R131500	9524 (94)	1/2" - 9/16"	1/4"	1	10*
R131600	9525 (95)	5/8"	3/8"	1	10*
R131700	9525 B (96)	3/4"	-	1	10*
R131800	9526 (97)	7/8"	1/2"	1	10*
R131900	9527 (98)	1", 1 1/8"	1/2"	1	10*
R132000	9528 (99)	1 1/4", 1 3/8"	3/4"	1	10*
R132100	9529	1 1/2"	1"	1	10*

*May Be Assorted For Volume Quantity.

SET

R132200 9500-A (90) 1 3
Includes one each Nos. 9521, 9522, 9523, 9524, 9525, and vinyl case.

SET

R132250 9500-B 1 2
Includes one each Nos. 9521, 9522, 9523, 9524, 9525, 9525 B, 9526, 9527, 9528 and 9529.

GASKET SCRAPER

CAT. NO.	MFG. NO.	BLADE WIDTH	LENGTH	BOX QTY.	VOL. QTY.
----------	----------	-------------	--------	----------	-----------

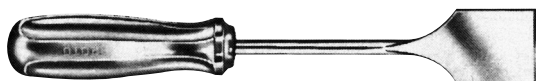

GASKET SCRAPER

Has U. L. approved handle of tough, fire-resistant plastic and forged blade of special alloy steel.

R132500	2336	1 1/2"	11 1/4" Chrome	(1)6	12
R132550	516-W	1 1/2"	11" Black	1	12

RICHARD SPECIALTY CO., INC.

BARS, CHISELS & NAIL PULLERS

CAT. NO.	MFG. NO.	HEX STOCK NO.	LENGTH	BOX QTY.	VOL. QTY.
----------	----------	---------------	--------	----------	-----------

ALIGNING PRY BARS

Hot formed from special alloy steel heat treated for the proper combination of toughness, hardness and strength.



R132600	2116	1/2"	16"	1	3
R132700	2120	5/8"	18"	1	3
R132800	2124	3/4"	24"	1	3
R132900	2125	7/8"	29 3/4"	1	3

ROLLING HEAD BARS

A pry and aligning bar with a long, pointed taper and 90° rolling head. Hot formed from alloy steel and heat treated for extra strength.



R133000	2126	1/2"	16"	1	3
R133100	2130	5/8"	18"	1	3

WRECKING BARS

Pry end has fully polished long chisel point. Nail puller has deep bevel nail claw. Rust-resistant black oxide finish.



R133200	355	5/8"	18"	1	3
R133300	356	3/4"	24"	1	3
R133400	357	3/4"	30"	1	3
R133410	358	3/4"	36"	1	3

NAIL PULLER ("Cats Paw")

A rugged puller for the toughest nail pulling jobs.



R133500	387	5/8"	12"	1	3
---------	-----	------	-----	---	---

SUPERBAR (With Rocker Head)

R133800	B215	-	15"	(1)4	4
---------	------	---	-----	------	---

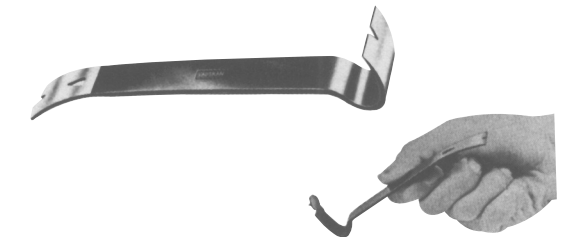

MINI-BAR

R133900	222	-	5 1/2"	(1)10	10
---------	-----	---	--------	-------	----







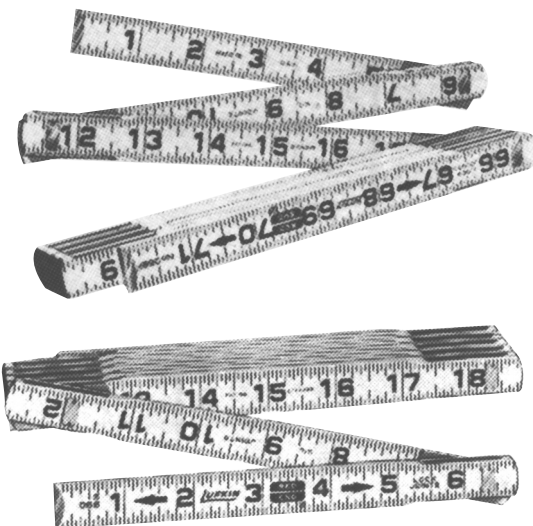



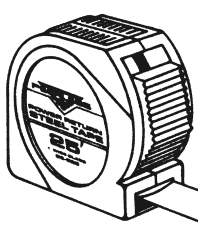
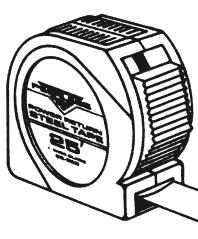

Lufkin®

FOLDING RULERS



CAT. NO.	MFG. NO.	DESCRIPTION	SIZE	BOX QTY.	VOL. QTY.
----------	----------	-------------	------	----------	-----------

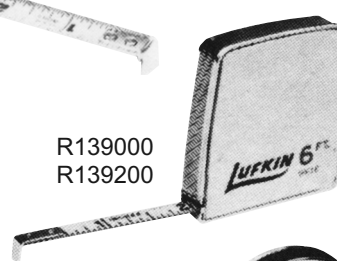

R134600	066FN	Red end folding inside	6'	6	12
R134900	966N	Red end two way inside	6'	6	12
R135300	X46N	Red end extension	6'	6	12
R135400	X46FN	Red end extension inside	6'	6	12
R135500	X46X	Red end extension both sides	6'	6	12
R135600	HX46	Red end extension with hook	6'	6	12
R135700	X48N	Red end extension	8'	6	12
R135800	1066DN	Red end engineers	6'	6	12
R135900	626LN	Red end plumbers with 45°	6'	6	12

TAPE RULES		CAT. NO.	MFG. NO.	DESCRIPTION	SIZE	BOX QTY.	VOL. QTY.
		R138000	P2210	Yellow Mezurlok	1/2" X 10'	(1)6	6
		R138100	P2212	Yellow Mezurlok	1/2" X 12'	(1)6	6
		R138200	P2312	Yellow Mezurlok	3/4" X 12'	(1)6	6
		R138300	P2316	Yellow Mezurlok	3/4" X 16'	(1)6	6
		R138400	2325	Yellow Mezurlok	3/4" X 25'	(1)6	6
R138000 - R138610							
		R138600	L-625	Yellow Mezurlok	1" X 25'	(1)6	6
		R138610	P2410CME	Yellow Mezurlok	1" X 33'	(1)6	6
R138620 - R138640							
		R138620	PHV-1312	Blaze Orange	3/4" X 12'	(1)6	6
		R138625	PHV-1316	Blaze Orange	3/4" X 16'	(1)6	6
		R138635	HV-116	Blaze Orange	1" X 16'	(1)6	6
		R138640	PHV-1425	Blaze Orange	1" X 25'	(1)6	6
R138655							
		R138655	PQR-1425	Quikread	1" X 25'	(1)6	6
R138660 R138665							
		R138660	626-E	Imported	1" X 25'	12	24
		R138665	-	Imported	1" X 33'	(1)6	6
R138700 R138710							
		R138700	-	Magnetic End	1" X 25'	1	6
		R138705 "Jet Swet"		Selflock Magnetic End	1" X 25'	1	12
		R138710	-	Magnetic End	1" X 30'	1	6
R138705							
		R138720	-	Selflock	1" X 25'	1	6
R138720							
		R138800	Y8210	Yellow	1/2" X 10'	(1)6	6
		R138900	Y8212	Yellow	1/2" X 12'	(1)6	6
R138800 R138900							
		R139000	W616	Pee-Wee	1/4" X 6'	(1)6	6
		R139200	W6110	Pee-Wee	1/4" X 10'	(1)6	6
R139000 R139200							
		R139900	W606PD	Meas. dia. of pipe	1/4" X 6'	6	12
R139900							

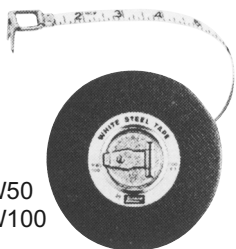
RICHARD SPECIALTY CO., INC.





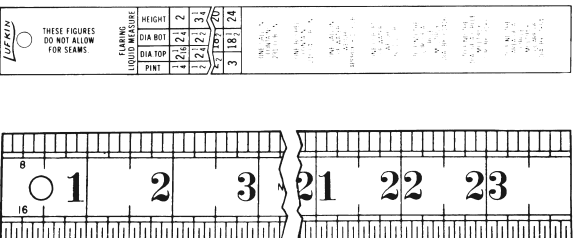







TAPE RULES		CAT. NO.	MFG. NO.	DESCRIPTION	SIZE	BOX QTY.	VOL. QTY.
		R141800	50	Yellow	3/8" X 50'	(1)6	6
		R141900	100L	Yellow	3/8" X 100'	(1)6	6
		R142000	HW50	Yellow	3/8" X 50'	(1)6	6
		R142100	HW100	Yellow	3/8" X 100'	(1)6	6
		R142200	OY50	HW50 Refill	3/8" X 50'	1	6
		R142300	OY100	HW100 Refill	3/8" X 100'	1	6
		R142700	HW223	Yellow	3/8" X 50'	(1)6	6
		R142800	HW226	Yellow	3/8" X 100'	(1)6	6
		R143400	HYT100	Speedwinder	3/8" X 100'	(1)6	6
		R143500	703D	Woven Fiberglass	1/2" X 50'	1	3
		R143600	706L	Woven Fiberglass	1/2" X 100'	1	3

Lufkin

STEEL RULES	CAT. NO.	MFG. NO.	LENGTH	BOX QTY.	VOL. QTY.
		R143900	95-3	3'	1 3
		R144000	95-4	4'	1 3
		R144100	62-1 FT.	12"	1 3
		R144200	62-2 FT.	24"	1 3
		R144300	62-3 FT.	36"	1 3
		R144400	62-4 FT.	48"	1 3
		R144500	62-6 FT.	72"	1 3

IRWIN TOOLS

TINNERS' SNIPS	CAT. NO.	MFG. NO.	DESCRIPTION	LENGTH	CUT	BOX QTY.	VOL. QTY.
			PROSNIP®				
		R144800	20-SL	Cuts straight & left	9"	-	(1)5 5
	R144900	20-SR	Cuts straight & right	9"	-	(1)5 5	

TINNERS' SNIPS		CAT. NO.	MFG. NO.	DESCRIPTION	LENGTH	CUT	BOX QTY.	VOL. QTY.
R145000		R145000	M-1R	Metalmaster Cuts to the left. Red Grips.	9 3/4"	1 3/8"	(1)6	6
R145100		R145100	M-1R-S1	Metalmaster Cuts to the left. Blue Grips. For stainless steel.	9 3/4"	1 3/8"	(1)6	3
R145200		R145200	M-2R	Metalmaster Cuts to the right. Green Grips.	9 3/4"	1 3/8"	(1)6	6
R145300		R145300	M-2R-S1	Metalmaster Cuts to the left. Blue Grips. For stainless steel.	9 3/4"	1 3/8"	(1)6	3
R145400		R145400	M-3R	Metalmaster Cuts straight or curves. Yellow Grips.	9 3/4"	1 1/2"	(1)6	6
R145450		R145450	M-300	Metalmaster Cuts straight.	10 1/2"	3"	(1)6	6
R145500		R145500	M-4R	Pipe & duct snips	8 1/2"	9/16"	(1)6	6
R145600		R145600	M-5R	For notching & shallow arcs.	9 1/4"	7/8"	(1)6	6
R145700 - R145900		R145700	V-10	Solid steel-comb. pattern	10"	2 1/4"	1	6
		R145800	V-13	Solid steel-comb. pattern	7"	1 3/4"	1	6
		R145900	V-19	Solid steel-comb. pattern	13"	3"	1	6
R146000 - R146400		R146000	A-9	Solid Steel-Reg. Pattern	12-1/2"	3"	1	6
		R146100	A-10	Solid Steel-Reg. Pattern	11"	2 1/2"	1	6
		R146200	A-11	Solid Steel-Reg. Pattern	10"	2 1/4"	1	6
		R146300	A-12	Solid Steel-Reg. Pattern	8"	2"	1	6
		R146400	A-13	Solid Steel-Reg. Pattern	7"	1 3/4"	1	6
R146500 - R146800		R146500	W-7	Inlaid Blades-Reg. Pattern	14-1/2"	4"	1	6
		R146510	W-7B	Inlaid Blades-Offset Pattern	14-1/2"	4"	1	6
		R146600	W-8	Inlaid Blades-Reg. Pattern	13-1/2"	3 1/2"	1	6
		R146800	W-10	Inlaid Blades-Reg. Pattern	11-1/2"	2 1/2"	1	6
R146900		R146900	W-5	Bulldog H/Duty Pattern	16-1/2"	2 1/2"	1	6
R147100		R147100	J-7S	Light Metal Snips- Straight Blades.	7"	1 1/4"	(1)6	6
R147200		R147200	P-406	Springs for M-1R, M-3R, M-5R			10	-
R147300		R147300	P-407	Springs for M-2R			10	-

TINNERS' SNIPS

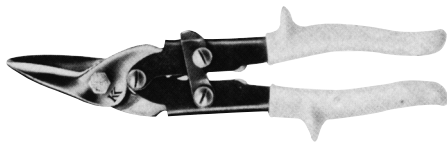

KLENK SNIPS – THE ORIGINAL “AVIATION” SNIP

CAT. NO.	MFG. NO.	DESCRIPTION	CUT	BOX QTY.	VOL. QTY.
R147400	KJ-1RG	Cuts to the left		1	3
R147500	KJ-2LG	Cuts to the right		1	3
R147600	KJ-3G	Straight cut		1	3

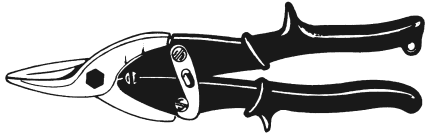

SNIPS – IMPORT-QUALITY

R147620	92519	Snip-Left Cut		1	6
R147625	92520	Snip-Straight Cut		1	6
R147630	92521	Snip-Right Cut		1	6

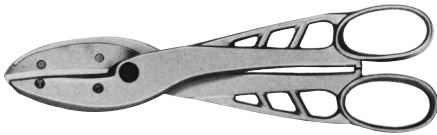

ALUMINUM HANDLE SNIPS

R147700		12" Aluminum Snip	3"	1	-
R147710		Replacement Blade Kit		1	-
R147715		14" Aluminum Snip	3 1/2"	1	-
R147720		Replacement Blade Kit		1	-

LEVELS



CAT. NO.	MFG. NO.	DESCRIPTION	LENGTH	BOX QTY.	VOL. QTY.
----------	----------	-------------	--------	----------	-----------



R147800	580-18VP	Aluminum	18"	1	4
R147900	580-24	Aluminum	24"	1	4
R148000	EN81-12	Aluminum-Magnetic	12"	1	3
R148100	581-18	Aluminum-Magnetic	18"	1	3
R148200	581-24	Aluminum-Magnetic	24"	1	3
R148220	581-48	Aluminum-Magnetic	48"	1	2
R148300	430-18	Aluminum	18"	1	4
R148400	E80-24	Aluminum	24"	1	4
R148500	E80-48	Aluminum	48"	1	2



R148600	ML-18	Alum. w/Pitch Indicator	18"	1	4
R148700	ML-24	Alum. w/Pitch Indicator	24"	1	4



R148800		Wood-Plain	18"	1	6
R148900		Wood-Plain	24"	1	6
R149000		Wood-Plain	48"	1	2



R149400	E80-9	Aluminum Torpedo	9"	(1)10	10
R149500	EM81-9	Aluminum Torpedo Magnetic	9"	(1)10	10
R149550	33-9	Polycast Torpedo	9"	(1)10	10
R149600	331-9	Aluminum Torpedo Magnetic	9"	(1)10	10
R149620	581-9	Aluminum Torpedo Magnetic	9"	(1)10	10







R149650	A-9-R	Torpedo Level	9"	(1)6	6
R149700	EM95.10	LED Lighted Torpedo Level	9"	1	3
R149710	EM95.24	LED Lighted Torpedo Level	24"	1	3
R149720	EM95.48	LED Lighted Torpedo Level	48"	1	3

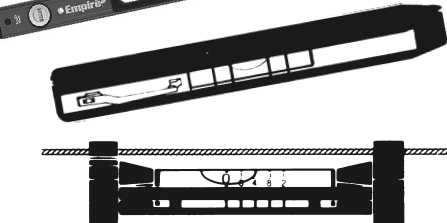

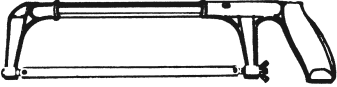
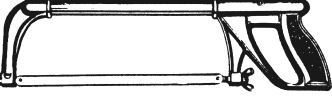

R149800	84-5	Pocket Level	5"	(1)10	10
---------	------	--------------	----	-------	----

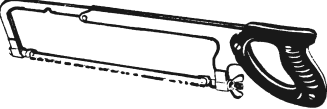

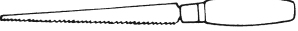



R149900	83-3	Line Level	3"	(1)10	10
---------	------	------------	----	-------	----

HACKSAW FRAMES		CAT. NO.	MFG. NO.	DESCRIPTION	BLADE	BOX QTY.	VOL. QTY.
	R150200	EH-70	Corvette	10" or 12"	1	3	
	R150400	EH-60	Tubular	10" or 12"	1	3	
	R150500	EH-50	Challenger has tension wheel	12"	1	3	
	R150550	K-153	Super Heavy Duty Hack saw	12"	1	3	
	R150600	125	Adjustable up to 12"	10" or 12"	1	3	
	R150700	MS-65	Mini -Saw	10" or 12"	(1)6	6	
	R150800	3C	Handisaw	6"	1	6	

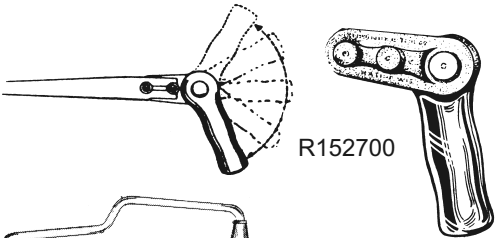
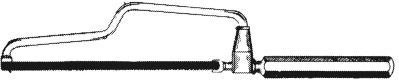
HACKSAW BLADES		CAT. NO.	LENGTH	TEETH	WIDTH	THICK	BOX QTY.	VOL. QTY.
STANDARD STEEL (With Hard Edge)								
	R151100	10"	18	1/2"	.025"	10	50	
	R151200	10"	24	1/2"	.025"	10	50	
	R151300	10"	32	1/2"	.025"	10	50	
	R151400	12"	18	1/2"	.025"	10	50	
	R151500	12"	24	1/2"	.025"	10	50	
	R151600	12"	32	1/2"	.025"	10	50	
HIGH SPEED STEEL HACKSAW BLADES (Moly)								
	R151700	10"	18	1/2"	.025"	10	50	
	R151800	10"	24	1/2"	.025"	10	50	
	R151900	10"	32	1/2"	.025"	10	50	
	R152000	12"	18	1/2"	.025"	10	50	
	R152100	12"	24	1/2"	.025"	10	50	
	R152200	12"	32	1/2"	.025"	10	50	
BI-METAL (Highest Quality)								
	R152310	12"	18	1/2"	-	10	30	
	R152320	12"	24	1/2"	-	10	30	
	R152330	12"	32	1/2"	-	10	30	

RICHARD SPECIALTY CO., INC.

COMPASS SAW HANDLES		CAT. NO.	DESCRIPTION	BOX QTY.	VOL. QTY.
	R152700	DO-MOR Handle.	1	6	
	R152800	Baby Hacksaw Frames - Pin Type.	1	12	
	R152900	Baby Hacksaw Blades.	10	100	
	R153000	Tiny Tim Hacksaw Frames - Pin Type.	1	12	
	R153100	Tiny Tim Hacksaw Blades.	10	100	

COMPASS SAW BLADES		CAT. NO.	MFG. NO.	LENGTH	BOX QTY.	VOL. QTY.
For cutting through wood and plaster. The fine teeth of these blades will cut through nails without difficulty.						
	R153500	10	12"	10	20	
	R153600	12	14"	10	20	

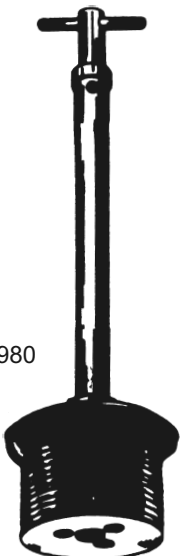

FLOOR DRAIN STOPPERS & TEST PLUGS		CAT. NO.	MFG. NO.	SIZE	BOX QTY.	VOL. QTY.
Twis-Tite® Floor Drain Stopper & Test Plug						
	R153860	10500 - 1	1/2"	1	50*	
	R153865	10500 - 2	5/8"	1	50*	
	R153870	10500 - 3	3/4"	1	50*	
	R153875	10500 - 4	7/8"	1	50*	
	R153900	10501	1"	1	50*	
	R153905	10501 - 1	1 1/4"	1	50*	
	R153910	10501 - 2	1 1/2"	1	50*	
	R153915	10501 - 3	1 3/4"	1	50*	
	R153920	10502	2"	1	50*	
	R153925	10502 - 2	2 1/4"	1	50*	
	R153930	10502 - 3	2 1/2"	1	50*	
	R153935	10502 - 4	2 3/4"	1	50*	
	R153940	10503	3"	1	50*	
	R153945	10503 - 2	3 1/4"	1	50*	
	R153950	10503 - 3	3 1/2"	1	50*	
	R153955	10503 - 4	3 3/4"	1	50*	
R153960	10504	4"	1	50*		
	R153962	10504-2	4 1/4"	1	50*	
	R153964	10504-3	4 1/2"	1	50*	
	R153966	10504-4	4 3/4"	1	50*	
	R153968	10505	5"	1	50*	
		R153980	10604	4"	1	50*
Twis-Tite® Floor Drain Stopper With 30" Standpipe						

*All Twis-Tites Can Be Assorted For Volume Quantity.

TEST PLUGS



SINGLE TEST PLUGS - RIBBED

R154000	1 1/2" IPS	1	6
R154100	2" IPS	1	6
R154200	3" IPS	1	6
R154300	4" IPS	1	6
R154400	5" IPS	1	6
R154500	6" IPS	1	6
R154600	8" IPS	1	6

(Replacement Rubbers Available All Sizes.)

(Prices Quoted On Application.)

SINGLE FLEXIBLE TEST PLUG

Wherever the job is rough the single flexible test plug can be used from a length of 24" to 8'. Specify size and length.

3", 4", 5", 6" & 8" Sizes Available
 24" - 30" - 36" - 48" Lengths
 60" - 72" - 80" - 96" Available

Prices Quoted On Application.

CAT. NO.	FITS INSIDE PIPE DIA.	UNEXPANDED	BOX QTY.	VOL. QTY.
R154900	1/2" IPS	15/32"	1	6
R154910	3/4" IPS	23/32"	1	6
R154920	1" IPS	31/32"	1	6
R154930	1 1/4" IPS	1 1/8"	1	6
R155000	1 1/2" IPS	1 3/8"	1	6
R155100	2" IPS	1 3/4"	1	6
R155150	2 1/2" IPS	2 3/8"	1	6
R155200	3" IPS	2 3/4"	1	6
R155250	3 1/2" IPS	3 3/8"	1	6
R155300	4" IPS	3 5/8"	1	6
R155400	5" IPS	4 1/2"	1	6
R155500	6" IPS	5 1/2"	1	6
R155550	7" IPS	6 5/8"	1	6
R155600	8" IPS	7 1/2"	1	6
R155700	10" IPS	9 1/2"	1	2
R155800	12" IPS	11 1/2"	1	2
R155830	14" IPS	13 5/8"	1	2
R155900	15" IPS	14 5/8"	1	2
R156000	16" IPS	15 5/8"	1	2
R156050	17" IPS	16 5/8"	1	2
R156100	18" IPS	17 5/8"	1	2
R156150	19" IPS	18 5/8"	1	2
R156200	20" IPS	19 5/8"	1	2
R156220	21" IPS	20 5/8"	1	2
R156240	22" IPS	21 5/8"	1	2
R156300	24" IPS	23 5/8"	1	2
R156310	30" IPS	29 5/8"	1	2

Replacement Rubber Available All Sizes, Call For Pricing.

RICHARD SPECIALTY CO., INC.

TEST PLUGS

CAT. NO.	SIZE	DESCRIPTION	BOX QTY.	VOL. QTY.
----------	------	-------------	----------	-----------

STRAIGHT DOUBLE TEST PLUGS

R156400	2"	2" IPS	1	2
R156405	3"	3" IPS	1	2
R156410	4"	4" IPS	1	2
R156415	6"	6" IPS	1	2

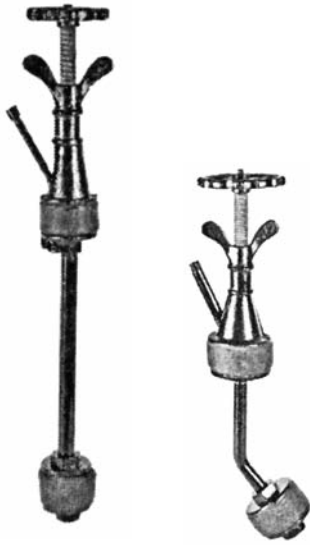

Y BRANCH DOUBLE TEST PLUGS

R156500	2"	2" IPS	1	2
R156505	3"	3" IPS	1	2
R156510	4"	4" IPS	1	2
R156515	5"	5" IPS	1	2
R156520	6"	6" IPS	1	2



FLEXIBLE DOUBLE TEST PLUGS

R156900	1 1/2"	1 1/2" IPS	1	4
R157000	2"	2" IPS	1	4
R157100	3"	3" IPS	1	4
R157200	4" 12" C-C	4" IPS	1	4
R157300	4" 16" C-C	4" IPS	1	4
R157400	5"	5" IPS	1	2
R157500	6"	6" IPS	1	2
R157600	8"	8" IPS	1	2

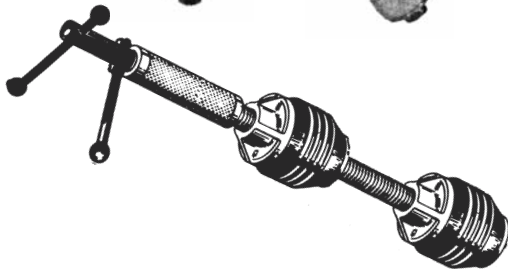

DYNAMYTER TEST PLUG - Ribbed

R158000	1 1/2"	1 1/2" IPS-ABS-DWV	1	24*
R158100	2"	2" IPS-ABS-DWV	1	24*
R158200	3"	3" IPS-ABS-DWV	1	24*
R158250	3 1/2"	3 1/2" IPS-ABS-DWV	1	24*
R158300	4"	4" IPS-ABS-DWV	1	24*
R158400	5"	5" IPS-ABS-DWV	1	24*
R158500	6"	6" IPS-ABS-DWV	1	24*



*May Be Assorted For Volume Quantity.

MARQ 2 TEST PLUGS - RIBBED

Steel plates with metal washer to turn easily.

R158800	1"	1" IPS-ABS-DWV	1	36
R158900	1 1/4"	1 1/4" IPS-ABS-DWV	1	36
R159000	1 1/2"	1 1/2" IPS-ABS-DWV	1	36
R159100	2"	2" IPS-ABS-DWV	1	36
R159200	3"	3" IPS-ABS-DWV	1	36
R159300	4"	4" IPS-ABS-DWV	1	36



ECONO TEST PLUG - PLAIN

R159320	1"	1" IPS-ABS-DWV	1	36
R159325	1 1/4"	1 1/4" IPS-ABS-DWV	1	36
R159330	1 1/2"	1 1/2" IPS-ABS-DWV	1	36
R159335	2"	2" IPS-ABS-DWV	1	36
R159340	3"	3" IPS-ABS-DWV	1	36
R159345	4"	4" IPS-ABS-DWV	1	36



3" & 4" Have Extra Large Wingnut.

TEST PLUGS

CAT. NO.	MFG. NO.	SIZE	DESCRIPTION	BOX QTY.	VOL. QTY.
----------	----------	------	-------------	----------	-----------

ECONO - EXTRA HEAVY PLASTIC - RIBBED

R159360		1 1/2"	1 1/2" IPS	1	6
R159362		2"	2" IPS	1	6
R159364		3"	3" IPS	1	6
R159368		4"	4" IPS	1	6
R159372		6"	6" IPS	1	6
R159374		8"	8" IPS	1	6

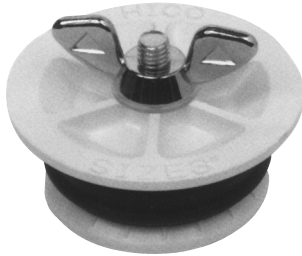

PLASTIC WINGNUT TEST PLUGS

Made of engineering plastics and rubber corrosion-resistant and lightweight.

R159400		1 1/2"		1	6
R159410		2"		1	6
R159415		3"		1	6
R159420		4"		1	6
R159425		5"		1	6
R159430		6"		1	6

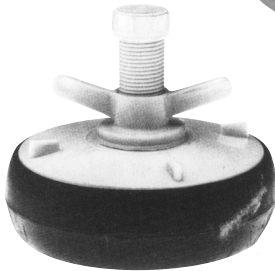

TEST PLUGS - SINGLE - INFLATABLE

R159510	030-1.5-1	1 1/4"-1 1/2"		1	6
R159515	030-02-1	2"		1	6
R159520	030-03-1	3"		1	6
R159525	030-04-1	4"		1	6
R159530	030-05-1	5"		1	2
R159535	030-06-1	6"		1	2
R159540	030-08-1	8"		1	2
R159545	030-10-1	10"		1	2
R159550	030-12-1	12"		1	2

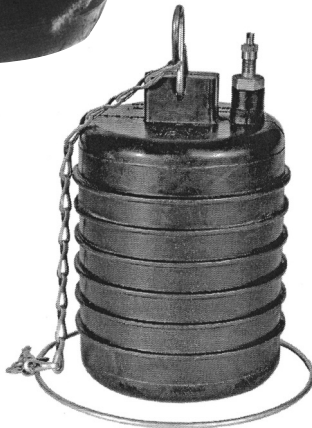

T-CONE TEST PLUG

Combination cleanout and test plug. 1 1/2" - 8" tests up to 3 stories of head pressure. Fits schedule 40 DWV pipe.

R159570		1 1/2"		1	50
R159572		2"		1	50
R159574		3"		1	50
R159575		3 1/2"		1	50
R159575DT		3 1/2"	T-cone (for Drum Tap)	1	50
R159576		4"		1	50
R159577		5"		1	50
R159578		6"		1	50
R159580		8"		1	50

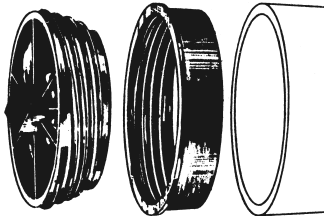

TEST PLUGS - DOUBLE - INFLATABLE

R159602	031-02-1	2"		1	2
R159604	031-03-1	3"		1	2
R159606	031-04-1	4"		1	2
R159610	031-46-1	4"-6"		1	2
R159612	031-68-1	6"-8"		1	2

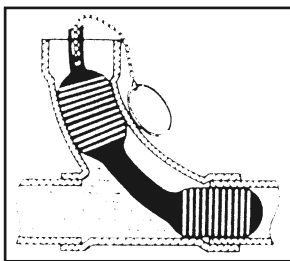

EXTENSION HOSE

R159710	330-02-7		2' Extension Hose	1	6
R159720	330-03-7		3' Extension Hose	1	6
R159730	330-05-7		5' Extension Hose	1	3
R159740	330-10-7		10' Extension Hose	1	3
R159750	330-20-7		20' Extension Hose	1	3



Larger Hoses Available. Price on Application.

RICHARD SPECIALTY CO., INC.

TEST PLUGS

CAT. NO.	MFG. NO.	SIZE	DESCRIPTION	BOX QTY.	VOL. QTY.
----------	----------	------	-------------	----------	-----------

COPPER TEST PLUGS - IMPERIAL

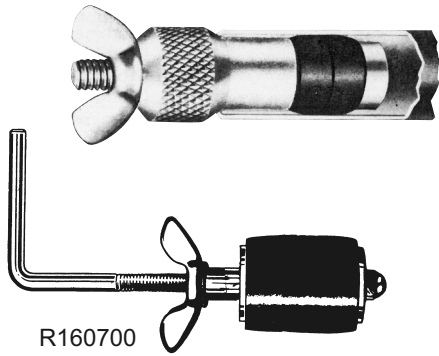

R159800	140-F-04		1/4" O.D. Nom. size 1/8"	1	6
R159900	140-F-06		3/8" O.D. Nom. size 1/4"	1	6
R160000	140-F-08		1/2" O.D. Nom. size 3/8"	1	6
R160100	140-F-10		5/8" O.D. Nom. size 1/2"	1	6
R160200	140-F-12		3/4" O.D. Nom. size 5/8"	1	6
R160300	140-F-14		7/8" O.D. Nom. size 3/4"	1	6
R160400	140-F-18		1 1/8" O.D. Nom. size 1"	1	6
R160500	140-F-22		1 3/8" O.D. Nom. size 1 1/4"	1	6
R160600	140-F-26		1 5/8" O.D. Nom. size 1 1/2"	1	6
R160700			1 1/2" - 2" Two sizes in one	1	6

COPPER TEST PLUGS

Designed for temporarily sealing off copper tubings in plumbing, heating, refrigerating and instrumentation applications.

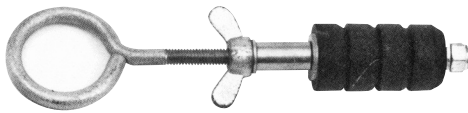

STEM CONNECTION

R160810		1/2"	None	1	6
R160815		3/4"	None	1	6
R160820		1"	None	1	6
R160825		1 1/4"	None	1	6
R160845		3"	None	1	6

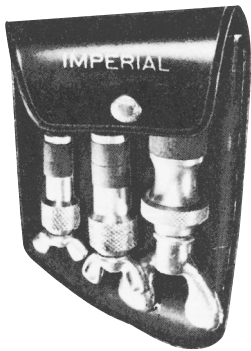

TEST PLUG KIT - IMPERIAL

Plastic case with three most popular plug sizes.

R161000	142-F		1/2", 5/8" & 7/8" O.D. Nom. size 3/8", 1/2" & 3/4"	1	6
---------	-------	--	---	---	---



PLASTIC KNOCK OUT PLUGS

R161210		1 1/2"		100	500*
R161215		2"		100	500*
R161220		3"		100	500*
R161225		4"		100	500*

*May Be Assorted For Volume Quantity.

TEST CAPS

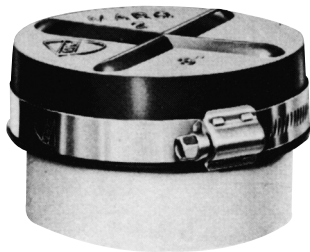

Easy to install with nutdriver, screwdriver or "NO-HUB" wrench.

R161400		1 1/2"	1 1/2" IPS-ABS-DWV	1	36*
R161500		2"	2" IPS-ABS-DWV	1	36*
R161600		3"	3" IPS-ABS-DWV	1	36*
R161700		4"	4" IPS-ABS-DWV	1	36*
R161800		5"	5" IPS-ABS-DWV	1	36*
R161900		6"	6" IPS-ABS-DWV	1	36*
R161910		8"	8" IPS-ABS-DWV	1	36*

*May Be Assorted For Volume Quantity.

"NO-HUB" TORQUE WRENCH

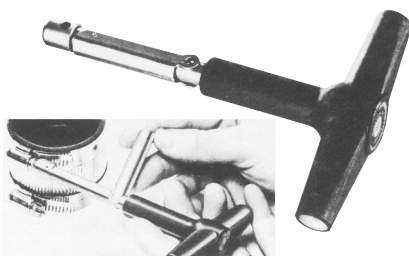

Automatic releases at pre-set 60 in. lb. No dials to read- "torque by feel". Ratches one way. Built in reversing lever.

R162000	60NH	5/16"	Over-all length 6"	1	6
R162300		5/16"	Imported 6"	1	6

FITTING AND TUBING BRUSHES

CAT. NO.

SIZE

BOX VOL. QTY. QTY.

ECONOMY BRUSHES



R162400	1/8" I.D.(Nominal)	12	72*
R162405	1/4" I.D.(Nominal)	12	72*
R162410	3/8" I.D.(Nominal)	12	72*
R162415	1/2" I.D.(Nominal)	12	72*
R162420	3/4" I.D.(Nominal)	12	72*
R162425	1" I.D.(Nominal)	12	72*
R162430	1 1/4" I.D.(Nominal)	6	72*
R162435	1 1/2" I.D.(Nominal)	6	72*
R162440	2" I.D.(Nominal)	6	72*
R162445**	2 1/2" I.D.(Nominal)	6	72*
R162450**	3" I.D.(Nominal)	6	72*

*May Be Assorted For Volume Quantity.

** T-Handle

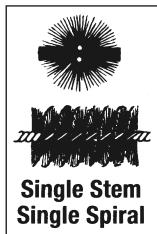
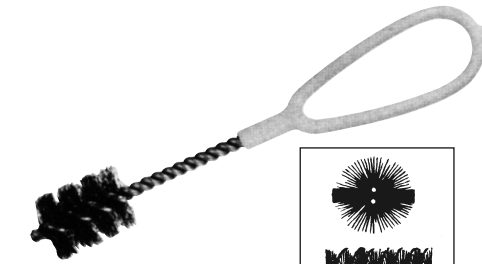

SOFT GRIP BRUSH - STAINLESS STEEL BRISTLES

R162500	1/4" I.D.(Nominal)	12	72*
R162505	3/8" I.D.(Nominal)	12	72*
R162510	1/2" I.D.(Nominal)	12	72*
R162515	5/8" I.D.(Nominal)	12	72*
R162520	3/4" I.D.(Nominal)	12	72*
R162525	7/8" I.D.(Nominal)	12	72*
R162530	1" I.D.(Nominal)	12	72*
R162535	1 1/4" I.D.(Nominal)	8	72*
R162540	1 1/2" I.D.(Nominal)	6	72*
R162545	2" I.D.(Nominal)	6	72*

*May Be Assorted For Volume Quantity.

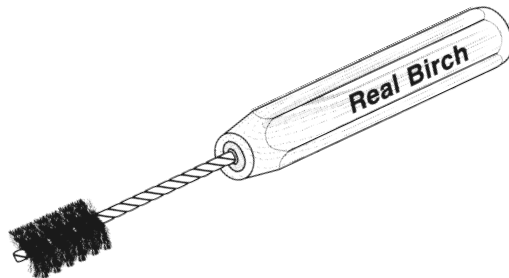

WOOD HANDLE BRUSH - STAINLESS STEEL FILLED

R162550	1/4" I.D.(Nominal)	12	72*
R162555	3/8" I.D.(Nominal)	12	72*
R162560	1/2" I.D.(Nominal)	12	72*
R162565	3/4" I.D.(Nominal)	12	72*
R162570	1" I.D.(Nominal)	12	72*
R162575	1 1/4" I.D.(Nominal)	6	72*
R162580	1 1/2" I.D.(Nominal)	6	72*
R162585	2" I.D.(Nominal)	6	72*

*May Be Assorted For Volume Quantity.



HARD HEAD BRUSH (With Washer End Plate)

R162700	3/8" I.D.(Nominal)	12	72*
R162800	1/2" I.D.(Nominal)	12	72*
R163000	3/4" I.D.(Nominal)	12	72*
R163100	1" I.D.(Nominal)	10	72*
R163200	1 1/4" I.D.(Nominal)	10	72*
R163300	1 1/2" I.D.(Nominal)	6	72*
R163400	2" I.D.(Nominal)	4	72*

*May Be Assorted For Volume Quantity.

QUICK TWIST BRUSHES (Stainless Steel H/Duty Brush)



R163450	Quick Twist	1/8" I.D.(Nominal)	12	144*
R163500	Quick Twist	1/4" I.D.(Nominal)	12	144*
R163600	Quick Twist	3/8" I.D.(Nominal)	12	144*
R163700	Quick Twist	1/2" I.D.(Nominal)	12	144*
R163800	Quick Twist	5/8" I.D.(Nominal)	12	144*
R163900	Quick Twist	3/4" I.D.(Nominal)	12	144*
R164000	Quick Twist	7/8" I.D.(Nominal)	12	144*
R164100	Quick Twist	1" I.D.(Nominal)	12	144*
R164200	Quick Twist	1 1/4" I.D.(Nominal)	8	144*
R164300	Quick Twist	1 1/2" I.D.(Nominal)	6	144*
R164400	Quick Twist	2" I.D.(Nominal)	6	144*
R164450	Quick Twist	2 1/2" I.D.(Nominal)	1	144*
R164500	Quick Twist	3" I.D.(Nominal)	1	144*
R164600	Quick Twist	4" I.D.(Nominal)	1	144*

*May Be Assorted For Volume Quantity.

RICHARD SPECIALTY CO., INC.

FITTING AND TUBING BRUSHES

CAT. NO.	MFG. NO.	SIZE	BOX QTY.	VOL. QTY.
----------	----------	------	----------	-----------

BRUSH WITH HANG UP HOLE



R164610		1/4" I.D.(Nominal)	12	72*
R164615		3/8" I.D.(Nominal)	12	72*
R164620		1/2" I.D.(Nominal)	12	72*
R164630		3/4" I.D.(Nominal)	12	72*
R164640		1" I.D.(Nominal)	12	72*
R164645		1 1/4" I.D.(Nominal)	6	72*
R164650		1 1/2" I.D.(Nominal)	6	72*
R164655		2" I.D.(Nominal)	6	72*

*May Be Assorted For Volume Quantity.

RICHARD SPECIALTY BRUSHES

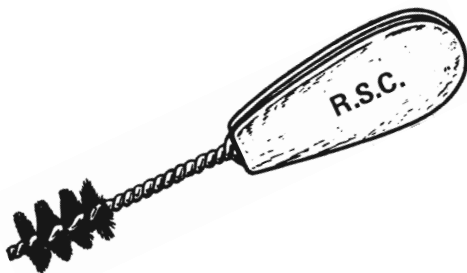

R164700		1/8" I.D.(Nominal)	12	144*
R164800		1/4" I.D.(Nominal)	12	144*
R164900		3/8" I.D.(Nominal)	12	144*
R165000		1/2" I.D.(Nominal)	12	144*
R165100		5/8" I.D.(Nominal)	12	144*
R165200		3/4" I.D.(Nominal)	12	144*
R165300		7/8" I.D.(Nominal)	12	144*
R165400		1" I.D.(Nominal)	12	144*
R165500		1 1/4" I.D.(Nominal)	12	144*
R165600		1 1/2" I.D.(Nominal)	6	144*
R165700		2" I.D.(Nominal)	6	144*

*May Be Assorted For Volume Quantity.

HEAVY DUTY BRUSH - 4 WIRE



R165705		1/8" I.D.(Nominal)	12	72*
R165710		1/4" I.D.(Nominal)	12	72*
R165715		3/8" I.D.(Nominal)	12	72*
R165720		1/2" I.D.(Nominal)	12	72*
R165725		5/8" I.D.(Nominal)	12	72*
R165730		3/4" I.D.(Nominal)	10	72*
R165735		7/8" I.D.(Nominal)	10	72*
R165740		1" I.D.(Nominal)	8	72*
R165745		1 1/4" I.D.(Nominal)	6	72*
R165750		1 1/2" I.D.(Nominal)	6	72*
R165755		2" I.D.(Nominal)	6	72*

*May Be Assorted For Volume Quantity.

OUTSIDE TUBING BRUSHES

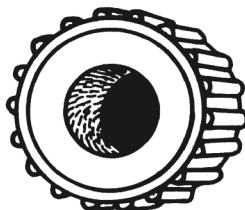
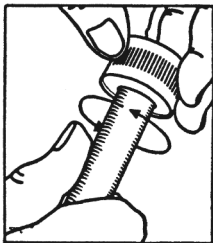

R165800	964-R	1/4" I.D.(Nominal)	6	24*
R165900	965-R	3/8" I.D.(Nominal)	6	24*
R166000	966-R	1/2" I.D.(Nominal)	6	24*
R166100	967-R	5/8" I.D.(Nominal)	6	24*
R166200	968-R	3/4" I.D.(Nominal)	6	24*
R166300	969-R	7/8" I.D.(Nominal)	6	24*
R166400	970-R	1" I.D.(Nominal)	6	24*

*May Be Assorted For Volume Quantity.

FITTING AND TUBING BRUSHES

CAT. NO.

SIZE

BOX VOL. QTY. QTY.

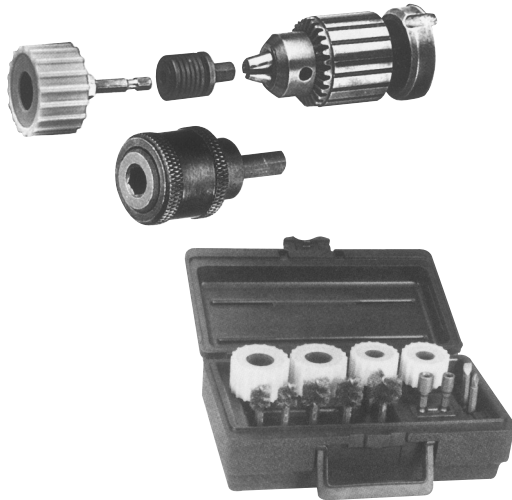

OUTSIDE TUBING BRUSHES - POWER - 1/4" Hex Shank

R166410	965-PR	3/8" I.D.(Nominal)	5	20*
R166415	966-PR	1/2" I.D.(Nominal)	5	20*
R166420	967-PR	5/8" I.D.(Nominal)	5	20*
R166425	968-PR	3/4" I.D.(Nominal)	5	20*
R166430	969-PR	7/8" I.D.(Nominal)	5	20*
R166435	970-PR	1" I.D.(Nominal)	5	20*

*May Be Assorted For Volume Quantity.

POWER BRUSH KIT - INSIDE & OUTSIDE - 1/4" Hex Size

R166438	Power Brush Kit	1	6
R166440	Quick Change Chuck Adapter (Use With Above Brushes)	1	5

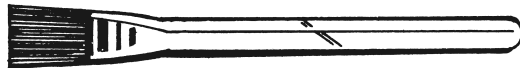

ACID BRUSHES (Overall Length 6")

R166500	1	Bristles 5/16" X 3/4"	(1)144	864*
R166600	2	Bristles 3/8" X 3/4"	(1)144	864*
R166700	3	Bristles 1/2" X 3/4"	(1)144	864*

*May Be Assorted For Volume Quantity.



WOOD HANDLE DOPE BRUSH (Overall Length 7")

Round wood handle with metal ferrule.

R166800	7	Bristles 3/4" wide	(1)144	288
---------	---	--------------------	--------	-----



POWER-DEUCE BRUSH

R166830	1/2"	(1)12	12
R166835	3/4"	(1)12	12
R166840	1"	(1)12	12

POWER-DEUCE - DISPLAY-12 PACK

R166845	1/2"	1	2
R166850	3/4"	1	2
R166855	1"	1	2

POWER-DEUCE KIT

R166860	62850	Consisting of 1 1/2", 3/4" & 1" Power Deuce Brush plus 1/4" quick change adaptor.	1	2
---------	-------	---	---	---



FOUR-IN-ONE TOOL

R166900	4 in 1 Brush for 1/2" & 3/4" inside & outside (Nominal) (Yellow & Black)	(1)12	12
R167000	4 in 1 Refill Kit (for above brush)	(1)6	12
R167002	4 in 1 Brush - Blue	(1)12	12
R167004	4 in 1 Refill Kit - (for Blue)	(1)6	12
R167005	6 in 1 Brush/Deburrer (Uses R167000 Refill Kit)	(1)8	8

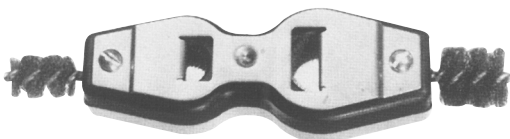

RICHARD SPECIALTY CO., INC.

FITTING AND TUBING BRUSHES

CAT.
NO.

SIZE

BOX VOL.
QTY. QTY.

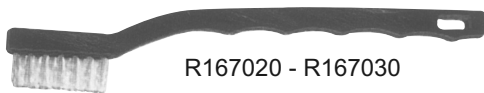

R167020 - R167030

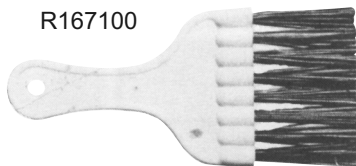

R167100

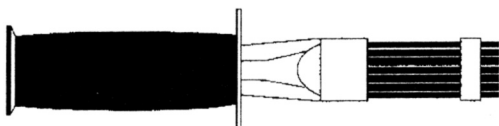

R167110

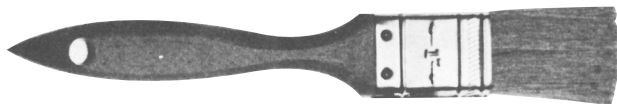

SCRATCH BRUSHES

R167020	Stainless Steel	3 X 7 Plastic Handle	6	36
R167025	Brass	3 X 7 Plastic Handle	6	36
R167030	Nylon	3 X 7 Plastic Handle	6	36
R167035		SET OF ONE OF EACH	1	10

FIN & COIL BRUSH

R167100	Fin & Coil Brush	(1)12	12
R167110	Fin Comb	(1)12	12

SOLVENT BRUSHES

R167150	1/2" Wide	(1)36	72*
R167200	1" Wide	(1)36	72*
R167300	1 1/2" Wide	(1)12	72*
R167400	2" Wide	(1)12	72*
R167410	2 1/2" Wide	(1)12	72*
R167415	3" Wide	(1)12	72*
R167420	4" Wide	(1)12	72*

*May Be Assorted For Volume Quantity.

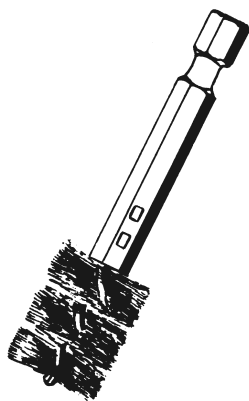

POWER BRUSHES - 1/4" HEX SHANK - 2 PER PK.

(Use With Quick Change Adapter)

R167700	1/4" I.D.	1PK.	5PK.
R167705	3/8" I.D.	1PK.	5PK.
R167710	1/2" I.D.	1PK.	5PK.
R167715	5/8" I.D.	1PK.	5PK.
R167720	3/4" I.D.	1PK.	5PK.
R167725	7/8" I.D.	1PK.	5PK.
R167730	1" I.D.	1PK.	5PK.
R167732	1 1/4" I.D.	1PK.	5PK.
R167734	1 3/8" I.D.	1PK.	5PK.
R167736	1 1/2" I.D.	1PK.	5PK.
R167738	2" I.D.	1PK.	5PK.

Below 1 per package only.

R167740	2 1/2" I.D.	1	5
R167742	3" I.D.	1	5
R167744	4" I.D.	1	5



COTTON SWAB

R167760	Rayon 1 1/2" X 11"	(1)12	12
R167765	Rayon 2" X 11"	(1)12	12
R167770	Cotton 2" X 15"	(1)12	12



WIRE CLEANING BRUSHES (Wood Back)

R167800	Brush Part 6 1/4" Long 14" Overall Wire Extends 1 3/16"	(1)12	12
---------	--	-------	----

FITTING & TUBING BRUSHES

CAT. NO. SINGLE	MFG. NO. SINGLE	CAT. NO. DOUBLE	MFG. NO. DOUBLE	BRUSH DIA.	FLUE DIA.	BOX QTY.	VOL. QTY.
-----------------	-----------------	-----------------	-----------------	------------	-----------	----------	-----------

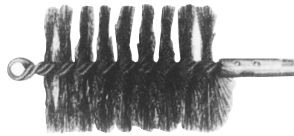

Single Spiral

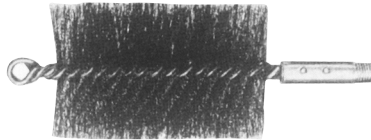

Double Spiral

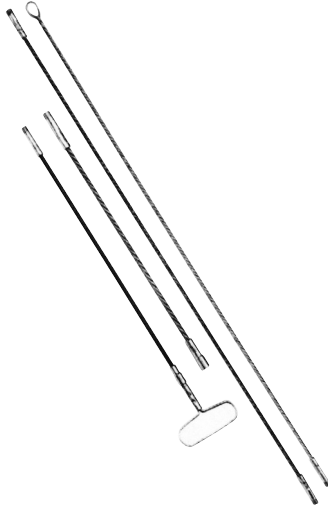

FLUE & BOILER TUBE BRUSHES - 1/4" NPT

R167810	83002	R167830	84002	1/2"	3/4"	1	6*
R167811	83005	R167831	84005	3/4"	1"	1	6*
R167812	83010	R167832	84010	1"	1 1/4"	1	6*
R167813	83015	R167833	84015	1 1/4"	1 1/2"	1	6*
R167814	83020	R167834	84020	1 1/2"	1 3/4"	1	6*
R167815	83025	R167835	84025	1 3/4"	2"	1	6*
R167816	83030	R167836	84030	2"	2 1/4"	1	6*
R167817	83035	R167837	84035	2 1/4"	2 1/2"	1	6*
R167818	83040	R167838	84040	2 1/2"	2 3/4"	1	6*
R167819	83045	R167839	84045	2 3/4"	3"	1	6*
R167820	83050	R167840	84050	3"	3 1/4"	1	6*
R167821	83055	R167841	84055	3 1/4"	3 1/2"	1	6*
R167822	83060	R167842	84060	3 1/2"	3 3/4"	1	6*
R167823	83065	R167843	84065	3 3/4"	4"	1	6*
R167824	83070	R167844	84070	4"	4 1/4"	1	6*
R167825	83085	R167845	84090	5"	5 1/4"	1	6*
R167826	83100	R167846	84105	6"	6 1/4"	1	6*

Extension Rods For Above.

R167850	30002	3' Fiberglass	1	6*
R167851	30021	4' Fiberglass	1	6*
R167853	30061	6' Fiberglass	1	6*
R167854	30007	3' Twisted Steel Rod	1	6*
R167855	30031	4' Twisted Steel Rod	1	6*
R167856	30064	6' Twisted Steel Rod	1	6*
R167857	30003	3' Ext. Handle Twisted Steel Rod	1	6*
R167858	70766	"I" Extention Rod Handle	1	6*

*May Be Assorted For Volume Quantity.

NYLON TUBE BRISTLES

CAT. NO.	MFG. NO.	BRUSH DIA.	FLUE DIA.	BOX QTY.	VOL. QTY.
----------	----------	------------	-----------	----------	-----------



FOR BOILERS, BURNERS, RADIATORS, FLUES, VENTS & NOZZLES

R167860	04882	1/4"	6 1/4"	6	24*
R167861	04883	3/8"	6 1/4"	6	24*
R167862	04884	1/2"	8 1/2"	6	24*
R167863	01445	1/2"	30"	6	24*
R167864	04867	3/4"	9"	6	24*
R167866	01450	3/4"	30"	6	24*
R167867	01470	3/4"	36"	6	24*
R167868	04888	1"	12 1/4"	6	24*
R167869	01455	1"	30"	6	24*
R167870	01475	1"	36"	6	24*
R167871	04890	1 1/4"	13"	6	24*
R167872	04891	1 1/2"	13"	6	24*
R167873	01460	1 1/2"	30"	6	24*
R167874	01478	1 1/2"	36"	6	24*
R167875	04892	2"	16"	6	24*
R167876	01520	2"	24"	6	24*
R167877	39963	2"	27"	6	24*
R167878	01481	2"	42"	6	24*
R167879	01500	2 1/4"	36"	6	24*
R167880	01538	2 1/2"	36"	6	24*
R167881	39964	3"	27"	6	24*
R167882	01491	3"	42"	6	24*

*May Be Assorted For Volume Quantity.

RICHARD SPECIALTY CO., INC.

CAT. NO.	MFG. NO.	SIZE	LENGTH (OAL)	FOR BOILER	BRUSH	STD. PACK	VOL. QTY.
SPECIALTY BOILER BRUSHES							
R167900	84006	1/2" X 1"	27"	Columbia	Wire	24	36*
R167901	84007	1/2" X 1"	48"	Columbia	Wire	12	36*
R167902	84009	2 1/4"	20"	Slant Fin	Tapered-Nylon	12	36*
R167903	84011	2 1/4"	20"	Slant Fin	Tapered, N, H.D.	6	36*
R167904	84023	1 7/8" to 1 1/8"	30"	Slant Fin	Tapered-Tampico	6	36*
R167905	84028	1 7/8" to 1 1/8"	30"		Tapered-Horse Hair	6	36*
R167906	84029	1/2" to 1"	42"		Tapered-Horse Hair	6	36*
R167907	84204	1 1/2" w/ 1 3/4" Flats	30"	Peerless	Galvanized	12	36*
R167908	84207	1 1/2" w/ 1 1/8" Flats	24"	WeilMclain	L.D. Horse Hair	6	36*
R167909	84200	1 1/2" w/ 1 1/8" Flats	30"	WeilMclain	Galvanized	24	36*
R167910	84205	1 1/2" w/ 1 1/8" Flats	30"	WeilMclain	H.D. Galvanized	12	36*
R167911	84210	1 1/2" w/ 1 1/8" Flats	42"	WeilMclain	Galvanized	12	36*
R167912	84201	1 1/2" w/ 1 1/8" Flats	30"	WeilMclain	H.D. Horse Hair	6	36*
R167913	84202	1 1/2" w/ 1 1/8" Flats	36"	WeilMclain	H.D. Horse Hair	12	36*
R167914	84211	1 1/2" w/ 1 1/8" Flats	42"	WeilMclain	H.D. Horse Hair	6	36*
R167915	84203	1 1/2" w/ 1 1/8" Flats	42"	WeilMclain	Heavy Duty	12	36"
R167916	84027	1 7/8" w/ 1 1/8" Tpr.dia.	42"		Horse Hair	12	36*
R167917	84212	1/2" to 1" Tapered dia.	36"		Horse Hair	6	36*
R167918	84214	1/2" to 1" Tapered dia.	30"		Horse Hair	6	36*
R167919	84215	1/2" to 1" Tapered dia.	30"		Tampico	6	36*
R167920	84216	1/2" to 1" Tapered dia.	21"		Horse Hair	6	36*
R167921	39950	2" X 6" U-Shape Fiber Red Brush			Tampico	6	36*

*May Be Assorted For Volume Quantity.

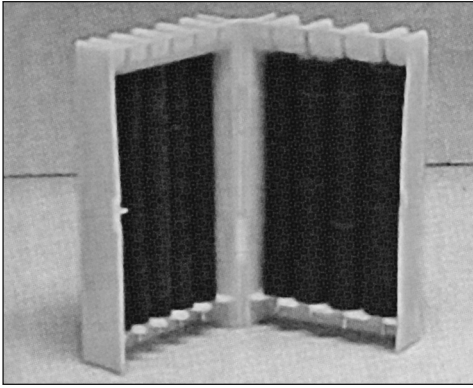

FAUCET WASHER BIBB CHEST

CAT. NO.	MFG. NO.	DESCRIPTION	BOX QTY.	VOL. QTY.
R167950		192 Assorted Beveled Washers (Buna N) Chemical Resistant - USA	1	6*
R167955		350 Assorted Flat Washers (Buna N) Chemical Resistant - USA	1	6*
R167960		170 Assorted Beveled Washers - Import	1	6*
R167965		345 Assorted Flat Washers - Import	1	6*

*May Be Assorted For Volume Quantity.

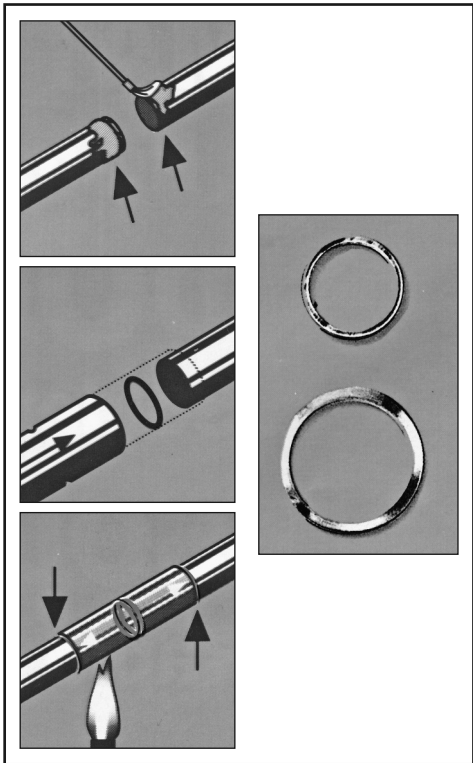

SOLDOMAT® RAPID - SOLDER RINGS

R167974	87506	3/4" (6 Per Package)	1	2
R167976	87550	3/4" (50 Per Package)	1	2
R167978	81002	1" (2 Per Package)	1	2
R167980	81010	1" (10 Per Package)	1	2

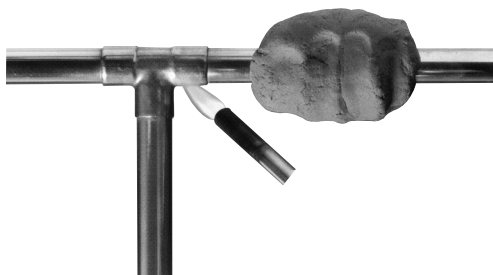

HOT DAM (Reusable)

Stops heat transfer in pipe. Molds like clay. Protects valves & works with Mapp gas, propane, arc or oxyacetylene welding on all ferrous & non-ferrous.

R167984		Hot Dam (3/4 Lb. Container)	1	2
---------	--	-----------------------------	---	---

RICHARD SPECIALTY CO., INC.

FILES	CAT. NO.	LENGTH	WIDTH	BOX QTY.	VOL. QTY.
SLIM TAPER (Triangular Saw File)					
	R168000	6"	21/64"	12	24*
	R168100	7"	25/64"	12	24*
	R168200	8"	15/32"	12	24*
EXTRA SLIM TAPER (Triangular Saw File)					
	R168400	6"	17/64"	12	24*
	R168500	7"	21/64"	12	24*
	R168600	8"	25/64"	12	24*
ROUND BASTARD FILES					
	R168700	6"	1/4"	12	24*
	R168800	8"	19/64"	12	24*
	R168900	10"	3/8"	12	24*
	R169000	12"	1/2"	12	24*
	R169100	14"	5/8"	12	24*
FLAT BASTARD FILES					
	R169300	6"	39/64" X 5/32"	12	24*
	R169400	8"	25/32" X 13/64"	12	24*
	R169500	10"	31/32" X 1/4"	12	24*
	R169600	12"	1 5/32" X 9/32"	12	24*
	R169700	14"	1 11/32" X 5/16"	12	24*
MILL BASTARD FILES					
	R170000	6"	19/32" X 7/64"	12	24*
	R170100	8"	25/32" X 9/64"	12	24*
	R170200	10"	31/32" X 11/64"	12	24*
	R170300	12"	15/32" X 7/64"	12	24"
	R170400	14"	1 5/16" X 1/4"	12	24*
HALF ROUND BASTARD FILES					
	R170700	8"	3/4" X 7/32"	12	24*
	R170800	10"	7/8" X 9/32"	12	24*
	R170900	12"	1 1/8" X 11/32"	12	24*
	R171000	14"	1 9/32" X 13/32"	6	24*
	HALF ROUND SHOE RASP				
	R171200	10"	1 1/16" X 11/32"	12	24*
FLAT SMOOTH FILES					
	R171400	8"	25/32" X 13/64"	12	24*
	R171500	10"	31/32" X 1/4"	12	24*
	R171600	12"	1 5/3" X 9/32"	12	24*
MILL SMOOTH FILES					
	R171900	8"	25/32" X 9/64"	12	24*
	R172000	10"	31/32" X 11/64"	12	24*
	R172100	12"	1 5/32" X 7/32"	12	24*
HALF ROUND SMOOTH FILES					
	R172400	8"	3/4" X 7/32"	12	24*
	R172500	10"	7/8" X 9/32"	12	24*
	R172600	12"	1 1/8" X 11/32"	12	24*

*May Be Assorted For Volume Quantity.

FILES	CAT. NO.	LENGTH	ITEM	BOX QTY.	VOL. QTY.
-------	----------	--------	------	----------	-----------

CARDED FILES (One File Per Card)

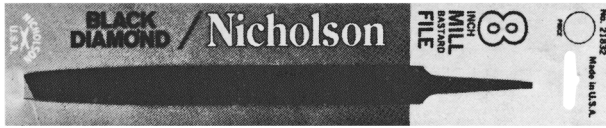

R173000	6"	Round Bastard	(1) 6cds	6
R173100	8"	Round Bastard	(1) 6cds	6
R173200	6"	Mill Bastard	(1) 6cds	6
R173300	8"	Mill Bastard	(1) 6cds	6
R173400	10"	Mill Bastard	(1) 6cds	6
R173500	12"	Mill Bastard	(1) 6cds	6
R173600	6"	Slim Taper	(1) 6cds	6
R173800	8"	Half Round	(1) 6cds	6
R173900	10"	Half Round	(1) 6cds	6
R174000	8"	4-in-Hand	(1) 6cds	6

FILE HANDLES	CAT. NO.	MFG. NO.	LENGTH	FITS FILE SIZES	BOX QTY.	VOL. QTY.
--------------	----------	----------	--------	-----------------	----------	-----------

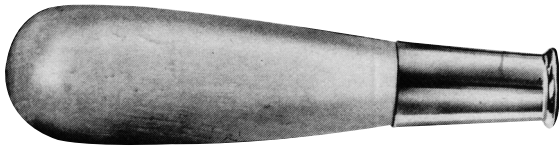

METAL FERRULED HANDLES

R174500	1	4"	3" - 6"	1	12
R174600	2	4 1/2"	6" - 8"	1	12
R174700	3	5"	8" - 12"	1	12
R174800	4	5 1/2"	12" - 16"	1	12
R174900	5	6"	16" - 20"	1	12

HAMMERS	CAT. NO.	WEIGHT HEAD	DESCRIPTION	BOX QTY.	VOL. QTY.
---------	----------	-------------	-------------	----------	-----------



WOOD HANDLE CLAW HAMMERS

R175000	16 oz.	Polished Head/Ripping Claw	(1)6	6
R175100	20 oz.	Polished Head/Ripping Claw	(1)6	6
R175200	16 oz.	Polished Face/Ripping Claw	(1)6	6
R175300	20 oz.	Polished Face/Ripping Claw	(1)6	6
R175400	16 oz.	Polished Head/Curved Claw	(1)6	6
R175500	20 oz.	Polished Head/Curved Claw	(1)6	6
R175600	16 oz.	Polished Face/Curved Claw	(1)6	6

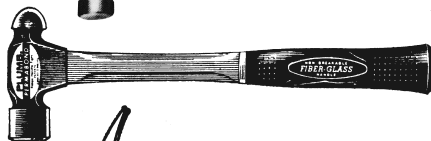

FIBER-GLASS HANDLE BALL PEIN HAMMERS

R176100	16 oz.	Polished Head & Peins	(1)4	4
R176300	24 oz.	Polished Head & Peins	(1)4	4
R176400	32 oz.	Polished Head & Peins	(1)4	4

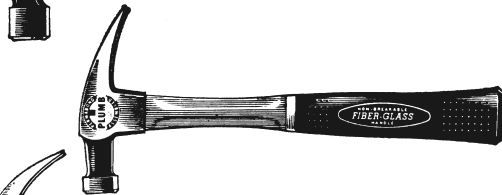

FIBER-GLASS CLAW HAMMERS

R176600	16 oz.	Polished Head/Ripping Claw	(1)4	4
R176700	20 oz.	Polished Head/Ripping Claw	(1)4	4
R176800	16 oz.	Polished Head/Curved Claw	(1)4	4
R176900	20 oz.	Polished Head/Curved Claw	(1)4	4
R177000	22 oz.	Polished Head/Ripping Claw	(1)4	4

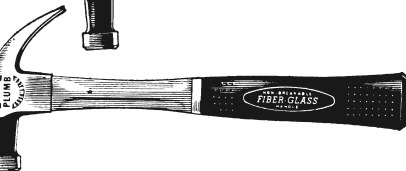

HALF HATCHET	CAT. NO.	MFG. NO.	DESCRIPTION	BOX QTY.	VOL. QTY.
--------------	----------	----------	-------------	----------	-----------

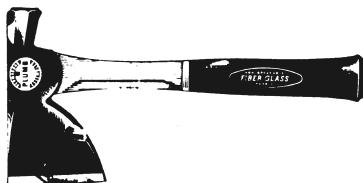

R177100	512-1B	3 1/2" Blade/Black Head, Wood Handle	(1)6	6
---------	--------	--------------------------------------	------	---

RICHARD SPECIALTY CO., INC.

HAMMERS		CAT. NO.	MFG. NO.	WEIGHT HEAD	DESCRIPTION	BOX QTY.	VOL. QTY.
LEATHER HANDLE HAMMERS							
	R177500	E16S	16 oz.	Straight Claw / Leather Handle	(1)4	4	
	R177600	E20S	20 oz.	Straight Claw / Leather Handle	(1)4	4	
	R177700	E16C	16 oz.	Straight Claw / Leather Handle	(1)4	4	
	R177800	E20C	20 oz.	Straight Claw / Leather Handle	(1)4	4	
TINNERS' RIVETING HAMMERS							
	R178100	T12	12 oz.	Polished Head / Leather Handle	(1)4	4	
	R178200	-	16 oz.	Black Head / Fiberglass Handle	(1)4	4	
	R178300	-	20 oz.	Polished Head / Rubber Grip Handle	(1)4	4	
SETTING HAMMERS							
	R178700	T-18	18 oz.	Polished Head / Leather Handle	(1)4	4	
WOOD HANDLE BALL PEIN HAMMERS							
Black finished head with polished face and pein.							
	R179000	5204	4 oz.		(1)6	6	
	R179100	5208	8 oz.		(1)6	6	
	R179200	5212	12 oz.		(1)6	6	
	R179300	5216	16 oz.		(1)6	6	
	R179400	5220	20 oz.		(1)6	6	
	R179500	5224	24 oz.		(1)6	6	
	R179600	5232	32 oz.		(1)6	6	
	R179700	5240	40 oz.		(1)4	4	
R179800	5248	48 oz.		(1)4	4		
SHORT CALKING HAMMER							
	R180000	5102-D	2 lb.	10 1/2" Hdle. Length	(1)4	4	
	R180100	5103-D	3 lb.	10 1/2" Hdle. Length	(1)4	4	
	R180200	5104-D	4 lb.	10 1/2" Hdle. Length	(1)4	4	
DOUBLE FACE HAMMER							
	R180300	5102	2 lb.	16" Hdle. Length	(1)4	4	
	R180400	5103	3 lb.	16" Hdle. Length	(1)4	4	
	R180500	5104	4 lb.	16" Hdle. Length	(1)4	4	
	R180600	5106	6 lb.	36" Hdle. Length	1	4	
	R180700	5108	8 lb.	36" Hdle. Length	1	4	
	R180800	5110	10 lb.	36" Hdle. Length	1	4	
	R180900	5112	12 lb.	36" Hdle. Length	1	4	
RUBBER HAMMERS For pounding paving bricks							
	R181000		8"	Rubber Hammer	1	4	
	R181005		10"	Rubber Hammer	1	4	
	R181010		18"	Rubber Hammer	1	4	
	R181015		35"	Rubber Hammer	1	4	
	Replacement Rubbers						
	R181020			18mm Head - Black	1	2	
	R181025			18mm Head - White	1	2	
	R181030			42mm Head - Black	1	2	
	R181035			42mm Head - White	1	2	
	R181350			Safety Goggles	1	6	

OIL CANS		CAT. NO.	MFG. NO.	CAPACITY	SPOUT LENGTH	BOX QTY.	VOL. QTY.
----------	--	----------	----------	----------	--------------	----------	-----------



R183300



R184700

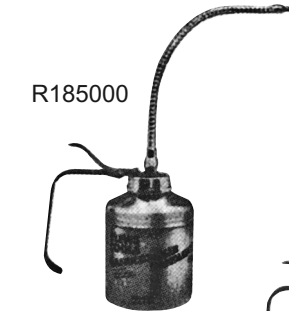

R185000



R185200

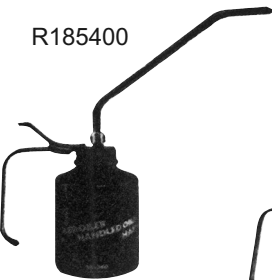

R185400



R185600



R185700



R185800



R186000



R186005

OIL CANS

R183300	33-F	6 oz.	6 1/2" Flexible	(1)6	6
---------	------	-------	-----------------	------	---

BENCH OILERS

Welded steel spouts with knurled steel spout bushings. Drawn steel bodies, spring steel bottoms. Flex spout features asbestos packed seam for leak resistance.

R184700	50-122	1Pint	6" Rigid	1	10
---------	--------	-------	----------	---	----

HANDLED OILERS

Powerful pumps with steel check valves. Full drawn, nickle plated bodies. Spout tips have a machined groove for lifting oil filler caps.

R185000	50-437	1Pint	9" Flexible	1	5
---------	--------	-------	-------------	---	---

HEAVY DUTY HANDLED OILERS

Full drawn, steel bodies have "Epoxycoate" finish. Flex-spout tip threaded 12-32. Rigid spouts are zinc plated.

R185200	50-337	1 Pint	9" Flexible	1	5
---------	--------	--------	-------------	---	---

R185400	50-340	1 Pint	9" Rigid 30° Bent Spout	1	5
---------	--------	--------	-------------------------	---	---

R185600	50-347	1 Quart	9" Flexible	1	5
---------	--------	---------	-------------	---	---

PISTOL OILERS

Full drawn "Epoxycoate" finish bodies. Ledge-cone machine tips to lift filler dust caps. Flex-spout has "Epoxycoate" finish.

R185700	50-515	6oz.	6" Rigid	1	10
---------	--------	------	----------	---	----

R185800	50-516	6oz.	6 1/2" Flexible	1	10
---------	--------	------	-----------------	---	----

R186000	50-573	1 Pint	6" Flexible	1	5
---------	--------	--------	-------------	---	---

ECONOMY OILER

R186005	50-595	8oz.	6" Flexible Hose	6	12
---------	--------	------	------------------	---	----

RICHARD SPECIALTY CO., INC.

PIPE REPAIR CLAMPS

CAT. NO. SIZE

BOX VOL. QTY. QTY.

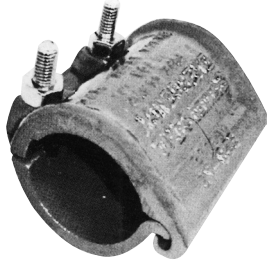

CAST IRON PIPE REPAIR CLAMPS - USA

Repairs Pit Holes, Splits and Corrosion Leaks.

		Torque	Heat up to 235°F Working Pressure		
R186020	1/2"	10 ft.lbs.	600 psi	1	6*
R186022	3/4"	10 ft.lbs.	600 psi	1	6*
R186024	1"	18 ft.lbs.	600 psi	1	6*
R186026	1 1/4"	18 ft.lbs.	600 psi	1	6*
R186028	1 1/2"	18 ft.lbs.	600 psi	1	6*
R186030	2"	40 ft.lbs.	600 psi	1	6*
R186032	2 1/2"	40 ft.lbs.	600 psi	1	6*
R186034	3"	40 ft.lbs.	500 psi	1	6*
R186038	4"	50 ft.lbs.	500 psi	1	6*
R186040	5"	50 ft.lbs.	450 psi	1	6*
R186042	6"	50 ft.lbs.	400 psi	1	6*
R186044	8"	60 ft.lbs.	300 psi	1	6*
R186046	10"	60 ft.lbs.	200 psi	1	6*
R186048	12"	60 ft.lbs.	200 psi	1	6*

*May Be Assorted For Volume Quantity.

CAT. NO. PIPE SIZE

BOX VOL. QTY. QTY.

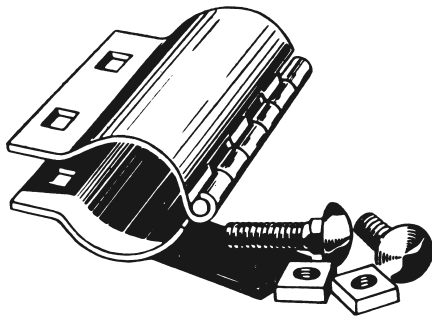

HINGED PIPE REPAIR CLAMP

Extra Heavy Duty Steel-Cadmium plated - with neoprene gasket.

R186200	1/2"	1	12*
R186300	3/4"	1	12*
R186400	1"	1	12*
R186500	1 1/4"	1	12*
R186600	1 1/2"	1	12"
R186700	2"	1	12*
R186800	2 1/2"	1	12*
R186900	3"	1	12*

*May Be Assorted For Volume Quantity.

CAT. NO. U.S.A. PIPE SIZE

CAT. NO. IMPORT PIPE SIZE

BOX VOL. QTY. QTY.



STAINLESS STEEL REPAIR CLAMPS

Fits IPS or Sch. 40 PVC -Not For Hot Water Line.

- Temperature Rating of -40°F to 212°F
- Pressure Rating of 150 PSI (Based on city water pressure)

	U.S.A.		IMPORT		
R187200	3/8" X 3"	R188400	3/8" X 3"	(1)6	12*
R187300	1/2" X 3"	R188405	1/2" X 3"	(1)6	12*
R187400	3/4" X 3"	R188410	3/4" X 3"	(1)6	12*
R187500	1" X 3"	R188415	1" X 3"	(1)6	12*
R187600	1 1/4" X 3"	R188420	1 1/4" X 3"	(1)6	12*
R187700	1 1/2" X 3"	R188425	1 1/2" X 3"	(1)6	12*
R187800	2" X 3"	R188430	2" X 3"	(1)4	12*
R187900	2 1/2" X 3"	R188435	2 1/2" X 3"	(1)4	12*
R188000	3" X 3"	R188440	3" X 3"	(1)4	12*
R188050	3 1/2" X 3"	-	-	(1)2	12*
R188100	4" X 3"	R188450	4" X 3"	(1)2	12*
R188200	5" X 3"	-	-	(1)2	12*
R188300	6" X 3"	R188460	6" X 3"	(1)2	12*

*May Be Assorted For Volume Quantity.

RICHARD SPECIALTY CO., INC.

PIPE REPAIR CLAMPS

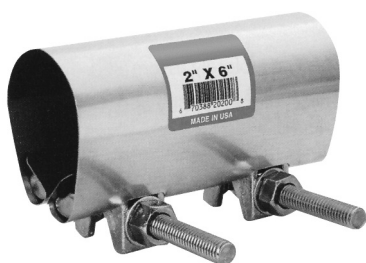

CAT. NO.	U.S.A. PIPE SIZE	CAT. NO.	IMPORT PIPE SIZE	BOX QTY.	VOL. QTY.
U.S.A.					
R188700	3/8" X 6"	R190000	3/8" X 6"	(1)3	12*
R188800	1/2" X 6"	R190005	1/2" X 6"	(1)3	12*
R188900	3/4" X 6"	R190010	3/4" X 6"	(1)3	12*
IMPORT					
R189000	1" X 6"	R190015	1" X 6"	(1)3	12*
R189100	1 1/4" X 6"	R190020	1 1/4" X 6"	(1)3	12*
R189200	1 1/2" X 6"	R190025	1 1/2" X 6"	(1)3	12*
R189300	2" X 6"	R190030	2" X 6"	(1)2	12*
R189400	2 1/2" X 6"	R190035	2 1/2" X 6"	(1)2	12*
R189500	3" X 6"	R190040	3" X 6"	(1)2	12*
R189550	3 1/2" X 6"	-	-	1	12*
R189600	4" X 6"	R190050	4" X 6"	1	12*
R189700	5" X 6"	-	-	1	12*
R189800	6" X 6"	R190060	6" X 6"	1	12*
R189900	8" X 6"	-	-	1	12*

*May Be Assorted For Volume Quantity.

CAT. NO.	PIPE SIZE	BOX QTY.	VOL. QTY.	CAT. NO.	PIPE SIZE	BOX QTY.	VOL. QTY.
----------	-----------	----------	-----------	----------	-----------	----------	-----------

IRON PIPE STEEL PATCH CLAMPS



R190100 - R190120



R190121 - RR190142

9" Wide – 3 Bolt

R190100	3/8" X 9"	(1)4	12*
R190101	1/2" X 9"	(1)4	12*
R190102	3/4" X 9"	(1)4	12*
R190103	1" X 9"	(1)4	12*
R190104	1 1/4" X 9"	(1)4	12*
R190105	1 1/2" X 9"	(1)3	12*
R190106	2" X 9"	(1)3	12*
R190107	2 1/2" X 9"	1	12*
R190108	3" X 9"	1	12
R190109	3 1/2" X 9"	1	12
R190110	4" X 9"	1	12
R190111	5" X 9"	1	12
R190112	6" X 9"	1	12
R190113	7" X 9"	1	12
R190114	8" X 9"	1	12
Below Clamps are 2-Band Clamps			
R190115	10" X 9"	1	12
R190116	12" X 9"	1	12
R190117	14" X 9"	1	12
R190118	16" X 9"	1	12
R190119	18" X 9"	1	12
R190120	20" X 9"	1	12

12" Wide – 4 Bolt

R190121	3/8" X 12"	(1)4	12*
R190122	1/2" X 12"	(1)4	12*
R190123	3/4" X 12"	(1)4	12*
R190124	1" X 12"	(1)4	12*
R190125	1 1/4" X 12"	(1)4	12*
R190126	1 1/2" X 12"	(1)3	12*
R190127	2" X 12"	(1)3	12*
R190128	2 1/2" X 12"	(1)2	12*
R190129	3" X 12"	(1)2	12*
R190130	3 1/2" X 12"	1	12*
R190131	4" X 12"	1	12*
R190132	5" X 12"	1	12*
R190133	6" X 12"	1	12*
R190134	7" X 12"	1	12*
R190135	8" X 12"	1	12*
Below Clamps are 2-Band Clamps			
R190136	10" X 12"	1	12*
R190137	12" X 12"	1	12*
R190138	14" X 12"	1	12*
R190139	16" X 12"	1	12*
R190140	18" X 12"	1	12*
R190141	20" X 12"	1	12*
R190142	24" X 12"	1	12*

*May Be Assorted For Volume Quantity.

RICHARD SPECIALTY CO., INC.

REPAIR COUPLINGS

CAT. NO.

PIPE SIZE

LENGTH

BOX VOL. QTY. QTY.

FLEXIBLE COMPRESSION COUPLINGS - GALVANIZED

120 PSI - 120°F

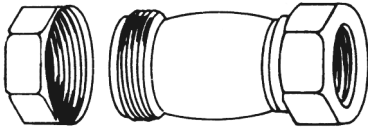

Regular Length

R190200	3/8"	2 5/16"	1	12*
R190300	1/2"	2 7/16"	1	12*
R190400	3/4"	2 3/4"	1	12*
R190500	1"	2 15/16"	1	12*
R190600	1 1/4"	3 1/8"	1	12*
R190700	1 1/2"	3 5/16"	1	12*
R190800	2"	3 9/16"	1	12*
R190900	2 1/2"	4 1/4"	1	12*
R191000	3"	4 3/4"	1	12*
R191100	4"	5 3/8"	1	12*

Long Length



R191500	1/2"	3 11/16"	1	12*
R191600	3/4"	4 1/8"	1	12*
R191700	1"	4 5/16"	1	12*
R191800	1 1/4"	4 1/2"	1	12*
R191900	1 1/2"	4 3/4"	1	12*
R192000	2"	5 1/16"	1	12*
R192010	2 1/2"	6 3/4"	1	12*
R192020	3"	7"	1	12*
R192030	4"	8 1/4"	1	12*

*May Be Assorted For Volume Quantity.
(Washers and Gaskets available for all sizes.)

125 PSI - 180°F

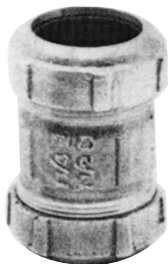

FLEXIBLE COMPRESSION COUPLINGS - BRONZE

IRON PIPE SIZE COPPER PIPE SIZE LENGTH

Regular Length

R192210	3/8"	1/2"	3"	1	12*
R192215	1/2"	3/4"	3"	1	12*
R192220	3/4"	1"	3"	1	12*
R192225	1"	1 1/4"	3"	1	12*
R192230	1 1/4"	1 1/2"	3"	1	12*
R192235	1 1/2"	-	3"	1	12*
R192240	2"	-	3"	1	12*

Long Length

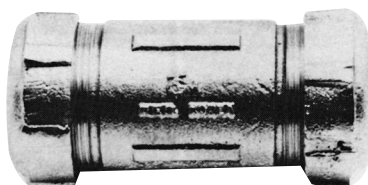

R192310	3/8"	1/2"	5"	1	12*
R192315	1/2"	3/4"	5"	1	12*
R192320	3/4"	1"	5"	1	12*
R192325	1"	1 1/4"	5"	1	12*
R192330	1 1/4"	1 1/2"	5"	1	12*
R192335	1 1/2"	-	5"	1	12*
R192340	2"	-	5"	1	12*
R192345	-	2"	5"	1	12*

*May Be Assorted For Volume Quantity.

150 PSI AT 73°F

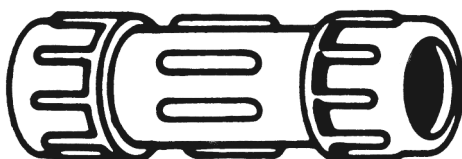

PLASTIC COUPLINGS

R192400	3/8"	4 1/2"	1	12*
R192500	1/2"	5"	1	12*
R192600	3/4"	5 1/4"	1	12*
R192700	1"	5 1/2"	1	12*
R192800	1 1/4"	6"	1	12*
R192900	1 1/2"	7"	1	12*
R193000	2"	7 1/2"	1	12*
R193100	2 1/2"	9"	1	12*
R193200	3"	10 1/4"	1	12*
R193300	4"	12"	1	12*
R193310	6"	12 1/2"	1	12*

*May Be Assorted For Volume Quantity.

PIPE REPAIR



PATCHABLES

R193312	PA-51	1/2" - 1"	1	12*
R193315	PA-154	1" - 4"	1	12*

*May Be Assorted For Volume Quantity.

PIPE REPAIR KIT

Repairs cracked or punctured copper/cast, iron/metal pipes, quickly and easily. Resin impregnated fiberglass tape sets like steel in under 30 minutes, even in water.

180 PSI - 600° F

R193340	2" X 60"	1/2", 3/4" & 1"	(1)12	12
R193345	3" X 108"	1 1/4" Thru 4"	(1)12	12

PETERSON FLUSHERS



R193400 to R193800

R194100

R194200 to R194240



R194400 to R196500



R196750 R196800

DRAIN JET (For The Plumber)

R193400	102-001	1 1/2"	3/4"	(1)2	6
R193500	102-002	2"	3/4"	(1)2	6
R193600	102-003	3"	3/4"	(1)2	6
R193700	102-004	4"	3/4"	(1)2	6
R193800	102-006	6"	3/4"	(1)2	4

MINI DRAIN JET

R194100	101-002	1 1/2" TO 2 1/2" Drains	(1)2	10
---------	---------	-------------------------	------	----

PRESSURE JET

The 103-Series has a 3/8" NPT connection for use with your power jetter and can double as a pipe plug (simply put a pipe plug in the outlet end, inflate up to 100 psi [60 psi for 6"], and use as a pipe plug). Constructed of heavy duty specially treated industrial fabric.

R194200	102-3001	1 1/2" Pressure Jet	1	2
R194210	102-3002	2" Pressure Jet	1	2
R194220	102-3003	3" Pressure Jet	1	2
R194230	102-3004	4" Pressure Jet	1	2
R194240	102-3006	6" Pressure Jet	1	2

HYDRAULIC SEWER FLUSHER

R194400	107-004-1	4"	1 1/2"	1"	26"	1	2
R194600	107-004-3	4"	2 1/2"	1 1/2"	27"	1	2
R194700	107-006-1	6"	1 1/2"	1"	29"	1	2
R194900	107-006-3	6"	2 1/2"	1 1/2"	30"	1	2
R195000	107-008-1	8"	1 1/2"	1"	32"	1	2
R195200	107-008-3	8"	2 1/2"	1 1/2"	33"	1	2
R195300	107-010-2	10"	2"	1 1/4"	40"	1	2
R195400	107-010-3	10"	2 1/2"	1 1/2"	40"	1	2
R195500	107-012-2	12"	2"	1 1/4"	48"	1	2
R195600	107-012-3	12"	2 1/2"	2"	48"	1	2
R195800	107-015-3	15"	2 1/2"	2"	60"	1	2
R196000	107-018-3	18"	2 1/2"	2"	72"	1	2
R196200	107-024-3	24"	2 1/2"	2"	84"	1	2
R196300	107-030-3	30"	2 1/2"	2"	96"	1	2
R196400	107-036-3	36"	2 1/2"	2"	108"	1	2
R196500	107-048-3	48"	2 1/2"	2"	132"	1	2

DR. FIXIT (For D.I.Y. Market)

R196750	100-004	1 1/4"-4"	3/4"	(1)10	10
R196800	100-006	3"-6"	3/4"	(1)10	10

RICHARD SPECIALTY CO., INC.

ANCHORS

CAT. NO.	MFG. No.	DRILL SIZE	ANCHOR LENGTH	SCREW LENGTH	BOX QTY.	VOL. QTY.
----------	----------	------------	---------------	--------------	----------	-----------



R199100
to
R199450

PLASTIC ANCHOR KITS

(Includes Anchors, Combo Screws, Carbide Drill)

R199100	PK-70-R	3/16"	7/8"	1"	(1)24	48**
R199200	PK-80-R	1/4"	1 1/8"	1 1/4"	(1)24	48**
R199300	*PK-85-R	1/4"	1 1/8"	1 1/4"	(1)24	48**
R199400	*PK-90-R	5/16"	1 1/4"	1 1/2"	(1)24	48**
R199450	*PK-95-R	3/8"	1 1/2"	2"	(1)24	48**

*PK-85-R and PK-90-R have 50 ea. anchors and screws.

*PK-95-R has 40 ea. anchors and screws. All other kits have 100 ea.

**May Be Assorted For Volume Quantity.

R199500
to
R199700



R199500	PK-70-S	3/16"	7/8"	1"	(1)24	24*
R199600	PK-80-S	1/4"	1"	1"	(1)24	24*
R199700	*PK-90-S	5/16"	1 1/4"	1 1/4"	(1)24	24*

*PK-90-S has 50 ea. anchors and screws. All other kits have 100 ea.

*May Be Assorted For Volume Quantity.



R199710
to
R199730

R199710	PK-70-H	3/16"	7/8"	1"	1	10
R199720	PK-80-H	1/4"	1"	1"	1	10
R199730	*PK-90-H	5/16"	1 1/4"	1 1/4"	1	10

PK-90-H has 50 ea. Anchors and screws. All other kits have 100 ea.

R199740 -
R199750

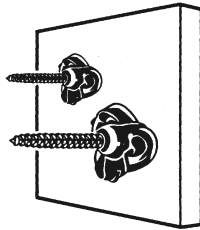

DRY AND HOLLOW WALL ANCHOR KITS

R199740	*PK-80-HW	1/4"	1 1/2"	2"	1	10
R199750	**PK-90-HW	5/16"	1 3/4"	2 1/2"	1	10

*PK-80-HW has 50 ea. Anchors and screws.

**PK-90-HW has 25 ea. Anchors and Screws.

R199800	K-6-R	1/4"	1"	1"	(1)24	24
R199900	K-8-R	3/16"	7/8"	1"	(1)24	24



R200000 - R200200

TAP-IT® - NYLON ANCHOR KITS

			(NAIL SIZE)		
R200000		3/16"	1"	1"	1 6
R200100		1/4"	1"	1"	1 6
R200200*		1/4"	1 1/2"	1 1/2"	1 6

*R200200 has 60 ea. anchors and nails. All others have 100 ea.



PK-80-R



K-6-R



PK-80-S

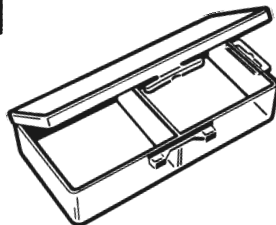

PLASTIC ANCHORS (Only)

			FOR KIT NUMBER		
R200500	54100	7/8"	(PK-70-R)	100	-
R200600	54200	1 1/8"	(PK-80-R)	100	-
R200700	54300	1 3/8"	(PK-90-R)	50	-
R200800		1"	(K-6-R)	100	-
R200900		1"	(PK-80-S)	100	-
R200950	Plastic Box			1	12

ANCHORS	CAT. NO.	SIZE	DRILL HOLE	BOX QTY.	VOL. QTY.
---------	----------	------	------------	----------	-----------

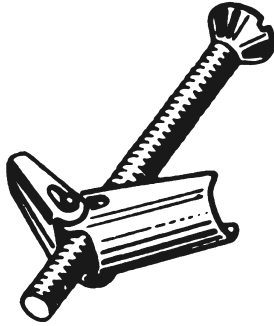

TOGGLE BOLTS (Spring - Wing Type)

R201000	1/8" X 2"	3/8"	100	300*
R201100	1/8" X 3"	3/8"	100	300*
R201200	1/8" X 4"	3/8"	100	300*
R201300	3/16" X 3"	9/16"	100	300*
R201400	3/16" X 4"	9/16"	50	300*
R201500	3/16" X 5"	9/16"	50	300*
R201600	3/16" X 6"	9/16"	50	300*
R201700	1/4" X 3"	3/4"	50	300*
R201800	1/4" X 4"	3/4"	50	300*
R201900	1/4" X 6"	3/4"	50	300*
R202000	3/8" X 3"	1"	25	300*
R202100	3/8" X 4"	1"	25	300*
R202200	3/8" X 6"	1"	25	300*
R202300	1/2" X 4"	1 5/16"	25	300*
R202400	1/2" X 6"	1 5/16"	25	300*



TOGGLE WINGS ONLY

R202500	1/8"	100	300*
R202600	3/16"	100	300*
R202700	1/4"	100	300*
R202800	3/8"	100	300*
R202900	1/2"	50	300*

*May Be Assorted For Volume Quantity.

CAT. NO.	SIZE	DIAMETER	DEPTH	BOX QTY.	VOL. QTY.
----------	------	----------	-------	----------	-----------



LEAD EXPANSION ANCHORS

(For machine screws. Used in hard masonry materials.)

R203500	1/4" - 20	1/2"	7/8"	100	200
R203600	5/16" - 18	5/8"	1"	100	200
R203700	3/8" - 16	3/4"	1 1/4"	50	100
R203800	1/2" - 13	1 1/8"	2"	50	100
R203900	5/8" - 11	1 1/8"	2"	50	100

CAT. NO.	BOLT SIZE	O.D. OF ANCHOR	DEPTH IN MASONRY	BOX QTY.	VOL. QTY.
----------	-----------	----------------	------------------	----------	-----------



SELF-DRILLING ANCHORS

"Snap-off" type. Installed with power hammer in hand masonry materials.

R204300	1/4"	7/16"	1 3/32"	100	300*
R204500	3/8"	9/16"	1 17/32"	100	300*
R204600	1/2"	11/16"	2 1/32"	100	300*
R204700	5/8"	27/32"	2 15/32"	100	300*
R204800	3/4"	1"	3 1/4"	100	300*

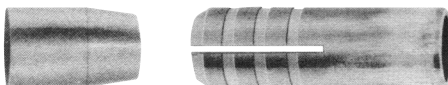

DROP-IN ANCHORS

R204900	1/4"	100	300*
R204905	3/8"	50	300*
R204910	1/2"	50	300*
R204915	5/8"	25	300*
R204920	3/4"	25	300*

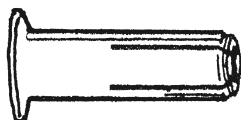

DROP-IN ANCHORS WITH LIP

R204926	1/4"	100	300*
R204928	3/8"	50	300*
R204930	1/2"	50	300*

*May Be Assorted For Volume Quantity.

RICHARD SPECIALTY CO., INC.

ANCHORS	CAT. NO.	MATERIAL	BOX QTY.	VOL. QTY.
----------------	-------------	----------	-------------	--------------

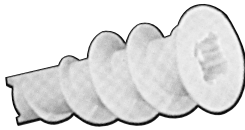

DRYWALL ANCHORS

R205000	Metal	100	500*
R205010	Nylon	100	500*

*May Be Assorted For Volume Quantity.

CAT. NO.	CAT. NO.	SIZE	BOX QTY.	VOL. QTY.
-------------	-------------	------	-------------	--------------

HAMMER DRIVE (Mushroom Head)



ZINC	NYLON w/ZINC PIN	SIZE	BOX QTY.	VOL. QTY.
R205100	-	3/16" X 7/8"	100	500*
-	R205155	3/16" X 1"	100	500*
-	R205160	3/16" X 1 1/2"	100	500*
R205115	R205165	1/4" X 3/4"	100	500*
R205120	R205170	1/4" X 1"	100	500*
R205125	-	1/4" X 1 1/4"	100	500*
R205130	R205180	1/4" X 1 1/2"	100	500*
R205135	R205185	1/4" X 2"	100	500*
R205140	-	1/4" X 2 1/2"	100	500*
R205145	R205190	1/4" X 3"	100	500*
-	R205195	1/4" X 4"	100	500*

*May Be Assorted For Volume Quantity.

WOOD SCREWS	CAT. NO.	SIZE	BOX QTY.	VOL. QTY.
--------------------	-------------	------	-------------	--------------

WOOD SCREWS

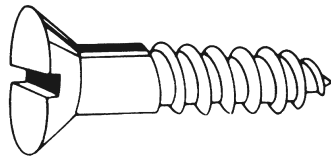

FLATHEAD WOOD SCREWS (Plated)

R206300	10 X 1 1/2"	100	500*
R206400	12 X 1 1/4"	100	500*
R206500	12 X 1 1/2"	100	500*
R206600	12 X 2"	100	500*
R206700	12 X 2 1/2"	100	500*
R206800	14 X 1 1/2"	100	500*
R206900	14 X 2"	100	500*
R207000	14 X 2 1/2"	100	500*
R207100	14 X 3"	100	500*
R207200	14 X 3 1/2"	100	500*

*May Be Assorted For Volume Quantity.

STOVE BOLTS	CAT. NO.	SIZE	BOX QTY.	VOL. QTY.
--------------------	-------------	------	-------------	--------------

STOVE BOLTS

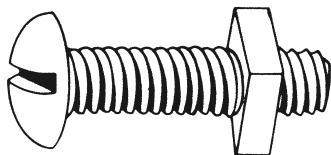

ROUND HEAD STOVE BOLTS (Plated)

R207300	3/16" X 1/2"	100	1000*
R207400	3/16" X 3/4"	100	1000*
R207500	3/16" X 1"	100	1000*
R207600	3/16" X 1 1/4"	100	1000*
R207700	3/16" X 1 1/2"	100	1000*
R207750	3/16" X 2"	100	1000*
R207800	1/4" X 1/2"	100	1000*
R207900	1/4" X 3/4"	100	1000*
R208000	1/4" X 1"	100	1000*
R208100	1/4" X 1 1/4"	100	1000*
R208200	1/4" X 1 1/2"	100	1000*
R208300	1/4" X 2"	100	1000*

Other sizes and lengths available upon request.

*May Be Assorted For Volume Quantity.

WASHERS

CAT. NO.	BOLT SIZE	I.D.	O.D.	BOX QTY.	VOL. QTY.
----------	-----------	------	------	----------	-----------

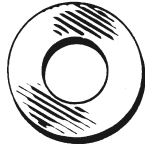

FLAT WASHERS USS WROUGHT

R208600	1/4"	5/16"	3/4"	100	1000*
R208700	5/16"	3/8"	7/8"	100	1000*
R208800	3/8"	7/16"	1"	100	1000*
R208900	1/2"	9/16"	1 3/8"	100	1000*
R209000	5/8"	11/16"	1 3/4"	100	1000*
R209100	3/4"	13/16"	2"	100	1000*
R209200	7/8"	15/16"	2 1/4"	100	1000*

*May Be Assorted For Volume Quantity.

CEILING, FENDER AND PLASTER WASHERS

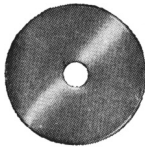

R209400	1/8"	9/64"	5/8"	100	500*
R209500	3/32"	3/16"	3/4"	100	500*
R209600	1/8"	5/32"	9/16"	100	500*
R209700	3/16"	13/64"	1/2"	100	500*
R209800	3/16"	7/32"	1 1/4"	100	500*
R209900	1/4"	17/64"	1/2"	100	500*
R210000	1/4"	17/64"	9/16"	100	500*
R210100	1/4"	17/64"	7/8"	100	500*
R210200	1/4"	9/32"	31/32"	100	500*
R210300	1/4"	9/32"	1 1/4"	100	500*
R210400	5/16"	21/64"	5/8"	100	500*
R210500	5/16"	11/32"	1 1/4"	100	500*
R210600	5/16"	11/32"	1 1/2"	100	500*
R210700	3/8"	13/32"	31/32"	100	500*
R210800	1/4"	9/32"	1 1/2"	100	500*
R210900	1/2"	17/32"	1 1/2"	100	500*
R211000	3/8"	13/32"	1 1/2"	100	500*
R211100	3/8"	13/32"	1 1/4"	100	500*
R211200	1/4"	9/32"	2"	50	500*
R211300	3/8"	13/32"	2"	50	500*
R211400	1/2"	17/32"	2"	50	500*

*May Be Assorted For Volume Quantity.

HEX NUTS

CAT. NO.	SIZE	BOX QTY.	VOL. QTY.
----------	------	----------	-----------

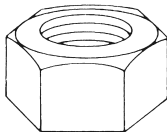

HEX NUTS-HEAVY

R211800	1/4" - 20	100	500*
R211900	5/16" - 18	100	500*
R212000	3/8" - 16	100	500*
R212100	7/16" - 14	100	500*
R212200	1/2" - 13	100	500*
R212300	9/16" - 12	50	500*
R212400	5/8" - 11	50	500*
R212500	3/4" - 10	25	500*
R212600	7/8" - 9	25	500*

*May Be Assorted For Volume Quantity.

RICHARD SPECIALTY CO., INC.

SCREWS SLOTTED

CAT. NO.
COMBO HEAD

CAT. NO.
HEX HEAD

SIZE

BOX
QTY.

VOL.
QTY.

SHEET METAL SCREWS

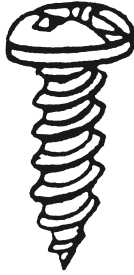

R213000 to R216300

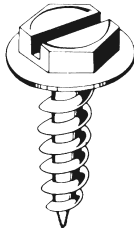

R217000 to R220300

R213000	R217000	3/8" X 6	100	1000*
R213100	R217100	1/2" X 6	100	1000*
R213200	R217200	3/4" X 6	100	1000*
R213300	R217300	1" X 6	100	1000*
-	R217400	1/2" X 7	100	1000*
-	R217500	3/4" X 7	100	1000*
-	R217600	1" X 7	100	1000*
-	-	1 1/2" X 7	100	1000*
R213800	R217800	1/2" X 8	100	1000*
R213900	R217900	3/4" X 8	100	1000*
R214000	R218000	1" X 8	100	1000*
R214100	R218100	1 1/4" X 8	100	1000*
R214200	R218200	1 1/2" X 8	100	1000*
R214300	R218300	2" X 8	100	1000*
R214400	R218400	1/2" X 10	100	1000*
R214500	R218500	3/4" X 10	100	1000*
R214600	R218600	1" X 10	100	1000*
R214700	R218700	1 1/4" X 10	100	1000*
R214800	R218800	1 1/2" X 10	100	1000*
R214900	R218900	2" X 10	100	1000*
R215000	R219000	3/4" X 12	100	1000*
R215100	R219100	1" X 12	100	1000*
R215200	R219200	1 1/4" X 12	100	1000*
R215300	R219300	1 1/2" X 12	100	1000*
R215400	R219400	2" X 12	100	1000*
R215500	R219500	2 1/2" X 12	100	1000*
R215600	R219600	3" X 12	100	1000*
R215700	R219700	3/4" X 14	100	1000*
R215800	R219800	1" X 14	100	1000*
R215900	R219900	1 1/4" X 14	100	1000*
R216000	R220000	1 1/2" X 14	100	1000*
R216100	R220100	2" X 14	100	1000*
R216200	R220200	2 1/2" X 14	100	1000*
R216300	R220300	3" X 14	100	1000*

*May Be Assorted For Volume Quantity.

TAPPING SCREWS (Special Steel - Zinc Plated) Self Tapping

(1000 PK.)

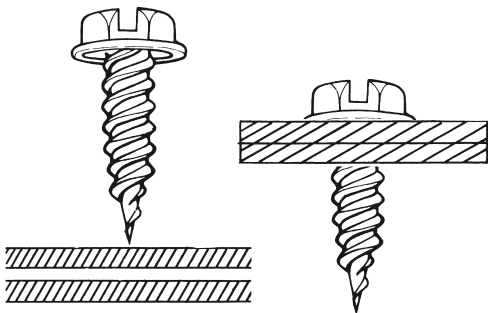

-	R221400	3/8" X 6	1	6
-	R221500	1/2" X 7	1	6
-	R221600	1/2" X 8	1	6
-	R221700	3/4" X 8	1	6
-	R221800*	1" X 8	1	6
-	R221900	1/2" X 10	1	6
-	R222000	3/4" X 10	1	6
-	R222100*	1" X 10	1	6
	*500 PK.			
	(100 PK.)			
R222200	R223200	3/8" X 6	1	6
-	R223300	1/2" X 7	1	6
R222400	R223400	1/2" X 8	1	6
R222500	R223500	3/4" X 8	1	6
R222600	R223600	1/2" X 10	1	6
R222700	R223700	3/4" X 10	1	6

MAGNETIC DRILL CHUCKS

CAT. NO.	SIZE	LENGTH	BOX QTY.	VOL. QTY.
----------	------	--------	----------	-----------

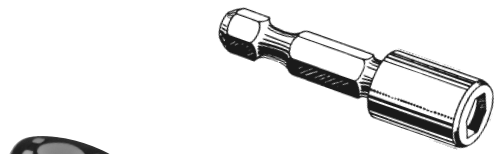

MAGNETIC DRILL CHUCK - FOR HEX HEAD SCREWS

R224000	1/4" Round	1 3/4"	1	12
R224100	1/4" Hex	1 3/4"	1	12
R224200	5/16" Hex	1 3/4"	1	12
R224300	3/8" Hex	2"	1	12



FLIP DRIVE

R224350	1/4" & 5/16" Hex Driver.	9 1/2"	1	6
---------	--------------------------	--------	---	---

Includes hand driver & drill driver.

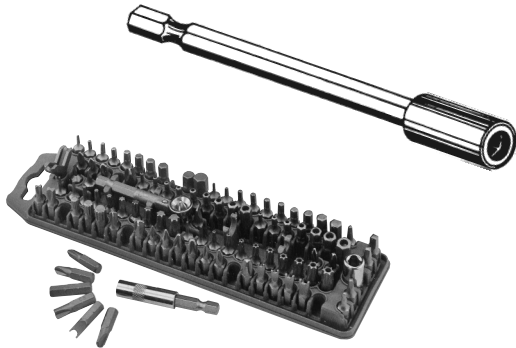

ADAPTER EXTENSIONS

R224400	1/4" Hex	4"	1	6
R224500	1/4" Hex	6"	1	6

R224700	100 pc. Power Bit Set		1	4
---------	-----------------------	--	---	---

WIRE PIPE HOOKS

CAT. NO. PLAIN STEEL	CAT. NO. COPPER COATED	CAT. NO. PLASTIC COATED	SIZE	BOX QTY.	VOL. QTY.
----------------------	------------------------	-------------------------	------	----------	-----------

QUALITY WIRE PIPE HOOKS

9 GAUGE WIRE (Plain, Copper Coated and Plastic Coated.)

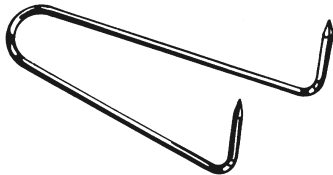

R225000	R227000	R229000	1/2" X 4"	50	500*
R225100	R227100	R229100	3/4" X 4"	50	500*
R225200	R227200	R229200	1" X 4"	50	500*
R225300	R227300	R229300	1 1/4" X 4"	50	500*
R225400	R227400	R229400	1 1/2" X 4"	50	500*
R225600	R227600	R229600	1/2" X 6"	50	500*
R225700	R227700	R229700	3/4" X 6"	50	500*
R225800	R227800	R229800	1" X 6"	50	500*
R225900	R227900	R229900	1 1/4" X 6"	50	500*
R226000	R228000	R230000	1 1/2" X 6"	50	500*
R226200	R228200	R230200	1/2" X 8"	50	500*
R226300	R228300	R230300	3/4" X 8"	50	500*
R226400	R228400	R230400	1" X 8"	50	500*
R226500	R228500	R230500	1 1/4" X 8"	50	500*
R226600	R228600	R230600	1 1/2" X 8"	50	500*

*May Be Assorted For Volume Quantity.

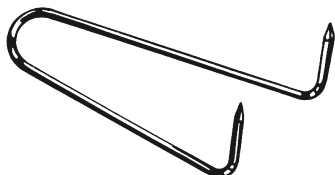

QUALITY WIRE PIPE HOOKS

12-1/2 GAUGE WIRE (Plain, Copper Coated and Plastic Coated.)

R231000	R231200	R231400	1/2" X 2 1/2"	100	1000
R231100	R231300	R231500	3/4" X 2 1/2"	100	1000

RICHARD SPECIALTY CO., INC.

PIPE STRAPS

CAT. NO. PLAIN STEEL	CAT. NO. COPPER COATED	CAT. NO. PLASTIC COATED	SIZE	BOX QTY.	VOL. QTY.
-------------------------	---------------------------	----------------------------	------	-------------	--------------

ONE HOLE PIPE STRAPS - ZINC PLATED



THIN WALL PIPE		HEAVY WALL PIPE			
R231534		R231554	1/2"	100	500*
R231536		R231556	3/4"	100	500*
R231538		R231558	1"	50	500*
-		R231560	1 1/4"	25	500*
-		R231562	1 1/2"	25	500*
-		R231564	2"	25	500*

TWO HOLE PIPE STRAPS (with Nails)

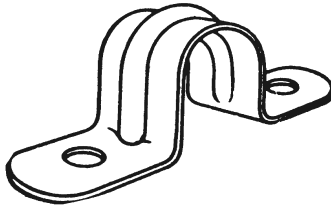

R231600	R232800	R233705	1/4"	100	500*
R231700	R232900	R233710	3/8"	100	500*
R231800	R233000	R233715	1/2"	100	500*
R231900	R233100	R233720	3/4"	100	500*
R232000	R233200	R233725	1"	100	500*
R232100	R233300	R233730	1 1/4"	100	500*
R232200	R233400	R233735	1 1/2"	50	500*
R232300	R233500	R233740	2"	50	500*
R232400	-	R233745	2 1/2"	25	500*
R232500	-	R233750	3"	25	500*
R232600	-	-	3 1/2"	25	500*
R232700	-	R233760	4"	25	500*

*May Be Assorted For Volume Quantity.

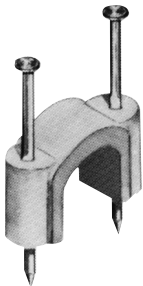

PLASTIC STRAP

(Preloaded with nails inserted; for 1/2", 3/4" & 1" copper or plastic tubing.)

R233800	P-500	1/2" Plastic Strap	100	1000
R233900	P-750	3/4" Plastic Strap	50	1000
R233901	P-1000	1" Plastic Strap	25	500

TUBE CLAMPS

CAT. NO.	SIZE	BOX QTY.	VOL. QTY.
----------	------	----------	-----------

TUBE CLAMP - PRELOADED NAIL

Durable poly construction eliminates corrosion and tubing damage. Use to hold copper, poly B, CPVC and PVC.

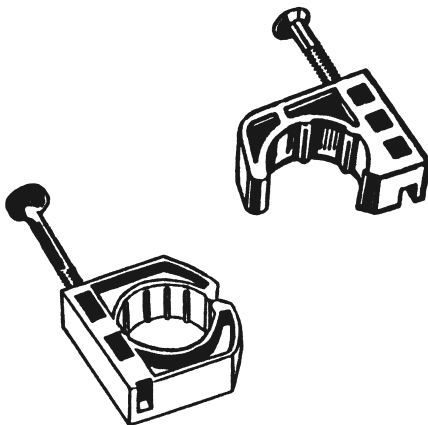

R233903	3/8"	100	1000
R233905	1/2"	100	1000
R233907	3/4"	100	1000
R233910	1"	50	500

TUBE CLAMP - PRELOADED NAIL

R233915	1/2"	100	1000
R233917	3/4"	50	500
R233920	1"	25	250

TUBE CLAMP

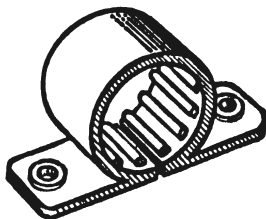

R233930	1/2"	100	1000
R233932	3/4"	100	1000
R233934	1"	50	500
R233936	1 1/4"	25	250
R233938	1 1/2"	25	250
R233940	2"	25	250

TUBE CLAMPS



CAT. NO.	SIZE	BOX QTY.	VOL. QTY.
SUSPENSION CLAMP			
R233950	1/2"	100	1000
R233952	3/4"	100	1000
R233954	1"	50	500
R233956	1 1/4"	25	250
R233958	1 1/2"	25	250
R233960	2"	25	250

J-HOOKS

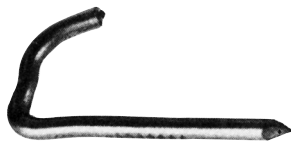

CAT. NO.	SIZE	DESCRIPTION	BOX QTY.	VOL. QTY.
J-HOOKS				
R234000	1/2"	CT or EMT and 3/8" Pipe	100	1000
R234100	3/4"	CT or EMT and 1/2" Pipe	100	1000

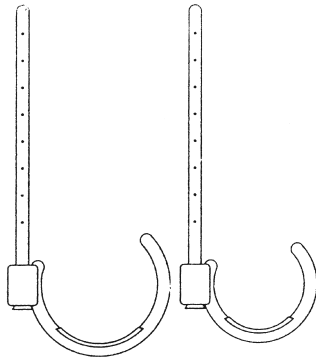

SWIVEL J-HOOK HANGER

Swivel saddle holds DWV, copper, polybutylene and CPVC pipe securely, yet allows for expansion and contraction. Made of ABS plastic - white.

R234103	1/2"	25	300*
R234104	3/4"	25	300*
R234105	1"	25	300*
R234106	1 1/4"	25	300*
R234107	1 1/2"	25	300*
R234108	2"	25	300*
R234109	3"	25	300*
R234110	4"	25	300*

Packed 25 per Ctn. 50 nails included in each package of 25.

*May Be Assorted For Volume Quantity.

SOLID BABY J-HOOKS - WHITE

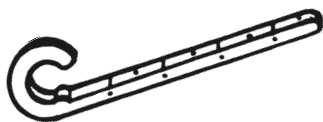

R234120	1/2" X 5"	CTS - Baby J-Hook	25	100*
R234122	3/4" X 5"	CTS - Baby J-Hook	25	100*
R234124	1" X 5"	CTS - Baby J-Hook	25	100*
R234126	1 1/4" X 5"	CTS - Baby J-Hook	25	100*

*May Be Assorted For Volume Quantity.

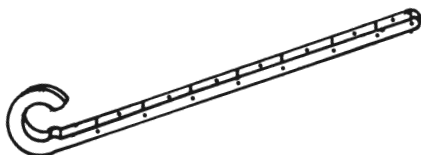

LONGER BABY J-HOOKS

R234134	1/2" X 7 1/2"	CTS - Longer J-Hook	25	300*
R234136	3/4" X 7 1/2"	CTS - Longer J-Hook	25	300*

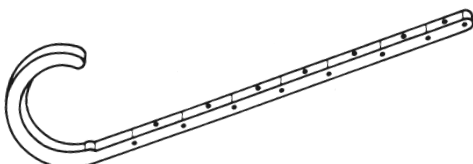

DWV J-HOOKS

R234150	1 1/2" X 7 1/2"	DWV - J-Hook	25	300*
R234152	2" x 7 1/2"	DWV - J-Hook	25	300*
R234154	3" x 7 1/2"	DWV - J-Hook	25	300*
R234156	4" x 7 1/2"	DWV - J-Hook	25	300*

J-Hooks packaged 25 per carton (bag), 50 nails included in each package of 25.

*May Be Assorted For Volume Quantity.

RICHARD SPECIALTY CO., INC.

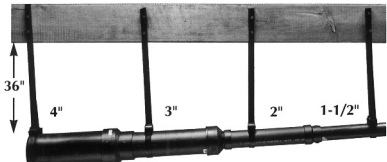
HANGABLES		CAT. NO.	BOX QTY.	VOL. QTY.
		HANGABLES™ (RELEASE TAB) For 1 1/2", 2", 3" & 4" DWV Schedule 40 pipe. 36" length each comes with 36" bar and 2 loop ends.	R234175	12 24

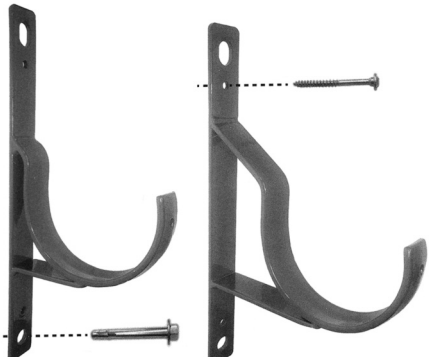

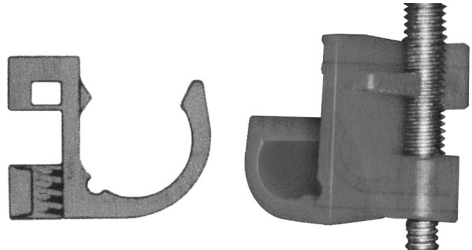

METAL HANGERS		CAT. NO.	DESCRIPTION	BOX QTY.	VOL. QTY.
		METAL HOOKS For hanging cast iron and PVC.			
	R234180	4" Straight Hanger	1	24	
	R234184	4" Offset Hanger	1	24	
	R234188	6" Straight Hanger	1	24	
	R234192	6" Offset Hanger	1	24	

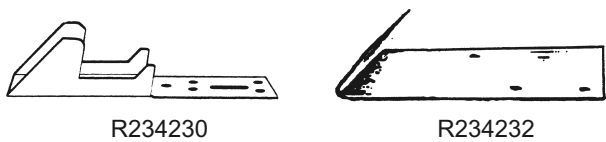
ADD A HANGER		CAT. NO.	DESCRIPTION	BOX QTY.	VOL. QTY.
		For 3/8" threaded rod			
	R234200	1/2"	25	200*	
	R234205	3/4"	25	200*	
	R234210	1"	25	200*	
*May Be Assorted For Volume Quantity.					

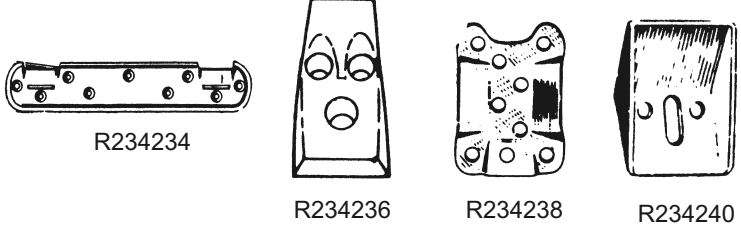
FLAT TUBE NAILER		CAT. NO.	DESCRIPTION	BOX QTY.	VOL. QTY.
		R234220	Copper Coated	100	1000
	R234222	Zinc Coated	100	1000	
	R234224	Plastic Coated	100	1000	

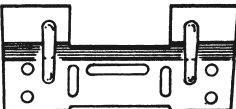
TUB HANGERS		CAT. NO.	DESCRIPTION	BOX QTY.	VOL. QTY.
		R234230	Tub Hanger	1	24
	R234232	Tub Hanger	1	24	

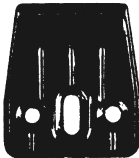
FIXTURE HANGERS		CAT. NO.	DESCRIPTION	BOX QTY.	VOL. QTY.
		R234234		1	12
	R234236		1	12	
	R234238		1	12	
	R234240		1	12	

TUB HANGERS		CAT. NO.	DESCRIPTION	BOX QTY.	VOL. QTY.
	R234250		LAVATORY HANGERS	1	12
	R234252			1	12
	R234256			1	12
	R234254			1	12
	R234258			1	12

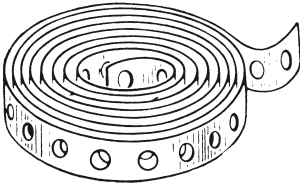
HANGER IRON		CAT. NO. 20 GA. GALV.	CAT. NO. 24 GA. GALV.	CAT. NO. 24 GA. COPPER COATED	LENGTH	BOX QTY.	VOL. QTY.
	PERFORATED HANGER IRON Galvanized and Copper coated						
	R234300	R234800	R235300		10'	10	50
	R234400	R234900	R235400		10' Bulk	100	200
	R234500	R235000	R235500		25'	6	12
	R234600	R235100	R235600		50'	1	6
	R234700	R235200	R235700		100'	1	6

PLASTIC HANGER STRAP		CAT. NO.	DESCRIPTION	BOX QTY.	VOL. QTY.
	R235710		10' Poly Bagged	1	20
	R235711		25' Poly Bagged	1	20
	R235712		50' Poly Bagged	1	20
	R235713		100' Poly Bagged	1	20
	R235714		100' Dispenser Box	1	20

PLASTIC WEDGES		CAT. NO.	DESCRIPTION	BOX QTY.	VOL. QTY.
	R235716		Plastic Wedges	100	500

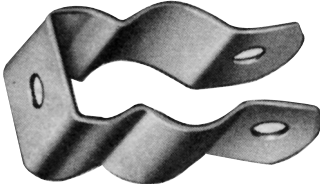
CONDUIT CLAMPS		CAT. NO. GALVANIZED	CAT. NO. COPPER PLATED	SIZE	BOX QTY.	VOL. QTY.
	R235720		R235750	3/8" - 1/2"	100	500*
	R235722		R235752	3/4"	50	500*
	R235724		R235754	1"	50	500*
	R235726		R235756	1 1/4"	50	500*
	R235728		R235758	1 1/2"	25	500*
	R235730		R235760	2"	25	500*
	R235732		R235762	2 1/2"	10	500*
	R235734		R235764	3"	10	500*
	R235736		R235766	3 1/2"	10	500*
	R235738		R235768	4"	10	500*

All conduit clamps come with bolts (not assembled).
* May Be Assorted For Volume Quantity.

RICHARD SPECIALTY CO., INC.

HANGER RING & BOLTS



CAT. NO. GALVANIZED	CAT. NO. COPPER PLATED	SIZE	BOX QTY.	VOL. QTY.
R235805	R235905	3/8"	50	200*
R235810	R235910	1/2"	50	200*
R235815	R235915	3/4"	50	200*
R235820	R235920	1"	50	200*
R235825	R235925	1 1/4"	50	200*
R235830	R235930	1 1/2"	50	200*
R235835	R235935	2"	50	200*
R235840	R235940	2 1/2"	25	200*
R235845	R235945	3"	25	200*
R235850	R235950	4"	25	200*

All hanger ring and bolts come with bolts. (not assembled).
 * May Be Assorted For Volume Quantity.

BELL HANGERS

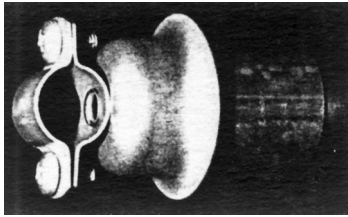

COPPER PLATED WITH SCREWS

To change the usual 3/4" stand-off distance from the wall -up to a maximum of 2"-simply cut a piece of 1" plastic or copper tubing and insert it into hanger.

CAT. NO.	SIZE	DESCRIPTION	BOX QTY.	VOL. QTY.
R235954	1/2"	Copper	25	100
R235955	3/4"	Copper	25	100
R235956	1"	Copper	25	100

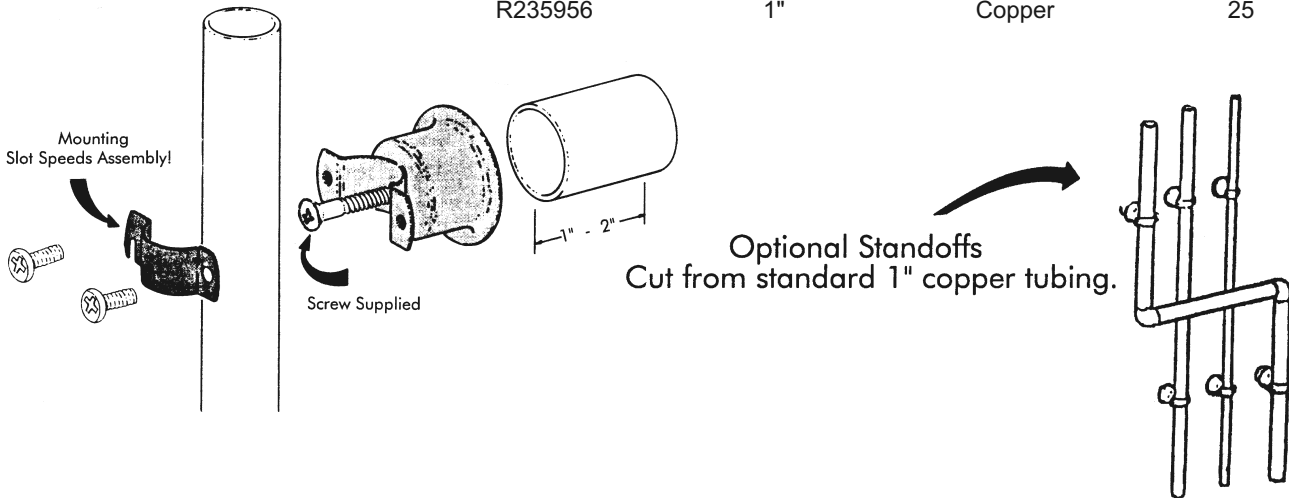

PIGTAIL SYPHONS



90°

CAT. NO.	DESCRIPTION	BOX QTY.	VOL. QTY.
R235960	Angle 90 1/4" Black Steel	1	12
R235962	Angle 90 1/4" Brass	1	12



180°

R235964	Straight 180 1/4" Black Steel	1	12
R235966	Straight 180 1/4" Brass	1	12

GAUGES	CAT. NO.	CONNECTION SIZE	FACE SIZE	RANGE	BOX QTY.	VOL. QTY.
--------	----------	-----------------	-----------	-------	----------	-----------

6" & 8-1/2" face gauges available upon request. Call for pricing.

PRESSURE GAUGES - P-500



R236000	1/4" LM	2"	15PSI	1	25*
R236100	1/4" LM	2"	30PSI	1	25*
R236200	1/4" LM	2"	60PSI	1	25*
R236300	1/4" LM	2"	100PSI	1	25*
R236400	1/4" LM	2" (Pump)	100PSI	1	25*

R236500	1/4" LM	2"	160PSI	1	25*
R236600	1/4" LM	2"	200PSI	1	25*
R236700	1/4" LM	2"	300PSI	1	25*
R236800	1/4" LM	2"	400PSI	1	25*
R236900	1/4" LM	2"	600PSI	1	25*
R237000	1/4" LM	2"	1000PSI	1	25*



R237100	1/4" LM	2 1/2"	15PSI	1	25*
R237200	1/4" LM	2 1/2"	30PSI	1	25*
R237300	1/4" LM	2 1/2"	60PSI	1	25*
R237400	1/4" LM	2 1/2"	100PSI	1	25*
R237500	1/4" LM	2 1/2"	160PSI	1	25*
R237600	1/4" LM	2 1/2"	200PSI	1	25*

R237700	1/4" LM	2 1/2"	300PSI	1	25*
R237800	1/4" LM	2 1/2"	400PSI	1	25*
R237900	1/4" LM	2 1/2"	600PSI	1	25*
R238000	1/4" LM	2 1/2"	1000PSI	1	25*
R238100	1/4" LM	2 1/2"	2000PSI	1	25*
R238200	1/4" LM	2 1/2"	3000PSI	1	25*
R238300	1/4" LM	2 1/2"	5000PSI	1	25*







R238400	1/4" LM	3 1/2"	15PSI	1	25*
R238500	1/4" LM	3 1/2"	30PSI	1	25*
R238600	1/4" LM	3 1/2"	60PSI	1	25*
R238700	1/4" LM	3 1/2"	100PSI	1	25*
R238800	1/4" LM	3 1/2"	160PSI	1	25*
R238900	1/4" LM	3 1/2"	200PSI	1	25*

R239000	1/4" LM	3 1/2"	300PSI	1	25*
R239100	1/4" LM	3 1/2"	400PSI	1	25*
R239200	1/4" LM	3 1/2"	600PSI	1	25*
R239300	1/4" LM	3 1/2"	1000PSI	1	25*

* All Pressure Vacuum and Compound Gauges May Be Assorted For The Volume Quantity.

RICHARD SPECIALTY CO., INC.

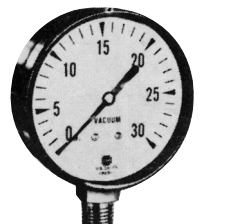
GAUGES	CAT. NO.	CONNECTION SIZE	FACE SIZE	RANGE	BOX QTY.	VOL. QTY.
PRESSURE GAUGES P-500						
	R239400	1/4" LM	4 1/2"	15PSI	1	25*
	R239500	1/4" LM	4 1/2"	30PSI	1	25*
	R239600	1/4" LM	4 1/2"	60PSI	1	25*
	R239700	1/4" LM	4 1/2"	100PSI	1	25*
	R239800	1/4" LM	4 1/2"	160PSI	1	25*
	R239900	1/4" LM	4 1/2"	200PSI	1	25*
	R240000	1/4" LM	4 1/2"	300PSI	1	25*
	R240100	1/4" LM	4 1/2"	400PSI	1	25*
	R240200	1/4" LM	4 1/2"	600PSI	1	25*
R240300	1/4" LM	4 1/2"	1000PSI	1	25*	
	R240360	1/8" LM	2"	15PSI	1	25*
	R240400	1/8" LM	2"	30PSI	1	25*
	R240500	1/8" LM	2"	60PSI	1	25*
	R240600	1/8" LM	2"	100PSI	1	25*
	R240700	1/8" LM	2"	160PSI	1	25*
	R240800	1/8" LM	2"	200PSI	1	25*
	R240810	1/8" LM	2"	300PSI	1	25*
	R240900	1/8" CBM	2"	30PSI	1	25*
	R241000	1/8" CBM	2"	60PSI	1	25*
	R241100	1/8" CBM	2"	100PSI	1	25*
	R241200	1/8" CBM	2"	160PSI	1	25*
	R241300	1/8" CBM	2"	200PSI	1	25*
	R241400	1/8" CBM	2"	300PSI	1	25*
	R241500	1/4" CBM	2"	15PSI	1	25*
	R241600	1/4" CBM	2"	30PSI	1	25*
	R241700	1/4" CBM	2"	60PSI	1	25*
	R241800	1/4" CBM	2"	100PSI	1	25*
	R241900	1/4" CBM	2"	160PSI	1	25*
	R242000	1/4" CBM	2"	200PSI	1	25*
	R242100	1/4" CBM	2"	300PSI	1	25*
	R242200	1/4" CBM	2"	600PSI	1	25*
	R242300	1/4" CBM	2 1/2"	15PSI	1	25*
	R242400	1/4" CBM	2 1/2"	30PSI	1	25*
	R242500	1/4" CBM	2 1/2"	60PSI	1	25*
	R242600	1/4" CBM	2 1/2"	100PSI	1	25*
	R242700	1/4" CBM	2 1/2"	160PSI	1	25*
	R242800	1/4" CBM	2 1/2"	200PSI	1	25*
	R242900	1/4" CBM	2 1/2"	300PSI	1	25*
	R243000	1/4" CBM	2 1/2"	600PSI	1	25*
	R243005	1/4" CBM	2 1/2"	1000PSI	1	25*
	R243010	1/4" CBM	2 1/2"	2000PSI	1	25*
	R243015	1/4" CBM	2 1/2"	3000PSI	1	25*
VACUUM GAUGES V-500						
	R243025	1/8" LM	1 1/2"	30"	1	25*
	R243030	1/8" LM	2"	30"	1	25*
	R243035	1/8" CBM	1 1/2"	30"	1	25*
	R243100	1/4" LM	2"	30"	1	25*
	R243200	1/4" LM	2 1/2"	30"	1	25*
R243300	1/4" LM	3 1/2"	30"	1	25*	
R243400	1/4" LM	4 1/2"	30"	1	25*	

*All Pressure Vacuum and Compound Gauges May Be Assorted For The Volume Quantity.

GAUGES		CAT. NO.	CONNECTION SIZE	FACE SIZE	RANGE	BOX QTY.	VOL. QTY.
COMPOUND GAUGES C-500							
	R243500	1/4" LM	2"	30" - 15PSI	1	25*	
	R243600	1/4" LM	2"	30" - 30PSI	1	25*	
	R243700	1/4" LM	2"	30" - 60PSI	1	25*	
	R243800	1/4" LM	2"	30" - 150PSI	1	25*	
	R244000	1/4" LM	2 1/2"	30" - 15PSI	1	25*	
	R244100	1/4" LM	2 1/2"	30" - 30PSI	1	25*	
	R244200	1/4" LM	2 1/2"	30" - 60PSI	1	25*	
	R244300	1/4" LM	2 1/2"	30" - 150PSI	1	25*	
	R244400	1/4" LM	2 1/2"	30" - 300PSI	1	25*	
	R244500	1/4" LM	3 1/2"	30" - 15PSI	1	25*	
	R244600	1/4" LM	3 1/2"	30" - 30PSI	1	25*	
	R244700	1/4" LM	3 1/2"	30" - 60PSI	1	25*	
R244800	1/4" LM	3 1/2"	30" - 150PSI	1	25*		
R244900	1/4" LM	3 1/2"	30" - 300PSI	1	25*		
R245000	1/4" LM	4 1/2"	30" - 15PSI	1	25*		
R245100	1/4" LM	4 1/2"	30" - 30PSI	1	25*		
R245200	1/4" LM	4 1/2"	30" - 60PSI	1	25*		
R245300	1/4" LM	4 1/2"	30" - 150PSI	1	25*		

* All Pressure Vacuum and Compound Gauges May Be Assorted For The Volume Quantity.

PRESSURE / TEMPERATURE TEST PLUGS		CAT. NO.	SIZE	BODY	BOX QTY.	VOL. QTY.
	600psi - 30°F to 275°F					
	R245410	1/4"	Brass	1	12	
R245420	1/2"	Brass	1	12		

GAUGES		CAT. NO.	MFG. NO.	CONNECTION SIZE	RANGE	FACE SIZE	BOX QTY.	VOL. QTY.
THERALTIMETERS - Pressure and Temperature								
	R245500	PT-1088 Straight	1/2" LM	75PSI - 60/260°F	3 1/2"	1	6*	
	R245600	PT-1088 Angle	1/2" LBM	75PSI - 60/260°F	3 1/2"	1	6*	
	R245700	PT-1088 Straight	1/2" LM	200PSI - 70/320°F	3 1/2"	1	6*	
	R245800	PT-1088 Angle	1/2" LBM	200PSI - 70/320°F	3 1/2"	1	6*	
	R245900	PT-1088 Angle	1/4" CBM	75PSI - 60/320°F	2 1/2"	1	6*	
	R245910	PT-1088 Angle	1/4" CBM	75PSI - 60/320°F	2 1/2"	1	6*	
	R245920	PT-1088 Straight	1/2" LM	75PSI - 60/260°F	3 1/2" SQ.	1	6*	
	R245930	PT-1088 Angle	1/2" LBM	75PSI - 60/260°F	3 1/2" SQ.	1	6*	

(R245900 Back Of Case To End Of Probe - 3-3/4")

(R245910 Back Of Case To End Of Probe - 2 1/2")

*May Be Assorted For Volume Quantity.

RICHARD SPECIALTY CO., INC.

GAUGES

CAT. NO.	MFG. NO.	CONNECTION SIZE	RANGE	FACE SIZE	BOX QTY.	VOL. QTY.
----------	----------	-----------------	-------	-----------	----------	-----------

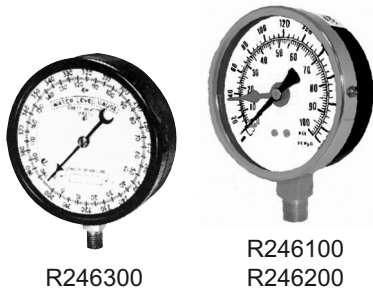

ALTITUDE & WATER LEVEL GAUGES

R246100	PA-503	1/4"LM	100PSI - 231'	3 1/2"	1	6
R246200	PA-503	1/4"LM	100PSI - 231'	4 1/2"	1	6
R246300		1/4"LM	0 - 370'	4 1/2"	1	6

R246300

R246100
R246200

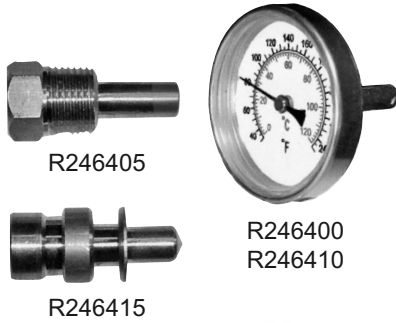

DIAL TYPE THERMOMETER – BI-METAL

R246400	1/2" MPT-CBM	1/2"IPS	32° - 248°F	2"	1	24*
R246405	Well Only			2"	1	24*
R246410	3/4" CWT Solder	3/4"CWT	32° - 248°F	2"	1	24*
R246415	Well Only			2"	1	24*

R246405

R246400
R246410

R246415

*May Be Assorted For Volume Quantity.



THERMOMETERS

R246500	T-571 Straight-Steel	1/2"LM	40° - 280°F	5"	1	12*
R246600	T-571 Straight-Brass	1/2"LM	40° - 280°F	5"	1	12*
R246700	T-572 Angle-Steel	1/2"LBM	40° - 280°F	5"	1	12*
R246800	T-572 Angle-Brass	1/2"LBM	40° - 280°F	5"	1	12*

R246700
R246800

R246500
R246600

*May Be Assorted For Volume Quantity.

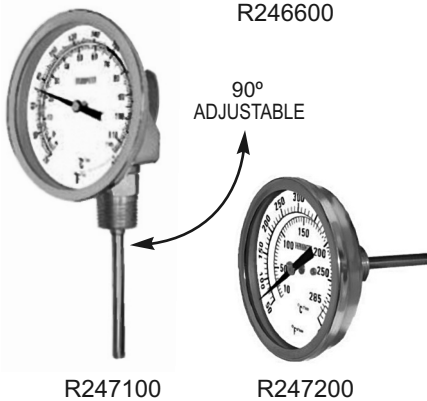

THERMOMETERS – BI-METAL (Adjustable Angle Type)

Every Angle Adjustable type thermometer features anti-vibration design, anti-parallax dial and hermetically sealed.

R247100	T-1050 Straight/Angle Adjustable	1/2"LM	60° - 260°F	3 1/2"	1	4
R247200	T-1051 Angle	1/2"LBM	60° - 260°F	3 1/2"	1	4

R247100

R247200



SPRINKLER GAUGES

R247206	P-1590	1/4"LM	300PSI	3 1/2"	1	6
R247210	R-1590	1/4"LM	0 - 80PSI	3 1/2"	1	6

R247206
R247210

GAUGES



R247215 to R247265

LOW PRESSURE DIAPHRAGM GAUGE

CAT. NO.	MFG. NO.	CONNECTION SIZE	RANGE	FACE SIZE	BOX QTY.	VOL. QTY.
R247215	P-734	1/4" LM	15"H ₂ O	2 1/2"	1	6
R247217	P-734	1/4" LM	30"H ₂ O	2 1/2"	1	6
R247220	P-734	1/4" LM	35"H ₂ O	2 1/2"	1	6
R247225	P-734	1/4" LM	60"H ₂ O	2 1/2"	1	6
R247230	P-734	1/4" LM	100"H ₂ O	2 1/2"	1	6
R247235	P-734	1/4" LM	200"H ₂ O	2 1/2"	1	6
R247240	P-734	1/4" LM	20oz	2 1/2"	1	6
R247245	P-734	1/4" LM	32oz	2 1/2"	1	6
R247250	P-734	1/4" LM	36oz	2 1/2"	1	6
R247255	P-734	1/4" LM	5PSI	2 1/2"	1	6
R247260	P-734	1/4" LM	10PSI	2 1/2"	1	6
R247265*	P-734	1/4" LM	20oz-35"	2 1/2"	1	6
R247270*	P-734	1/4" LM	35oz-60"	2 1/2"	1	6

*Used To Measure Gas Pressure.



R247302 to R247326

CORROSION & WEATHER RESISTANT GAUGES

R247302		1/4" LM	15PSI	2 1/2"	1	12*
R247304		1/4" LM	30PSI	2 1/2"	1	12*
R247306		1/4" LM	60PSI	2 1/2"	1	12*
R247308		1/4" LM	100PSI	2 1/2"	1	12*
R247310		1/4" LM	160PSI	2 1/2"	1	12*
R247312		1/4" LM	200PSI	2 1/2"	1	12*
R247314		1/4" LM	300PSI	2 1/2"	1	12*
R247316		1/4" LM	400PSI	2 1/2"	1	12*
R247318		1/4" LM	600PSI	2 1/2"	1	12*
R247320		1/4" LM	1000PSI	2 1/2"	1	12*
R247322		1/4" LM	1500PSI	2 1/2"	1	12*
R247324		1/4" LM	2000PSI	2 1/2"	1	12*
R247326		1/4" LM	3000PSI	2 1/2"	1	12*

*May Be Assorted For Volume Quantity.



R247401 to R247415

LIQUID FILLED GAUGES

ALL 701-L LIQUID FILLED WITH ACETAL PLASTIC CASE

R247401	701-L	1/4" LM	30"VAC	2 1/2"	1	12*
R247402	701-L	1/4" LM	15PSI	2 1/2"	1	12*
R247403	701-L	1/4" LM	30PSI	2 1/2"	1	12*
R247404	701-L	1/4" LM	60PSI	2 1/2"	1	12*
R247405	701-L	1/4" LM	100PSI	2 1/2"	1	12*
R247406	701-L	1/4" LM	160PSI	2 1/2"	1	12*
R247407	701-L	1/4" LM	200PSI	2 1/2"	1	12*
R247408	701-L	1/4" LM	300PSI	2 1/2"	1	12*
R247409	701-L	1/4" LM	400PSI	2 1/2"	1	12*
R247410	701-L	1/4" LM	600PSI	2 1/2"	1	12*
R247411	701-L	1/4" LM	1000PSI	2 1/2"	1	12*
R247412	701-L	1/4" LM	2000PSI	2 1/2"	1	12*
R247413	701-L	1/4" LM	3000PSI	2 1/2"	1	12*
R247414	701-L	1/4" LM	5000PSI	2 1/2"	1	12*
R247415	701-L	1/4" LM	10000PSI	2 1/2"	1	12*

*All P-701-L May Be Assorted For Volume Quantity.



R247416 to R247428

STAINLESS STEEL CASE (Liquid Filled)

R247416	202-L	1/4" CBM	15PSI	2 1/2"	1	12*
R247417	202-L	1/4" CBM	30PSI	2 1/2"	1	12*
R247418	202-L	1/4" CBM	60PSI	2 1/2"	1	12*
R247419	202-L	1/4" CBM	100PSI	2 1/2"	1	12*
R247420	202-L	1/4" CBM	160PSI	2 1/2"	1	12*
R247421	202-L	1/4" CBM	200PSI	2 1/2"	1	12*
R247422	202-L	1/4" CBM	300PSI	2 1/2"	1	12*
R247424	202-L	1/4" CBM	600PSI	2 1/2"	1	12*
R247425	202-L	1/4" CBM	1000PSI	2 1/2"	1	12*
R247426	202-L	1/4" CBM	2000PSI	2 1/2"	1	12*
R247427	202-L	1/4" CBM	3000PSI	2 1/2"	1	12*
R247428	202-L	1/4" CBM	5000PSI	2 1/2"	1	12*

*All 202-L May Be Assorted For Volume Quantity.

701-L & 202-L Replaces P-580-L.

RICHARD SPECIALTY CO., INC.

GAUGES

CAT. NO.	MFG. NO.	CONNECTION SIZE	RANGE	FACE SIZE	BOX QTY.	VOL. QTY.
----------	----------	-----------------	-------	-----------	----------	-----------

STAINLESS STEEL CASE (Liquid Filled)



R247430
to
R247452

Brass

R247430	V-201-L	1/4"LM	30"	2 1/2"	1	12*
R247431	C-201-L	1/4"LM	30" - 15PSI	2 1/2"	1	12*
R247432	C-201-L	1/4"LM	30" - 30PSI	2 1/2"	1	12*
R247433	C-201-L	1/4"LM	30" - 60PSI	2 1/2"	1	12*
R247434	C-201-L	1/4"LM	30" - 100PSI	2 1/2"	1	12*
R247435	C-201-L	1/4"LM	30" - 150PSI	2 1/2"	1	12*
R247436	201-L	1/4"LM	15PSI	2 1/2"	1	12*
R247437	201-L	1/4"LM	30PSI	2 1/2"	1	12*
R247438	201-L	1/4"LM	60PSI	2 1/2"	1	12*
R247439	201-L	1/4"LM	100PSI	2 1/2"	1	12*
R247440	201-L	1/4"LM	160PSI	2 1/2"	1	12*
R247441	201-L	1/4"LM	200PSI	2 1/2"	1	12*
R247442	201-L	1/4"LM	300PSI	2 1/2"	1	12*
R247443	201-L	1/4"LM	400PSI	2 1/2"	1	12*
R247444	201-L	1/4"LM	600PSI	2 1/2"	1	12*
R247445	201-L	1/4"LM	1000PSI	2 1/2"	1	12*
R247446	201-L	1/4"LM	1500PSI	2 1/2"	1	12*
R247447	201-L	1/4"LM	2000PSI	2 1/2"	1	12*
R247448	201-L	1/4"LM	3000PSI	2 1/2"	1	12*
R247449	201-L	1/4"LM	4000PSI	2 1/2"	1	12*
R247450	201-L	1/4"LM	5000PSI	2 1/2"	1	12*
R247451	201-L	1/4"LM	6000PSI	2 1/2"	1	12*
R247452	201-L	1/4"LM	10000PSI	2 1/2"	1	12*

*All 201-L May Be Assorted For Volume Quantity.

316 STAINLESS STEEL CASE (Liquid Filled)



R247455
to
R247478

Stainless Steel

R247455	V-301-L	1/4"LM	30"	2 1/2"	1	12*
R247456	C-301-L	1/4"LM	30" - 15PSI	2 1/2"	1	12*
R247457	C-301-L	1/4"LM	30" - 30PSI	2 1/2"	1	12*
R247458	C-301-L	1/4"LM	30" - 60PSI	2 1/2"	1	12*
R247459	C-301-L	1/4"LM	30" - 100PSI	2 1/2"	1	12*
R247460	C-301-L	1/4"LM	30" - 150PSI	2 1/2"	1	12*
R247462	301-L	1/4"LM	15PSI	2 1/2"	1	12*
R247463	301-L	1/4"LM	30PSI	2 1/2"	1	12*
R247464	301-L	1/4"LM	60PSI	2 1/2"	1	12*
R247465	301-L	1/4"LM	100PSI	2 1/2"	1	12*
R247466	301-L	1/4"LM	160PSI	2 1/2"	1	12*
R247467	301-L	1/4"LM	200PSI	2 1/2"	1	12*
R247468	301-L	1/4"LM	300PSI	2 1/2"	1	12*
R247469	301-L	1/4"LM	400PSI	2 1/2"	1	12*
R247470	301-L	1/4"LM	600PSI	2 1/2"	1	12*
R247471	301-L	1/4"LM	1000PSI	2 1/2"	1	12*
R247472	301-L	1/4"LM	1500PSI	2 1/2"	1	12*
R247473	301-L	1/4"LM	2000PSI	2 1/2"	1	12*
R247474	301-L	1/4"LM	3000PSI	2 1/2"	1	12*
R247475	301-L	1/4"LM	4000PSI	2 1/2"	1	12*
R247476	301-L	1/4"LM	5000PSI	2 1/2"	1	12*
R247477	301-L	1/4"LM	6000PSI	2 1/2"	1	12*
R247478	301-L	1/4"LM	10000PSI	2 1/2"	1	12*

*All 301-L May Be Assorted For Volume Quantity.

GAUGES



R247480 to R247493



R247496 to R247507

LIQUID FILLED - STAINLESS STEEL CASE (Brass Connection)

CAT. NO.	MFG. NO.	CONNECTION SIZE	RANGE	FACE SIZE	BOX QTY.	VOL. QTY.
R247480	201-L4	1/4" LM	30PSI	4"	1	12*
R247481	201-L4	1/4" LM	60PSI	4"	1	12*
R247482	201-L4	1/4" LM	100PSI	4"	1	12*
R247483	201-L4	1/4" LM	160PSI	4"	1	12*
R247484	201-L4	1/4" LM	200PSI	4"	1	12*
R247485	201-L4	1/4" LM	300PSI	4"	1	12*
R247486	201-L4	1/4" LM	400PSI	4"	1	12*
R247487	201-L4	1/4" LM	600PSI	4"	1	12*
R247488	201-L4	1/4" LM	1000PSI	4"	1	12*
R247489	201-L4	1/4" LM	1500PSI	4"	1	12*
R247490	201-L4	1/4" LM	2000PSI	4"	1	12*
R247491	201-L4	1/4" LM	3000PSI	4"	1	12*
R247492	201-L4	1/4" LM	6000PSI	4"	1	12*
R247493	201-L4	1/4" LM	10000PSI	4"	1	12*
R247496	202-L4	1/4" CBM	30PSI	4"	1	12*
R247497	202-L4	1/4" CBM	60PSI	4"	1	12*
R247498	202-L4	1/4" CBM	100PSI	4"	1	12*
R247499	202-L4	1/4" CBM	160PSI	4"	1	12*
R247500	202-L4	1/4" CBM	200PSI	4"	1	12*
R247501	202-L4	1/4" CBM	300PSI	4"	1	12*
R247502	202-L4	1/4" CBM	400PSI	4"	1	12*
R247503	202-L4	1/4" CBM	600PSI	4"	1	12*
R247504	202-L4	1/4" CBM	1000PSI	4"	1	12*
R247505	202-L4	1/4" CBM	3000PSI	4"	1	12*
R247506	202-L4	1/4" CBM	5000PSI	4"	1	12*
R247507	202-L4	1/4" CBM	10,000PSI	4"	1	12*

*May Be Assorted For Volume Quantity.

THERMOMETERS

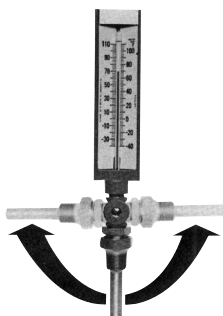

R247514 to R247535



R247537 - R247538

INDUSTRIAL MULTI-ANGLE THERMOMETERS

With 1 1/4" - 18 Swivel Nut (Less Brass Well)

CAT. NO.	MFG. NO.	SCALE	BULB	RANGE	BOX QTY.	VOL. QTY.
R247514	MN-9-035	9"	3 1/2"	-40 - 100°F	1	4*
R247516	MN-9-035	9"	3 1/2"	0 - 120°F	1	4*
R247518	MN-9-035	9"	3 1/2"	0 - 160°F	1	4*
R247520	MN-9-035	9"	3 1/2"	30 - 180°F	1	4*
R247522	MN-9-035	9"	3 1/2"	30 - 240°F	1	4*
R247524	MN-9-035	9"	3 1/2"	30 - 300°F	1	4*
R247528	MN-9-06	9"	6"	-40 - 110°F	1	4*
R247530	MN-9-06	9"	6"	0 - 120°F	1	4*
R247532	MN-9-06	9"	6"	0 - 160°F	1	4*
R247533	MN-9-06	9"	6"	30 - 180°F	1	4*
R247534	MN-9-06	9"	6"	30 - 240°F	1	4*
R247535	MN-9-06	9"	6"	30 - 300°F	1	4*
R247537	Solar Digital		3 1/2"	-50 - 320°F	1	4*
R247538	Solar Digital		6"	-50 - 320°F	1	4*
R247540			3 1/2" Brass Well		1	4*
R247542			6" Brass Well		1	4*

*May Be Assorted For Volume Quantity.

RICHARD SPECIALTY CO., INC.

GAUGES

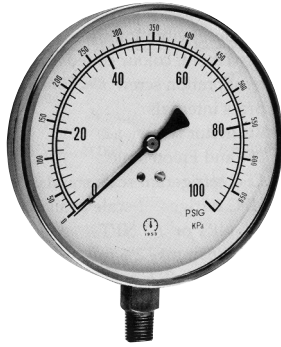

R247546
to
R247571

CAT. NO.	CONNECTION SIZE	RANGE	FACE SIZE	BOX QTY.	VOL. QTY.
----------	-----------------	-------	-----------	----------	-----------

MECHANICAL CONTRACTORS GAUGES (Stainless Steel Case)

R247546	1/4"LM	30"	4 1/2"	1	6*
R247548	1/4"LM	30" - 30PSI	4 1/2"	1	6*
R247550	1/4"LM	30" - 60PSI	4 1/2"	1	6*
R247552	1/4"LM	30" - 100PSI	4 1/2"	1	6*
R247554	1/4"LM	15PSI	4 1/2"	1	6*
R247556	1/4"LM	30PSI	4 1/2"	1	6*
R247558	1/4"LM	60PSI	4 1/2"	1	6*
R247560	1/4"LM	100PSI	4 1/2"	1	6*
R247562	1/4"LM	160PSI	4 1/2"	1	6*
R247564	1/4"LM	200PSI	4 1/2"	1	6*
R247566	1/4"LM	300PSI	4 1/2"	1	6*
R247568	1/4"LM	600PSI	4 1/2"	1	6*
R247570	1/4"LM	1000PSI	4 1/2"	1	6*
R247571	1/4"LM	3000PSI	4 1/2"	1	6*

* May Be Assorted For Volume Quantity.

THERMOMETERS

CAT. NO.	MFG. NO.	SCALE	RANGE	BOX QTY.	VOL. QTY.
----------	----------	-------	-------	----------	-----------

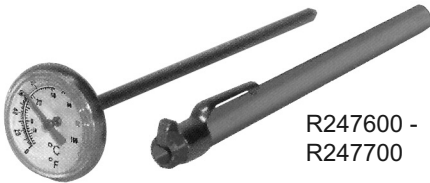

R247600 -
R247700

POCKET THERMOMETERS

R247600	ET-160	1" Dial	-40° - 160°F	1	12
R247700	ET-220	1" Dial	0° - 220°F	1	12
R248200	D-5008	1 3/4" Dial	-60° - 120°F	1	6
R248300	D-5009	1 3/4" Dial	0° - 230°F	1	6

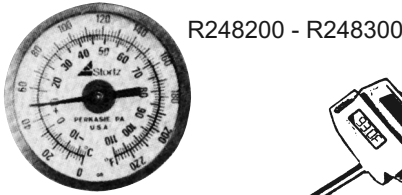

R248200 - R248300

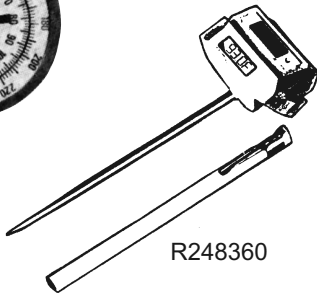

R248360

DIGITAL SWIVEL HEAD THERMOMETER

Head reads at any angle. Swivels 180° for tough to read locations. Stem sheath with pocket clip included.

R248360	Swivel Head		-50° - 300°F	1	6
---------	-------------	--	--------------	---	---

PRESSURE SNUBBER

CAT. NO.	MFG. NO.	NPT	HEX SIZE	LENGTH	HOUSING MAT	BOX QTY.	VOL. QTY.
----------	----------	-----	----------	--------	-------------	----------	-----------

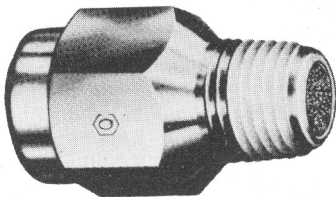

R248600	25B	1/4"	3/4"	2 1/2"	Brass	1	12
R248700	25S	1/4"	3/4"	2 1/2"	Stainless (303)	1	12
R248800	25M	1/4"	3/4"	2 1/2"	Monel	1	12
R248900	25S6	1/4"	3/4"	2 1/2"	Stainless (316)	1	12

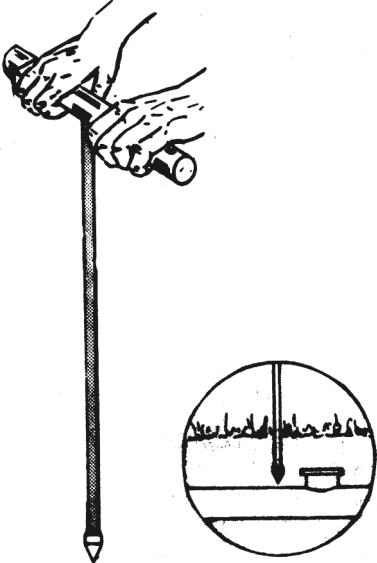
TILE PROBE		CAT. NO.	SIZE	BOX QTY.	VOL. QTY.
STEEL - PROBES					
	R248990	2'	1	20*	
	R249000	3'	1	20*	
	R249100	4'	1	20*	
	R249200	5'	1	20*	
	R249300	6'	1	20*	
	R249350	2' Extension	1	20*	
	R249400	3' Extension	1	20*	
	R249405	4' Extension	1	20*	
	R249410	5' Extension	1	20*	
	R249420	6' Extension	1	20*	
	R249500	Handle	1	20*	
	R249600	Coupling	1	20*	
	R249700	Replacement Tips	1	20*	
	FIBERGLASS - PROBES				
R249910	4'	1	20*		
R249915	5'	1	20*		
R249925	Replacement Tip	1	20*		

*May Be Assorted For Volume Quantity.

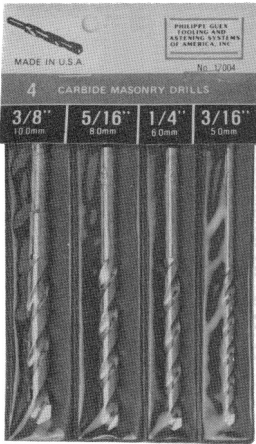
DRILL BITS		CAT. NO.	SIZE	SHANK DIAMETER	OVERALL LENGTH	BOX QTY.	VOL. QTY.	
MASONRY DRILLS (Carbide Tipped)								
 	R251600	1/8"	1/8"	3"	1	24*		
	R251900	3/16"	3/16"	4"	1	24*		
	R251950	3/16"	3/16"	6"	1	24*		
	R252100	1/4"	1/4"	4"	1	24*		
	R252150	1/4"	1/4"	6"	1	24*		
	R252300	5/16"	1/4"	4"	1	24*		
	R252350	5/16"	1/4"	6"	1	24*		
	R252400	3/8"	1/4"	4"	1	24*		
	R252450	3/8"	1/4"	6"	1	24*		
	R252500	7/16"	1/4"	6"	1	24*		
	R252600	1/2"	1/4"	6"	1	24*		
	R252700	1/2"	3/8"	6"	1	24*		
	R252800	9/16"	3/8"	6"	1	24*		
	R252900	5/8"	1/2"	6"	1	24*		
	R253000	11/16"	1/2"	6"	1	24*		
	R253100	3/4"	1/2"	6"	1	24*		
	R253200	7/8"	1/2"	6"	1	24*		
	R253300	1"	1/2"	6"	1	24*		
	*May Be Assorted For Volume Quantity.							
	R253400	Set	4 Drills 3/16"-1/4"-5/16"-3/8"			1	2	
R253500	Set	5 Drills 3/16"-1/4"-5/16"-3/8"-1/2"			1	2		

R253400
R253500



MASONRY PILOT/DRIVER KIT

R253600 Kit Consisting Of: 1 2
 8 pc. Masonry Pilot/Driver Kit in Case, 1/4" Masonry Nutsetter
 5/16" Masonry Nutsetter, Pilot Bit Holder, Sleeve Assembly
 Masonry Bit Holder, Set Screw, Hex Key, #2 Phillips Insert Bit
 & #3 Phillips Insert Bit.

RICHARD SPECIALTY CO., INC.

DRILL BITS	CAT. NO.	SIZE	SHANK DIAMETER	OVERALL LENGTH	BOX QTY.	VOL. QTY.
------------	----------	------	----------------	----------------	----------	-----------



MASONRY DRILLS 12" LONG

R253805	1/4"	1/4"	12"	1	6*
R253810	5/16"	1/4"	12"	1	6*
R253815	3/8"	1/4"	12"	1	6*
R253820	7/16"	3/8"	12"	1	6*
R253825	1/2"	3/8"	12"	1	6*
R253830	9/16"	3/8"	12"	1	6*
R253835	5/8"	1/2"	12"	1	6*
R253840	3/4"	1/2"	12"	1	6*
R253845	7/8"	1/2"	12"	1	6*
R253850	1"	1/2"	12"	1	6*

*May Be Assorted For Volume Quantity.

MASONRY DRILLS 18" LONG

R253902	1/4"	1/4"	18"	1	3*
R253904	5/16"	1/4"	18"	1	3*
R253906	3/8"	1/4"	18"	1	3*
R253908	7/16"	3/8"	18"	1	3*
R253910	1/2"	3/8"	18"	1	3*
R253912	9/16"	1/2"	18"	1	3*
R253914	5/8"	1/2"	18"	1	3*
R253916	3/4"	1/2"	18"	1	3*
R253918	7/8"	1/2"	18"	1	3*
R253920	1"	1/2"	18"	1	3*

* May Be Assorted For Volume Quantity.

	CAT. NO.	JOBBER LENGTH	BOX QTY.	VOL. QTY.
--	----------	---------------	----------	-----------

HIGH SPEED TWIST DRILLS



R254300	1/16"	5	10
R254400	5/64"	5	10
R254500	3/32"	5	10
R254600	7/64"	5	10
R254700	1/8"	5	10
R254800	9/64"	5	10
R254900	5/32"	5	10
R255000	11/64"	5	10
R255100	3/16"	5	10
R255200	13/64"	5	10
R255300	7/32"	5	10
R255400	15/64"	5	10
R255500	1/4"	5	10
R255600	17/64"	1	5
R255700	9/32"	1	5
R255800	19/64"	1	5
R255900	5/16"	1	5
R256000	21/64"	1	5
R256100	11/32"	1	5
R256200	23/64"	1	5
R256300	3/8"	1	5
R256400	25/64"	1	5
R256500	13/32"	1	5
R256600	27/64"	1	5
R256700	7/16"	1	5
R256800	29/64"	1	5
R256900	15/32"	1	5
R257000	31/64"	1	5
R257100	1/2"	1	5
R261000	#7	12	24

DRILL BITS

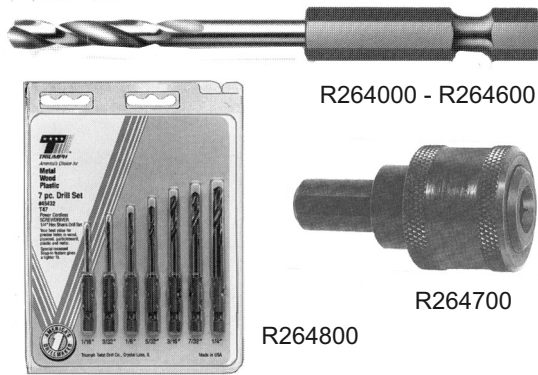

1/4" HEX SHANK DRILL BITS (For Power Cordless Drills)

CAT. NO.	SIZE	SHANK DIAMETER	OVERALL LENGTH	BOX QTY.	VOL. QTY.
R264000	1/16"	5/8"	2 1/4"	1	6
R264100	3/32"	3/4"	2 7/16"	1	6
R264200	1/8"	7/8"	2 5/8"	1	6
R264300	5/32"	1"	2 13/16"	1	6
R264400	3/16"	1 1/8"	3"	1	6
R264500	7/32"	1 1/4"	3 1/8"	1	6
R264600	1/4"	1 3/8"	3 3/16"	1	6
R264700	Quick Change Chuck Adapter			1	5
R264800	7 Piece Set			1	2

CAT. NO.	SIZE	OVERALL LENGTH	BOX QTY.	VOL. QTY.
----------	------	----------------	----------	-----------

PIN VISE

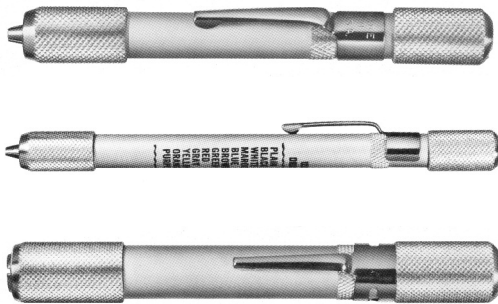

R268400	11100 Commando		1	6
Contains 12 Drills in assorted sizes #52 thru #74.				
R268410	11200 Tip Wire Kit		1	6
Contains 12 color coded, 4" long stainless steel wires, in assorted sizes. Covers drills from #49 thru #75. Holds wires or drills from #52 thru #80.				
R268420	11400 Commando		1	6
Holder with built-in chuck. Holds drills from #10 thru #52 and taps from #4 thru #10. Drills and taps not included.				

DOUBLE END DRILLS



R268500	7/64"	1 7/8"	12	36
R268600	1/8"	2"	12	36
R268700	9/64"	2"	12	36
R268800	5/32"	2 1/16"	12	36
R268900	3/16"	2 3/16"	12	36
R269000	7/32"	2 3/16"	12	36
R269100	1/4"	2 1/2"	12	36
R269200	#11	2 1/4"	12	36
R269300	#20	2 1/8"	12	36
R269400	#30	2"	12	36

CAT. NO.	SIZE	CAT. NO.	SIZE	BOX QTY.	VOL. QTY.
----------	------	----------	------	----------	-----------

HIGH SPEED TWIST DRILL (With 1/2" Shank)



R271900	17/32"	R273100	29/32"	1	3
R272000	9/16"	R273200	15/16"	1	3
R272100	19/32"	R273300	31/32"	1	3
R272200	5/8"	R273400	1"	1	3
R272300	21/32"	R273500	1 1/16"	1	3
R272400	11/16"	R273600	1 1/8"	1	3
R272500	23/32"	R273700	1 3/16"	1	3
R272600	3/4"	R273800	1 1/4"	1	3
R272700	25/32"	R273900	1 5/16"	1	3
R272800	13/16"	R274000	1 3/8"	1	3
R272900	27/32"	R274100	1 7/16"	1	3
R273000	7/8"	R274200	1 1/2"	1	3

Available in 64th Sizes at Price of Next Larger Drill.

RICHARD SPECIALTY CO., INC.

DRILL BITS

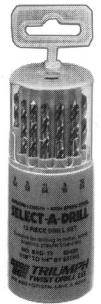
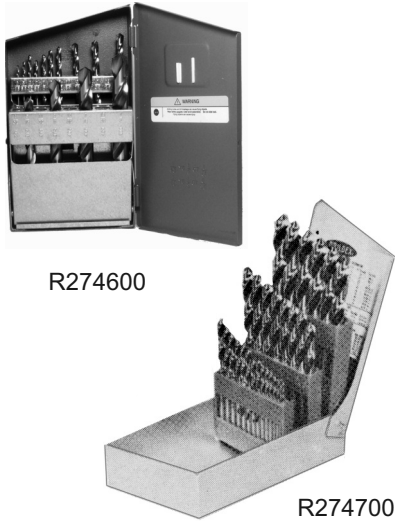

DRILL KITS

CAT. NO.	MFG. NO.	DESCRIPTION	BOX QTY.	VOL. QTY.
R274400	SAD-13	Round Plastic Case 13 PC 1/16" to 1/4"	1	6*
R274500	T-13-P	Plastic Case 13 PC 1/16" to 1/4"	1	6*
R274600	T-14-P	Plastic Case 14 PC 1/16" to 1/2" 5/16" and Larger have 1/4" shank	1	6*
R274700	T-17	Metal Case 29 PC 1/16" to 1/2" by 64ths	1	6*
R274800	T-18	Metal Case 15 PC 1/16" to 1/2" by 32nds	1	6*
R274900	T-19	Metal Case 13 PC 1/16" to 1/4"	1	6*
R275000	T-180	Metal Case 21 PC 1/16" to 3/8"	1	6*
R275100	T-22	Metal Case 60 PC #1 to #60	1	6*
R275200	T-23	Metal Case 20 PC #61 to #80	1	6*
R275300	T-98	Metal Case 8 PC 9/16" to 1" by 1/16" with 1/2" Shank	1	6*

*May Be Assorted For Volume Quantity.

CAT. NO.	SIZE	CAT. NO.	SIZE	CAT. NO.	SIZE	BOX QTY.	VOL. QTY.
----------	------	----------	------	----------	------	----------	-----------

NUMBER DRILLS (Orifice with Thumb Holders)

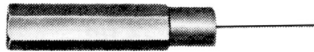

R275340 to R279400

R275340	19	R275400	40	R277500	61	1	3
R275342	20	R275500	41	R277600	62	1	3
R275344	21	R275600	42	R277700	63	1	3
R275346	22	R275700	43	R277800	64	1	3
R275348	23	R275800	44	R277900	65	1	3
R275350	24	R275900	45	R278000	66	1	3
R275352	25	R276000	46	R278100	67	1	3
R275354	26	R276100	47	R278200	68	1	3
R275356	27	R276200	48	R278300	69	1	3
R275358	28	R276300	49	R278400	70	1	3
R275360	29	R276400	50	R278500	71	1	3
R275362	30	R276500	51	R278600	72	1	3
R275364	31	R276600	52	R278700	73	1	3
R275366	32	R276700	53	R278800	74	1	3
R275368	33	R276800	54	R278900	75	1	3
R275370	34	R276900	55	R279000	76	1	3
R275372	35	R277000	56	R279100	77	1	3
R275374	36	R277100	57	R279200	78	1	3
R275376	37	R277200	58	R279300	79	1	3
R275378	38	R277300	59	R279400	80	1	3
R275380	39	R277400	60	R279520	Broach	1	3

CAT. NO.	DESCRIPTION	BOX QTY.	VOL. QTY.
----------	-------------	----------	-----------

NUMBER DRILL KITS

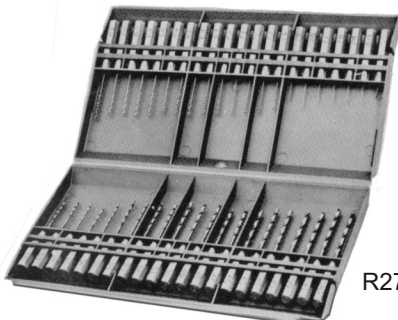

R279600

R279540	Kit contains #19 to #39 in Plastic box.	1	2
R279550	Kit contains #19 to #60 in Plastic box.	1	2
R279560	Kit contains #60 to #80 in Plastic box.	1	2
R279600	Kit contains #40 to #80 and Broach in Plastic box.	1	2

WOODBITS - IRWIN

CAT.
NO.

SIZE

BOX
QTY.

VOL.
QTY.

#2000 SPEEDBOR BITS



R280000 to R281600



R281700 - R281800

R280000			1/4"	(1)6	12*
R280100			5/16"	(1)6	12*
R280200			3/8"	(1)6	12*
R280300			7/16"	(1)6	12*
R280400			1/2"	(1)6	12*
R280500			9/16"	(1)6	12*
R280600			5/8"	(1)6	12*
R280700			11/16"	(1)6	12*
R280800			3/4"	(1)6	12*
R280900			13/16"	(1)6	12*
R281000			7/8"	(1)6	12*
R281100			15/16"	(1)6	12*
R281200			1"	(1)6	12*
R281300			1 1/8"	(1)3	12*
R281400			1 1/4"	(1)3	12*
R281500			1 3/8"	(1)3	12*
R281600			1 1/2"	(1)3	12*
R281700	88601	Old Style	12" Extension	(1)6	12*
R281800	88702	Old Style	6" Extension	(1)6	12*
R281810	90112	New Style	12"QC Extension	1	12*
R281815	90106	New Style	6"QC Extension	1	12*

*May Be Assorted For Volume Quantity.

R282000	88891	Display with 34 Bits and 4 Externsions		1	-
---------	-------	--	--	---	---

#2000 SPEEDBOR SETS













R282200	88886	6 Pieces 3/8", 1/2", 5/8", 3/4", 7/8" & 1"		1	4
R282300	88887	13 Pieces 1/4" through 1"		1	2



R282000

#2000-XL SPEEDBOR BIT (16" Overall Length)

R282600			3/8"	6	12
R282700			1/2"	6	12
R282800			5/8"	6	12
R282900			3/4"	6	12
R283000			7/8"	6	12
R283100			1"	6	12
R283200	90097	Display with 3 of each of above.		1	-
R283205			1 1/8"	1	6
R283210			1 1/4"	1	6
R283215			1 3/8"	1	6
R283220			1 1/2"	1	6

DRILL BITS		CAT. NO.	MFG. NO.	NO. OF HOLES	HOLE SIZE	SHANK SIZE	THICKNESS	BOX QTY.	VOL. QTY.
SELF STARTING MULTIPLE HOLE SIZE									
	1	R283700	1	13	1/8" to 1/2"	1/4"	1/8"	(1)5	5
	2	R283800	2	6	3/16" to 1/2"	1/4"	1/8"	(1)5	5
	3	R283900	3	9	1/4" to 3/4"	3/8"	1/8"	(1)5	5
	4	R283910	4	12	3/16" to 7/8"	3/8"	1/8"	(1)5	5
	5	R283920	5	10	1/4" to 1 3/8"	1/2"	1/8"	(1)5	5
SELF STARTING SINGLE HOLE SIZE									
	10	R284000	10	1	1/2"	1/4"	-	(1)5	5
	11	R284100	11	1	7/8"	3/8"	-	(1)5	5
	12	R284200	12	1	3/8"	1/4"	-	(1)5	5
	13	R284300	13	1	1 1/8"	1/2"	-	(1)5	5
	14	R284400	14	1	1 7/32"	1/2"	-	(1)5	5
HOLE ENLARGING BIT									
	20	R284500	20	8	9/16" to 1"	1/2"	1/8"	(1)5	5
	21	R284600	21	10	13/16" to 1 3/8"	1/2"	1/8"	(1)5	5

CAT. NO.	SIZE	LENGTH	BOX QTY.	VOL. QTY.
----------	------	--------	----------	-----------

BELL HANGER'S - FEELER BIT

- HAMMERED STEEL, ONE PIECE CONSTRUCTION.
- FISH HOLE IN TIP OF FLUTE.



R289510	1/4"	12"	1	6
R289512	5/16"	12"	1	6
R289514	3/8"	12"	1	6
R289516	1/2"	12"	1	6
R289518	1/4"	18"	1	6
R289520	5/16"	18"	1	6
R289522	3/8"	18"	1	6
R289524	1/2"	18"	1	6
R289526	1/4"	24"	1	6
R289528	5/16"	24"	1	6
R289530	3/8"	24"	1	6
R289532	1/2"	24"	1	6

(30"-42"-48"-72" Available)

HOLE SAWS AND ARBORS

CAT. NO.	DIAMETER	CUTTING DEPTH	USE ARBOR#	PIPE TAP SIZE	PIPE ENTRANCE	BOX QTY.	VOL. QTY.
----------	----------	---------------	------------	---------------	---------------	----------	-----------

HIGH SPEED STEEL HOLE SAWS - BI-METAL

4/6 Variable Tooth (Cuts through 2x4 in single pass)

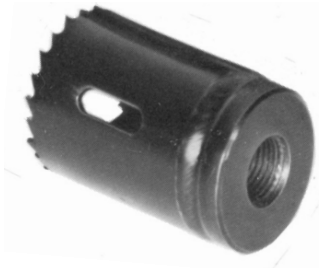

R290000	9/16"	1 3/4"				1	2
R290100	5/8"	1 3/4"				1	2
R290200	11/16"	1 3/4"				1	2
R290300	3/4"	1 3/4"	5514	1/2"	3/8"	1	2
R290400	13/16"	1 3/4"	or			1	2
R290500	7/8"	1 3/4"	5515	3/4"	1/2"	1	2
R290700	15/16"	1 3/4"	or			1	2
R290800	1"	1 3/4"	5518			1	2
R291000	1 1/16"	1 3/4"	or			1	2
R291100	1 1/8"	1 3/4"	5519	1"	3/4"	1	2
R291300	1 3/16"	1 3/4"				1	2

R291700	1 1/14"	1 3/4"				1	2
R291900	1 5/16"	1 3/4"	5516			1	2
R292000	1 3/8"	1 3/4"	or		1"	1	2
R292200	1 7/16"	1 3/4"	5520			1	2
R292300	1 1/2"	1 3/4"		1 1/4"		1	2
R292500	1 9/16"	1 3/4"				1	2
R292600	1 5/8"	1 3/4"				1	2
R292700	1 11/16"	1 3/4"				1	2
R292800	1 3/4"	1 3/4"		1 1/2"	1 1/4"	1	2
R293000	1 13/16"	1 3/4"				1	2
R293100	1 7/8"	1 3/4"				1	2
R293200	2"	1 3/4"			1 1/2"	1	2



R293400	2 1/16"	1 3/4"				1	2
R293500	2 1/8"	1 3/4"				1	2
R293600	2 1/4"	1 3/4"		2"		1	2
R293800	2 5/16"	1 3/4"				1	2
R293900	2 3/8"	1 3/4"				1	2
R294000	2 1/2"	1 3/4"	5545		2"	1	2
R294200	2 9/16"	1 3/4"	or			1	2
R294300	2 5/8"	1 3/4"	5546	2 1/2"		1	2
R294400	2 3/4"	1 3/4"	or			1	2
R294500	2 7/8"	1 3/4"	5573			1	2
R294600	3"	1 3/4"			2 1/2"	1	2
R294800	3 1/8"	1 3/4"				1	2

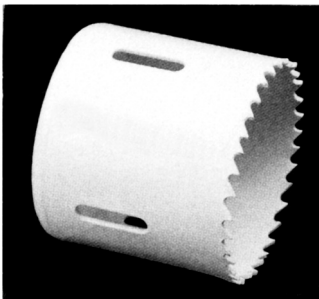

R294900	3 1/4"	1 3/4"		3"		1	2
R295000	3 3/8"	1 3/4"				1	2
R295200	3 1/2"	1 3/4"				1	2
R295300	3 5/8"	1 3/4"			3"	1	2
R295400	3 3/4"	1 3/4"		3 1/2"		1	2
R295500	3 7/8"	1 3/4"				1	2
R295600	4"	1 3/4"				1	2
R295700	4 1/8"	1 3/4"			3 1/2"	1	2
R295800	4 1/4"	1 3/4"		4"		1	2
R295900	4 3/8"	1 3/4"				1	2
R296000	4 1/2"	1 3/4"				1	2
R296100	4 3/4"	1 3/4"		4 1/2"	4"	1	2

R296200	5"	1 3/4"				1	2
R296300	5 1/2"	1 3/4"			5"	1	2
R296400	5 3/4"	1 3/4"				1	2
R296500	6"	1 3/4"				1	2

RICHARD SPECIALTY CO., INC.

HOLE SAWS AND ARBORS

	CAT. NO.	MFG. NO.	FITS HOLE SAWS	SHANK SIZE	CHUCK SIZE	REPLACEMENT DRILL SIZE	BOX QTY.	VOL. QTY.
R296600								
								
	R296600	5514	9/16"-1 3/16"	1/4 RD.	1/4"	8535	1	2
	R296700							
	R296700	5515	9/16"-1 3/16"	1/4 UNIVERSAL	1/4"	8534	1	2
								
	R296750	5518	9/16"-1 3/16"	7/16 HEX	1/2"	8535	1	2
	R296800							
	R296800	5519	9/16"-1 3/16"	3/8 HEX	3/8"	8534	1	2
	R296850							
	R296850	5516	1 1/4"-2"	1/4 UNIVERSAL	1/4"	8534	1	2
	R297100							
	R297100	5520	1 1/4"-2"	7/16 HEX	1/2"	8535	1	2
	R297200							
	R297200	5545	1 1/4"-6"	7/16 HEX Q.C.	1/2"	8535	1	2
	R297250							
	R297250	5546	1 1/4"-6"	3/8 HEX Q.C.	3/8"	8534	1	2
	R299300							
	R297300	5573	1 1/4"-6"	5/8 HEX Q.C.	3/4"	8535	1	2

	CAT. NO.	MFG. NO.	DESCRIPTION	BOX QTY.	VOL. QTY.
PILOT DRILLS AND EXTENSIONS					
	R297400	8534	3 1/4" Pilot Drill	1	10
	R297500	8535	1 1/2" Pilot Drill	1	10
	R297600	5500	12" Extension for 7/16" Shank Arbors	1	2

	CAT. NO.	SIZE	PIPE TAP SIZE	PIPE ENTRANCE SIZE	BOX QTY.	VOL. QTY.
--	----------	------	---------------	--------------------	----------	-----------

ONE-PIECE BI-METAL HOLE SAWS - WHITE

3/8" Hex Mandrel - 4/6 Variable Tooth - Can Be Used in 3/8" or Larger Drills.

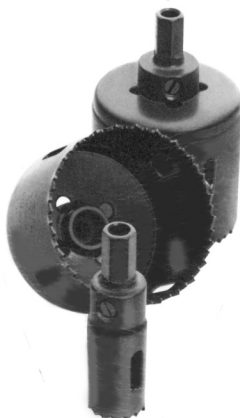

R298300	3/4"	1/2"	3/8"	1	2
R298500	7/8"	3/4"	1/2"	1	2
R298700	1"			1	2
R298900	1 1/8"	1"	3/4"	1	2
R299100	1 1/4"			1	2
R299300	1 3/8"		1"	1	2
R299500	1 1/2"	1 1/4"		1	2
R299700	1 5/8"			1	2
R299900	1 3/4"	1 1/2"	1 1/4"	1	2
R300100	1 7/8"			1	2
R300200	2"		1 1/2"	1	2
R300400	2 1/8"			1	2
R300500	2 1/4"	2"		1	2
R300700	2 3/8"			1	2
R300800	2 1/2"		2"	1	2

HOLE SAWS AND ARBORS

CAT. NO.	SIZE	PIPE TAP SIZE	PIPE ENTRANCE SIZE	BOX QTY.	VOL. QTY.
----------	------	---------------	--------------------	----------	-----------

ONE-PIECE BI-METAL HOLE SAWS - WHITE

3/8" Hex Mandrel - 4/6 Variable Tooth - Can Be Used in 3/8" or Larger Drills.



R301000	2 5/8"	1/2"		1	2
R301100	2 3/4"			1	2
R301200	2 7/8"			1	2
R301300	3"		2 1/2"	1	2
R301400	3 1/8"			1	2
R301500	3 1/4"	3"		1	2
R301600	3 3/8"			1	2
R301700	3 1/2"			1	2
R301800	3 5/8"		3"	1	2
R301900	3 3/4"	3 1/2"		1	2
R302000	3 7/8"			1	2
R302100	4"			1	2
R302105	4 1/8"		3 1/2"	1	2
R302110	4 1/4"	4"		1	2
R302115	4 3/8"			1	2
R302120	4 1/2"			1	2
R302125	4 3/4"	4 1/2"	4"	1	2
R302130	5"			1	2

TAPS AND DIES

CAT. NO.	SIZE	THREADS PER INCH	USE DRILL SIZE	BOX QTY.	VOL. QTY.
----------	------	------------------	----------------	----------	-----------

PIPE TAPS - CARBON STEEL RIGHT HAND

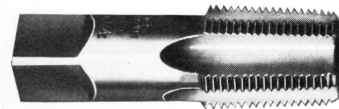

R303500	1/8" - 27NPT		11/32"	1	6*
R303600	1/4" - 18NPT		7/16"	1	6*
R303700	3/8" - 18NPT		37/64"	1	6*
R303800	1/2" - 14NPT		23/32"	1	6*
R303900	3/4" - 14NPT		59/64"	1	6*
R304000	1" - 11 1/2NPT		1 5/32"	1	6*
R304100	1 1/4" - 11 1/2NPT		1 1/2"	1	6*
R304200	1 1/2" - 11 1/2NPT		1 47/64"	1	6*
R304300	2" - 11 1/2NPT		2 7/32"	1	6*
R304400	2 1/2" - 8NPT			1	6*
R304500	3" - 8NPT			1	6*

*May Be Assorted For Volume Quantity.

CAT. NO.	MFG. NO.	SIZE	BOX QTY.	VOL. QTY.
----------	----------	------	----------	-----------

MACHINE SCREW TAPS - PLUG STYLE

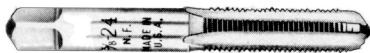

R304600	WC11	6-32NC	5	10
R304700	WC11	8-32NC	5	10
R304800	WC11	10-24NC	5	10
R304900	WC11	10-32NF	5	10
R305000	WC11	12-24NC	5	10
R305100	WC10	1/4-20NC	5	10
R305200	WC10	5/16-18NC	5	10
R305300	WC10	3/8-16NC	5	10
R305400	WC10	7/16-14NC	5	10
R305500	WC10	1/2-13NC	5	10

RICHARD SPECIALTY CO., INC.

TAPS AND DIES



TAP AND DRILL COMBINATION

CAT. NO.	TAP SIZE	DRILL SIZE	BOX QTY.	VOL. QTY.
R305625	1/4 - 20NC	#7	1	5
R305630	5/16 - 18NC	17/64	1	5
R305635	3/8 - 16NC	#0	1	5

CAT. NO.	MFG. NO.	CAPACITY TAPS	BOX QTY.	VOL. QTY.
----------	----------	---------------	----------	-----------



TAP WRENCHES

R305900	TW1E	No. 0 to No. 12	1	5
R306000	TW1 1/2E	No. 12 to 5/16"	1	5
R306100	TW2E	1/4" to 1/2"	1	5

CAT. NO.	MFG. NO.	DESCRIPTION	BOX QTY.	VOL. QTY.
----------	----------	-------------	----------	-----------

MACHINE SCREW TAP SETS - PLUG STYLE

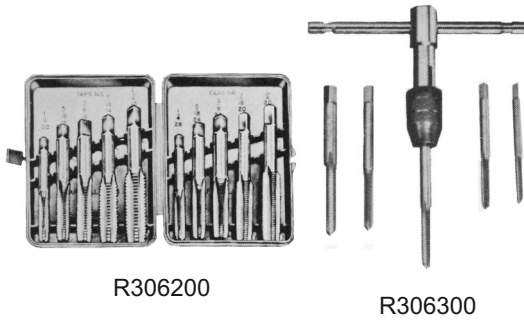

R306200	WC-37	One each tap 1/4-20, 1/4-28, 5/16-18, 5/16-24, 3/8-16, 3/8-24, 7/16-14, 7/16-20, 1/2-13, 1/2-20	1	3
R306300	85020	Six piece set contains five popular tap sizes 6/32", 8/32", 10-32", 10-24, 1/4"-20 and "T" handle with knurled chuck packed in plastic pouch.	1	5

CAT. NO.	SIZE	SIZE SQUARE	THICKNESS	BOX QTY.	VOL. QTY.
----------	------	-------------	-----------	----------	-----------

SQUARE PIPE DIES

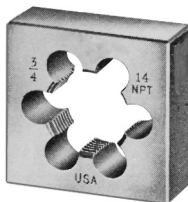

R307000	1/8"	2 1/2"	3/4"	1	2
R307100	1/4"	2 1/2"	3/4"	1	2
R307200	3/8"	2 1/2"	3/4"	1	2
R307300	1/2"	2 1/2"	3/4"	1	2
R307400	3/4"	2 1/2"	3/4"	1	2
R307500	1"	2 1/2"	3/4"	1	2
R307600	1 1/4"	4"	1"	1	2
R307700	1 1/2"	4"	1"	1	2
R307800	2"	4"	1"	1	2

PLUMB BOBS	CAT. NO.	WEIGHT	DESCRIPTION	BOX QTY.	VOL. QTY.
-------------------	----------	--------	-------------	----------	-----------

HEX PLUMB BOBS

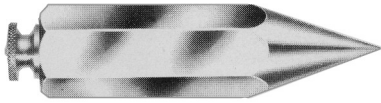

R308000	3oz.	Hex	(1)5	10
R308100	5oz.	Hex	(1)5	10
R308200	8oz.	Hex	(1)5	10
R308300	12oz.	Hex	(1)5	10

CHALK LINE REELS	CAT. NO.	MFG. NO.	FEET LINE	BOX QTY.	VOL. QTY.
-------------------------	----------	----------	-----------	----------	-----------



R308600
R308700



R308710

R308600	63950	50'	1	6
R308700	64110	100'	1	6
R308710	64310	100'	1	6

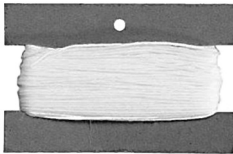

R308800
R308900

CHALK LINE REPLACEMENT LINE

R308800	64550	50'	(1)6	12
R308900	64610	100'	(1)6	12

	CAT. NO.	MFG. NO.	COLOR	CONTAINER WEIGHT	BOX QTY.	VOL. QTY.
--	----------	----------	-------	------------------	----------	-----------

CHALK LINE REEL - CHALK REFILLS



R309000	64901	Blue	8oz.	6	12
R309100	64902	Red	8oz.	6	12
R309200	64903	Yellow	8oz.	6	12
R309300	64904	White	8oz.	6	12
R309310	64905	Orange	8oz.	6	12

RICHARD SPECIALTY CO., INC.

ABRASIVE CLOTH

CAT. NO.	LENGTH	WIDTH	DESCRIPTION	BOX QTY.	VOL. QTY.
----------	--------	-------	-------------	----------	-----------



WET CUT CLOTH (Original 100% Waterproof Sand Cloth) (Blue-Green Backing)

R309700	5 yrd.	1 1/2"	120grit	(1)24	48*
R309800	10 yrd.	1 1/2"	120grit	(1)24	48*
R309900	25 yrd.	1 1/2"	120grit	(1)12	48*



EMERY CLOTH (Blue Backing)

R310000	5 yrd.	1 1/2"	120grit	(1)24	48*
R310100	10 yrd.	1 1/2"	120grit	(1)24	48*
R310200	25 yrd.	1 1/2"	120grit	(1)12	48*



WHITE CLOTH (White Backing)

R310500	10 yrd.	1 /12"	120grit	(1)24	48*
R310600	25 yrd.	1 /12"	120grit	(1)12	48*



BROWN CLOTH (Brown Backing)

R310900	10 yrd.	1 1/2"	120grit	(1)24	48*
R311000	25 yrd.	1 1/2"	120grit	(1)12	48*



SUPER RED (Red Backing)

R311300	10 yrd.	1 1/2"	120grit	(1)24	48*
R311400	25 yrd.	1 1/2"	120grit	(1)12	48*

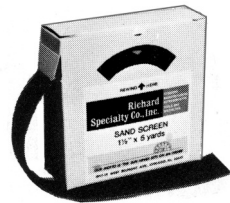

SAND SCREEN ("Grit Cloth")

R311600	5 yrd.	1 1/2"	180grit	(1)24	48*
R311700	10 yrd.	1 1/2"	180grit	(1)24	48*
R311800	25 yrd.	1 1/2"	180grit	(1)12	48*

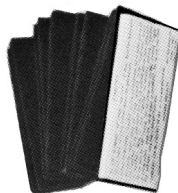

SAND SCREEN FLEXCUT (Small Holes)

R311840	5 yrd.	1 1/2"	180grit	(1)24	48*
R311850	10 yrd.	1 1/2"	180grit	(1)24	48*
R311860	25 yrd.	1 1/2"	180grit	(1)12	48*

SAND PADS

			COLOR	PIECES PER PKG.		
R311900	6"	2"	Black	10	(1)24	48*
R312000	6"	4"	Maroon	10	(1)14	48*
R312200	9"	6"	Green	5	(1)10	48*

*May Be Assorted For Volume Quantity.

COPPER SANDING GLOVE with SCOTCH-BRITE

R312240 Sanding Glove	1PR.	6PR.
-----------------------	------	------

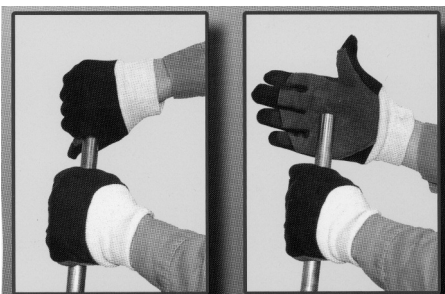

TWIN GRIP REPLACEMENT HANDLE

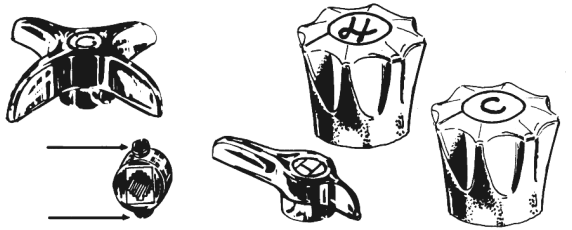

CAT. NO.	MFG. NO.	DESCRIPTION	BOX QTY.	VOL. QTY.
----------	----------	-------------	----------	-----------

TWIN GRIP REPLACEMENT HANDLE

R312400	VP-100	Cross type H&C index (Chrome)	1	12*
R312600	VP-200	Lever type H&C index (Chrome)	1	12*
R312800	D-300set	Crystal H&C index (Tub/Lav.)	1	12*

*May Be Assorted For Volume Quantity.

TROUBLE LIGHTS & POWER CORDS

All trouble lights and power cords are UL listed.

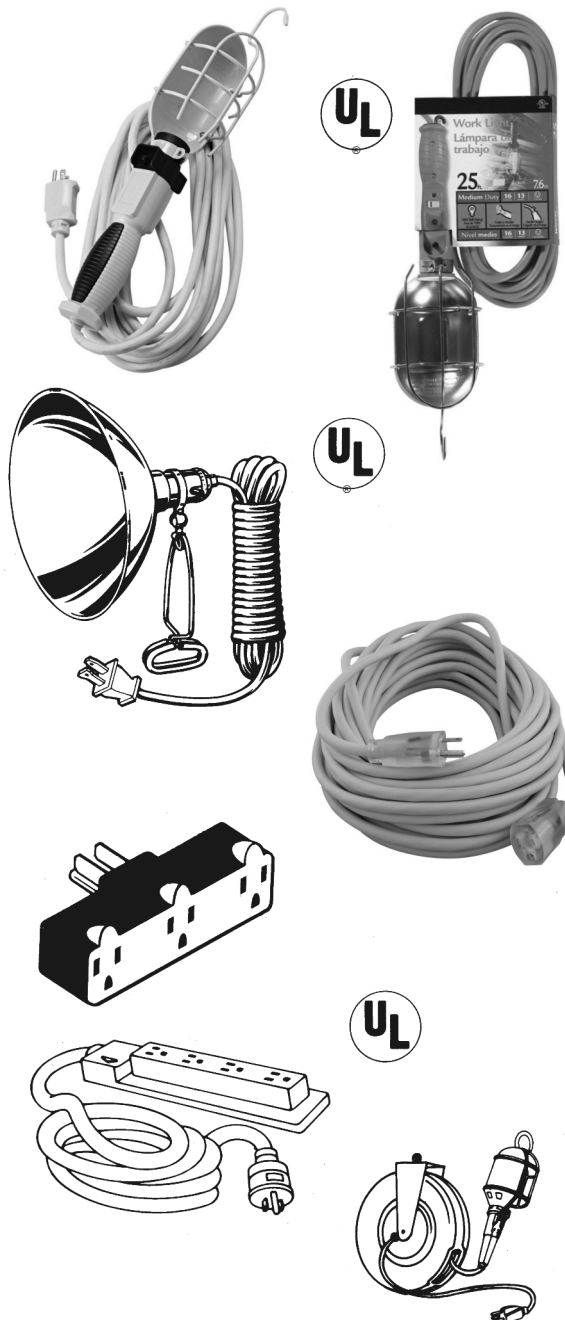

TROUBLE LIGHTS

POLAR SOLAR® TOTAL FLEXIBILITY TO -70°C

R313000	25ft. 16/3	Yellow w/Metal Guard	1	6
R313005	50ft. 16/3	Yellow w/Metal Guard	1	6
R313015	25ft. 14/3	Yellow w/Metal Guard	1	6
R313020	50ft. 14/3	Yellow w/Metal Guard	1	6

TROUBLE LIGHTS

R313200	25ft. 16/3	Vinyl-Orange-Rd. w/Metal Guard	1	6
R313300	50ft. 16/3	Vinyl-Orange-Rd. w/Metal Guard	1	6
R313500	25ft. 16/3	Vinyl-Orange-Rd. w/Metal Guard	1	6
R313600	50ft. 16/3	Vinyl-Orange-Rd. w/Metal Guard	1	6

REFLECTOR LIGHT - HEAVY DUTY

R313900	15ft. 18/2	Black 8 1/2" Reflector	1	12
---------	------------	------------------------	---	----

POWER CORDS

R314100	50ft. 12/3	Yellow-Round Lighted End	1	3
R314200	100ft. 12/3	Yellow-Round Lighted End	1	3

POLAR SOLAR® TOTAL FLEXIBILITY TO -70°C

R314405	50ft. 14/3	Round Yellow	1	6
R314410	100ft. 14/3	Round Yellow	1	6
R314415	50ft. 12/3	Round Yellow	1	6
R314420	100ft. 12/3	Round Yellow	1	6

TRI TAP ADAPTER

R314430	Orange	1	20
---------	--------	---	----

QUADNECTOR POLAR SOLAR®



TOTAL FLEXIBILITY TO -70°C

R314600	25ft. 12/3	Round Yellow	6	12
R314700	50ft. 12/3	Round Yellow	4	8
R314800	100ft. 12/3	Round Yellow	4	8

REEL LIGHT

R315000	50ft. 18/3	w/Metal Guard	4	8
---------	------------	---------------	---	---

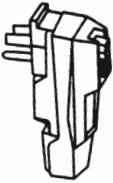
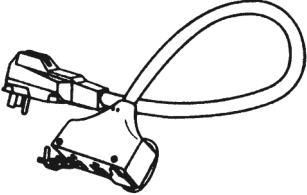
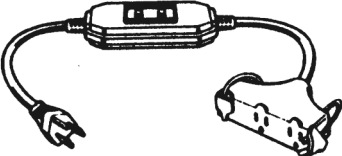
RICHARD SPECIALTY CO., INC.

GFCIs		CAT. NO.	SIZE	DESCRIPTION	BOX QTY.	VOL. QTY.	
	USER ATTACHABLE GFCI						
		R315135			10	20	
		GFCI EXTENSION CORD WITH MOLDED TRI-SOURCE					
			R315140	25ft.	12/3	6	12
		R315145	50ft.	12/3	6	12	
	R315150	100ft.	12/3	4	8		
	TRI-SOURCE IN-LINE GFCI 20 AMP						
		R315160	30"	12/3	6	12	
	QUAD BOX - GFCI 20 AMP WITH HANDLE						
		R315170	6ft.	12/3	2	4	

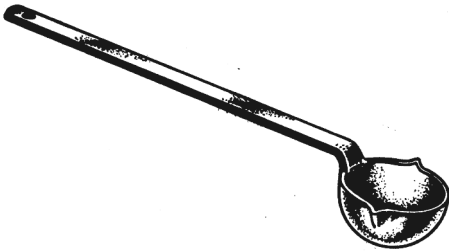
LADLES & LEAD POTS		CAT. NO.	SIZE	APPROX. LEAD CAPACITY (LBS.)	BOX QTY.	VOL. QTY.
	STEEL LADLES					
		R315500	2 1/2"	1 1/4	1	6
		R315600	3"	2 1/4	1	6
		R315700	3 1/2"	3	1	6
		R315800	4"	4 1/4	1	6
		R315900	5"	10	1	3
		R316000	6"	14	1	3
		R316100	7"	21	1	2
		R316200	8"	27	1	2
		R316300	9"	40	1	2
	R316400	10"	50	1	2	

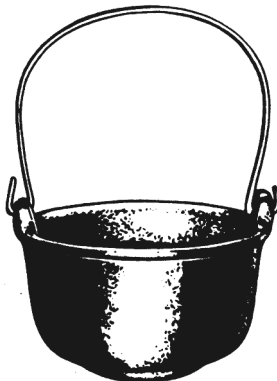

CAST IRON LEAD POTS

R316800	5"	15	1	6
R316900	6"	23	1	6
R317100*	8"	65	1	6
R317200	10"	110	1	2

*With Pour Lip

NIPPLE BOXES

CAT. NO.	MFG. NO.	SIZE	NIPPLE SIZE	NIPPLES HELD	BOX QTY.	VOL. QTY.
----------	----------	------	-------------	--------------	----------	-----------

R317500 -
R318250

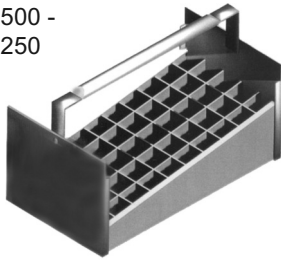

NIPPLE BOXES (Comes with Swinger Handle)

PARTITIONED

R317500	E-50-R	1/2"	close through 6"	77	1	20*
R317600	E-51-R	3/4"	close through 6"	66	1	20*
R317700	E-52-R	1"	close through 6"	50	1	20*
R317800	E-53-R	1 1/4"	close through 6"	40	1	20*
R317900	E-54-R	1 1/2"	close through 6"	30	1	20*
R318000	E-55-R	2"	close through 6"	27	1	20*
R318100	E-56-R	1/2"	6"through 12"	77	1	20*
R318200	E-57-R	3/4"	6"through 12"	66	1	20*

COMBO NIPPLE BOX

R318250	E-62-R	1/2" & 3/4"	close through 6" (39-1/2" & 33-3/4")	72	1	20*
---------	--------	-------------	---	----	---	-----

*May Be Assorted For Volume Quantity.

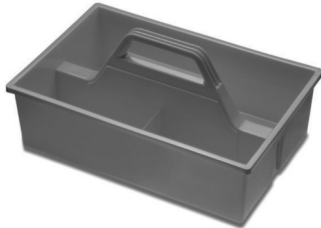

R318340

TOTE TRAY

R318340	PT005	High Density Polyethylene			1	6
---------	-------	---------------------------	--	--	---	---

BUCKET ORGANIZER (with Three Trays)

R318345	BO111	High Impact Plastic, Heavy Duty Handle			1	6
---------	-------	--	--	--	---	---



R318345

BUCKET LID

R318346	BL111	Rugged and Durable, Water Resistant			1	6
---------	-------	-------------------------------------	--	--	---	---



R318348

PARTS TRAY (for Bucket Organizer)

R318347	BOT01	Separated Sections for Sorting			1	6
---------	-------	--------------------------------	--	--	---	---

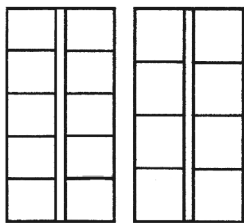

R318410

R318415

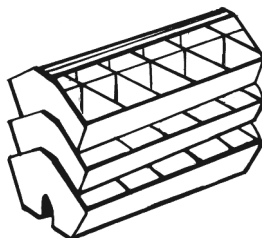

22 POCKET BUCKET APRON

R318348	BA20	Fits All 3.5 & 5 gal Buckets. Secures Permanently with Attachment Accessories			1	6
---------	------	---	--	--	---	---

GALVANIZED FITTING TRAYS

R318410	Fitting & Nipple Tote Tray (Stackable) - Galvanized	10 Compartments - AMERICAN MADE			1	6
---------	---	---------------------------------	--	--	---	---

R318415	Fitting & Nipple Tray (Stackable) - Galvanized	8 Compartment - AMERICAN MADE			1	6
---------	--	-------------------------------	--	--	---	---

R318440	Fitting & Nipple Tray (Baked Epoxy Finish)	8 Compartments Folding Handle	20" x 10" x 5"		1	6
---------	--	-------------------------------	----------------	--	---	---

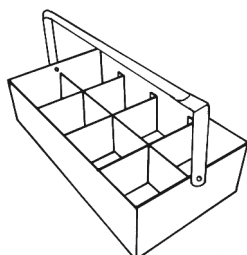

R318440

R318450



R318450	TB-52 Totebag	(Size 8"W x 16"L x 11"D)			1	6
---------	---------------	--------------------------	--	--	---	---

RICHARD SPECIALTY CO., INC.

FLASHLIGHTS	CAT. NO.	MFG. NO.	DESCRIPTION	BOX QTY.	VOL. QTY.
	R319000	2618	2-D Cell Plastic Unbreakable	(1)12	24
	R319100	00901	6 volt Heavy Duty w/Krypton bulb Plastic / It Floats	1	12

LED FLASHLIGHT & WORKLIGHTS	CAT. NO.	MFG. NO.	DESCRIPTION	BOX QTY.	VOL. QTY.
--	----------	----------	-------------	----------	-----------

	R319350		POCKET LED LIGHTSTICK		
	R319350	PCLED6	150 Lumens, COB LEDs, 2x Stronger Magnetic Base, Up to 7 Hour Run Time, Pocket Clip, Operates on 3 AAA Batteries, Weather Resistant Button	1	6
	R319360				
R319360	RT-2LT		24 LED Rotating Magnetic Work Light	1	6
	R319365				
R319365	RT-2LTCH		24 LED Rechargeable Rotating Magnetic Work Light - 65 Lumens	1	6
	R319370				
R319370	RT-6SMD		6 SMD LED Rotating Magnetic Work Light - 300 Lumens	1	6
	R319400				
R319400			15 LED Work Light + 3 LED Flashlight Includes Wall and Car Charger	1	6
	R319405				
R319405			Telescoping LED Flashlight + Pick Up Tool Extends Up to 20", 3 Super Bright LEDs, 2lb. Front Magnet, 5lb. Rear Magnet	1	12

BULBS & BATTERIES



R320700

CAT. NO.	MFG. NO.	DESCRIPTION	BOX QTY.	VOL. QTY.
BULBS				
R319700	PR-2	Replacement Bulbs 2 per card	(1)20	-
R319800	PR-13	Replacement Bulbs 2 per card	(1)20	-
R319900	PR-2K	Krypton Bulb	(1)20	-
BATTERIES				
R320700	7520	Alkaline D	24	48

LOG LIGHTERS

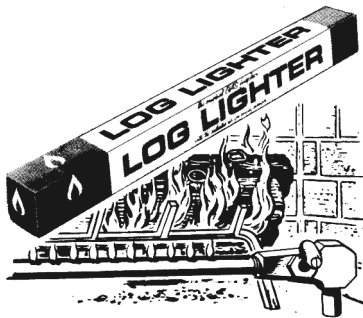

R321000 - R321700

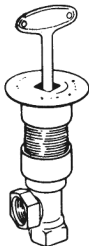

R322100 - R322250



R322350 - R322360



R322410 - R322510



R323600 - R323755

CAT. NO.	DESCRIPTION	BOX QTY.	VOL. QTY.
LOG LIGHTERS - DANTE			
R321000	Combo Pak - Straight Natural Gas - Chrome Floor Plate	(1)12	36*
R321100	Combo Pak - Straight Natural Gas - Brass Floor Plate	(1)12	36*
R321200	Combo Pak - Straight L.P. Gas - Chrome Floor Plate	(1)12	36*
R321300	Combo Pak - Angle Natural Gas - Chrome Floor Plate	(1)12	36*
R321400	Combo Pak - Angle Natural Gas - Brass Floor Plate	(1)12	36*
R321500	Combo Pak - Angle L.P. Gas - Chrome Floor Plate	(1)12	36*
R321600	Combo Pak - Model T Natural Gas - Chrome Floor Plate	(1)12	36*
R321700	Combo Pak - Model T L.P. Gas - Chrome Floor Plate	(1)12	36*

* May Be Assorted For Volume Quantity

GAS VALVES - DANTE AGA CERTIFIED

R322100	Gas Valve - Straight - Chrome	BTU Rating 98,000	(1)	12*
R322150	Gas Valve - Straight - Brass	BTU Rating 98,000	(1)	12*
R322200	Gas Valve - Angle - Chrome	BTU Rating 158,000	(1)	12*
R322250	Gas Valve - Angle - Brass	BTU Rating 158,000	(1)	12*

*May Be Assorted For Volume Quantity.

3/4" BALL VALVES

R322350	3/4" - Ball Valve Straight Only	1	12*
R322355	3/4" - Ball Valve "S" 3" Chrome Key & Floor Plate	1	12*
R322360	3/4" - Ball Valve "S" 3" Brass Key & Floor Plate	1	12*

STEM EXTENDERS

R322410	Stem Extender 12"	1	6
R322510	Stem Extender 18"	1	6

KEYS

R322600	Key 3"	For 1/4" & 5/16" socket - Chrome	1	6
R322605	Key 3"	For 1/4" & 5/16" socket - Brass	1	6
R322710	Key 8"	For 1/4" & 5/16" socket - Chrome	1	6
R322715	Key 8"	For 1/4" & 5/16" socket - Brass	1	6
R322730	Keys 12"	For 1/4" & 5/16" socket - Chrome	1	6
R322735	Keys 12"	For 1/4" & 5/16" socket - Brass	1	6
R322750	Keys 18"	For 1/4" & 5/16" socket - Chrome	1	6
R322755	Keys 18"	For 1/4" & 5/16" socket - Brass	1	6

RICHARD SPECIALTY CO., INC.

LOG LIGHTERS



R322800 - R322950



R323010 -
R323060



R323080



R323100 -
R323350



R323500



R323500 - R323705



R323800 -
R323910



R323910



R323915

BURNER PIPES

Full Size Fireplace
Pipe Only - Black

CAT. NO.	DESCRIPTION	BOX QTY.	VOL QTY.
R322800	17"	1	6
R322900	12"	1	6
R322910	24"	1	6
R322920	30"	1	6
R322925	36"	1	6
R322930	42"	1	6

Created for Outdoor Fire Pits
Stainless Steel

CAT. NO.	DESCRIPTION	BOX QTY.	VOL QTY.
R322935	17"	1	6
R322940	24"	1	6
R322945	30"	1	6
R322950	36"	1	6

FLOOR PLATES

CAT. NO.	DESCRIPTION	BOX QTY.	VOL QTY.
R323010	Floor Plate - Chrome - Dante	1	6
R323060	Floor Plate - Brass - Dante	1	6
R323080	12" Adjustable Floor Plate Extension	1	6

MIXING CHAMBERS

CAT. NO.	DESCRIPTION	BOX QTY.	VOL QTY.
R323100	Mixing Chamber - Angle - N. Gas	1	6
R323150	Mixing Chamber - Angle - L.P. Gas	1	6
R323200	Mixing Chamber - Straight - N. Gas	1	6
R323250	Mixing Chamber - Straight - L.P. Gas	1	6
R323300	Mixing Chamber - Model T - N. Gas	1	6
R323350	Mixing Chamber - Model T - L.P. Gas	1	6

LOG LIGHTERS ONLY

CAT. NO.	DESCRIPTION	BOX QTY.	VOL QTY.
R323500	Log Lighter Only - Universal NG	1	12
R323505	Log Lighter Only - L.P. Gas - Universal	1	6
R323700	Log Lighter Only - "T"	1	12
R323705	Log Lighter Only - "T" - L.P. Gas	1	6

Also Available 24", 30", 36" & 42" Log Lighters
Pricing On Application

WHISTLE-FREE FLEX HOSES

Gas Connector Hose with Fittings

1/2" MIP x 1/2" FIP (1/2" ID)

CAT. NO.	DESCRIPTION	BOX QTY.	VOL QTY.
R323800	12" SS	1	6
R323805	16" SS	1	6
R323810	18" SS	1	6
R323815	24" SS	1	6
R323820	30" SS	1	6
R323825	34" SS	1	6
R323830	36" SS	1	6
R323835	48" SS	1	6

1/2" MIP x 1/2" FIP (3/8" ID)

CAT. NO.	DESCRIPTION	BOX QTY.	VOL QTY.
R323840	12" SS	1	6
R323845	16" SS	1	6
R323850	18" SS	1	6
R323855	22" SS	1	6
R323860	24" SS	1	6
R323865	28" SS	1	6
R323870	30" SS	1	6
R323875	34" SS	1	6
R323880	36" SS	1	6
R323885	46" SS	1	6
R323890	48" SS	1	6

3/4" MIP x 1/2" FIP (3/4" ID)

CAT. NO.	DESCRIPTION	BOX QTY.	VOL QTY.
R323900	24" SS	1	6
R323905	36" SS	1	6
R323910	48" SS	1	6

FITTINGS

CAT. NO.	DESCRIPTION	BOX QTY.	VOL QTY.
R323910	1/2" Flare X 1/2" MIP Steel Fitting	1	6
R323915	1/2" Flare X 1/2" FIP Steel Fitting	1	6

*Black Hose Available Upon Request.

SUMP PUMP CHECK VALVES

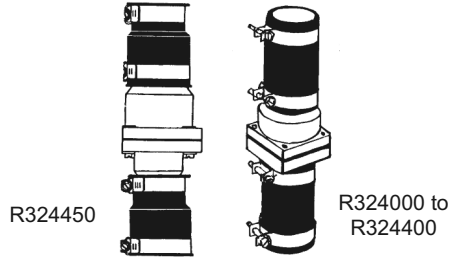

R324450

R324000 to R324400

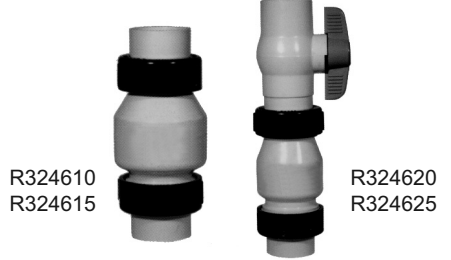

R324610
R324615

R324620
R324625

CHECK VALVES

CAT. NO.	MFG. NO.	SIZE-UPS	BODY	BOX QTY.	VOL. QTY.
R324000	125-P	1 1/4"	Plastic	1	24*
R324100	150-P	1 1/2"	Plastic	1	24*
R324200	200-P	2"	Plastic	1	24*
R324300	300	3"	Cast Iron	1	24*
R324400	3-in-1	1 1/4" & 1 1/2" IPS, 1 1/2" Copper	Plastic	1	24*
R324450	3-in-1 (SUPER)	1 1/4" & 1 1/2" IPS, 1 1/2" Copper	Plastic	1	24*
R324505	#1115	1 1/4", 1 1/2 IPS & 1 1/2 Copper	Plastic	1	24*
R324510	#1116	2" IPS		1	24*

*May Be Assorted For Volume Quantity.

R324610		1 1/2" PVC True Union Check Valve		1	12
R324615		2" PVC True Union Check Valve		1	12

TRUE UNION BALL VALVE CHECK VALVE COMBINATION

R324620		1 1/2" Combination		1	12
R324625		2" Combination		1	12

TOOL BOXES



METAL TOOL BOXES

CAT. NO.	MFG. NO.	WIDTH	DEPTH	HEIGHT	BOX QTY.	VOL. QTY.
R325600	9975	20"	8 1/2"	9 1/2"	1	2
R325800	9954	15"	6"	6 1/2"	1	2
R326000	9977	19"	7"	7 1/2"	1	2
R326200	9971	19 3/4"	7"	8"	1	2
R326300	9969	24"	9 1/2"	9 1/2"	1	2
R326400	9951	18"	10 1/8"	12 3/4"	1	2

PLASTIC TOOL BOXES

R326720	9901	20"	9 3/4"	10 1/2"	1	2
R326730	9902	26"	9 3/4"	10 1/2"	1	2
R326740	75605	Lock 'N Load Heavy Duty Dry Box			1	10
R326750	75630	Lock 'N Go Heavy Duty Tough Box			1	4

RICHARD SPECIALTY CO., INC.

1/2" RECIPG. BLADES

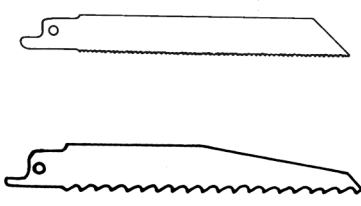

CAT. NO.	MFG. NO.	TEETH PER INCH	LENGTH	BLADES PER PKG.	BOX QTY.	VOL. QTY.
ULTRA-LIFE BI-METAL BLADES (White)						
R332020	AG-310	10	6"	5	1-PK.	25PK.*
R332025	AG-314	14	6"	5	1-PK.	25PK.*
R332030	AG-318	18	6"	5	1-PK.	25PK.*
R332035	AG-324	24	6"	5	1-PK.	25PK.*
R332040	AG-606	6	6"	5	1-PK.	25PK.*
R332045	AG-608	6	6"	5	1-PK.	25PK.*
R332050	AG-610	10	6"	5	1-PK.	25PK.*
R332055	AG-1208	6	12"	5	1-PK.	25PK.*
R332060	AG-1210	10-14	12"	5	1-PK.	25PK.*

*May Be Assorted For Volume Quantity.

JOINT RUNNERS-FIBRE GLASS

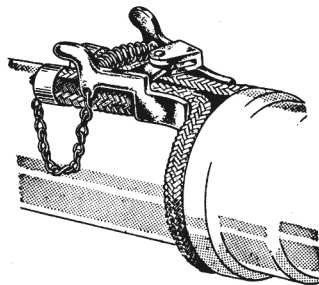

FIBRE GLASS JOINT RUNNERS

CAT. NO.	MFG. NO.	PIPE SIZE	ROPE SIZE	BOX QTY.	VOL. QTY.
R336700	1	2" thru 4"	3/4" Rd.	1	12
R336800	2	2" thru 6"	3/4" Rd.	1	12
R336900	3	6" thru 10"	3/4" Rd.	1	6
R337000	4	10" thru 14"	3/4" Rd.	1	6
R337100	5	16" thru 20"	1 1/8" Rd.	1	2
R337200	6	24"	1 1/8" Rd.	1	2
R337300	7	30"	1 1/8" Rd.	1	2
R337305	8	36"	1 1/8" Rd.	1	2
R337310	9	42"	1 1/8" Rd.	1	2
R337315	10	48"	1 1/8" Rd.	1	2

JOINT RUNNERS-RUBBER

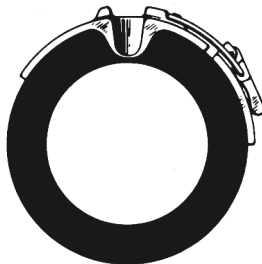

RUBBER RUNNER

CAT. NO.	MFG. NO.	PIPE SIZE	BOX QTY.	VOL. QTY.
R337500		2"	1	12*
R337700		3"	1	12*
R337900		4"	1	12*
R338100		6"	1	12*

*May Be Assorted For Volume Quantity.

TEST GAUGES, PUMPS, MISCELLANEOUS

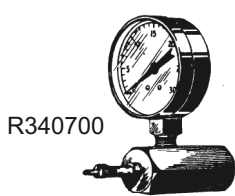

PORTABLE GAS DETECTOR (Battery Operated)

R340630	Detects Natural Gas, Methane, Propane, Hydrogen & Butane. Audible/Visual Alarm. Sensitivity 5000 PPM Methane & 2000 PPM Propane.	1	6
---------	--	---	---

GAS TEST GAUGE

R340700	0-30 PSI, 2" Dia.	1	6
R340705	0-60 PSI, 2" Dia.	1	6
R340710	0-100 PSI, 2" Dia.	1	6

SNIFTER VALVES

R340800	1/8"	1	12
R340810	1/4"	1	12

WATER TEST GAUGE

R340900	0-300 PSI, 2 1/2" Dia.	1	6
R340950	0-300 PSI, 2 1/2" Dia. w/Reset Drag Pointer	1	6

R340800 to R340810

R340900

R340950

TEST GAUGES, PUMPS, MISCELLANEOUS

CAT. NO.

SIZE

BOX VOL. QTY. QTY.

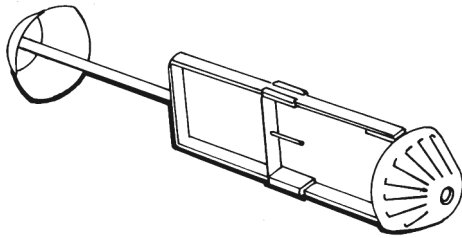

STUVEL FLUSH VALVE RESEATER TOOL

R341900	Reseater Tool	1	2
---------	---------------	---	---

FLEXIBLE PACKING TOOLS

CAT. NO.

MFG. NO.

LENGTH

DIAMETER SCREW BIT

BOX VOL. QTY. QTY.

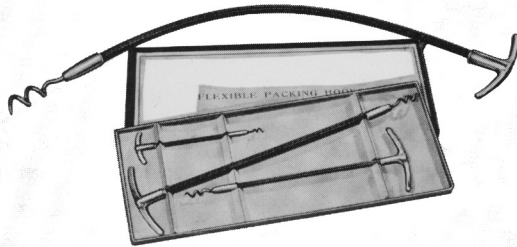

REMOVES PACKING FROM STUFFING BOXES

R341950	0	7"	11/64"	1	12*
R342000	1	6 1/4"	1/4"	1	12*
R342100	2	10 5/8"	5/16"	1	12*
R342200	3	15"	3/8"	1	12*
R342300	3-22	22"	3/8"	1	12*
R342400	3-30	30"	3/8"	1	12*
R342500	4	18"	1/2"	1	12*
R342600	5	22"	5/8"	1	12*
R342700	Set of #1, #2, #3			1	12*
R342750	Set of all 8 hooks			1	12*

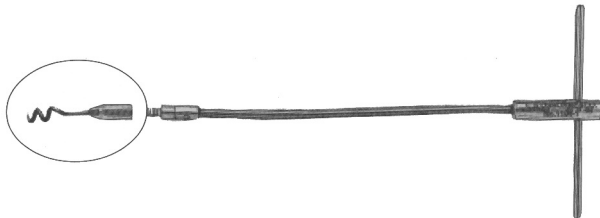

REFLEXIBLE PACKING TOOLS WITH REPLACEABLE-TIP

R342760	1	7 3/4"	1/4"	1	12*
R342765	2	10 3/4"	5/16"	1	12*
R342770	3	14 3/4"	3/8"	1	12*
R342775	Set of #1, #2, #3			1	12*
Replacement tips for above					
R342780	1c For R342760			1	12*
R342785	2c For R342765			1	12*
R342790	3c For R342770			1	12*

* May Be Assorted For Volume Quantity.

TUBE CUTTERS

CAT. NO.

MFG. NO.

SIZE

BOX VOL. QTY. QTY.

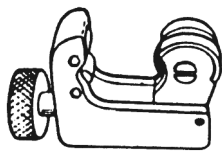

R342900

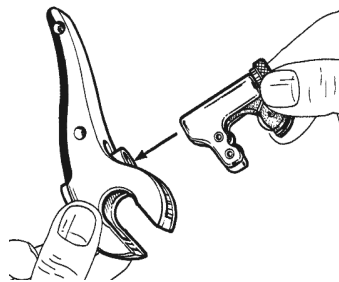

R343010 & R343020

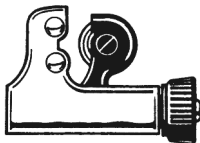

R343000 & R343100



R343050







R343200

TUBE-CUTTERS METAL TUBING

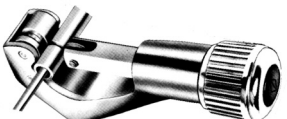
R342900	Mini Tube Cutter-Imported	1/8"-3/4" O.D.	1	6
R343000	TC-1050	1/8"-5/8" O.D.	1	6
R343010	TC-1050 RH	1/8"-5/8" O.D.	1	6
R343020	TC-1051 Handle Only		1	6
R343050	7.0402 Imported	1/8"-7/8" O.D.	1	6
R343060	7.0017	Wheel for R343050	1	6
R343100	TC-2050	3/16"-7/8" O.D.	1	6
R343200	174-F	3/8"-1 1/8" O.D.	1	6

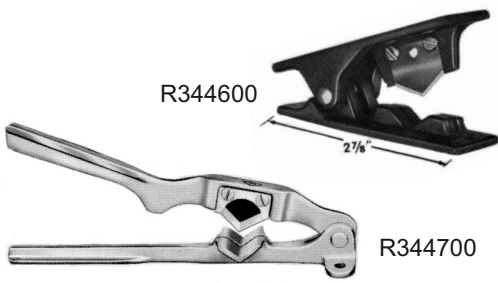
TUBE CUTTERS		CAT. NO.	MFG. NO.	SIZE	BOX QTY.	VOL. QTY.
TUBE-CUTTERS METAL TUBING						
		R343300	227-FA	1/8"-3/4" O.D.	1	6
R343400	R343300	R343400	TC-1000	1/8"-1 1/8" O.D.	1	6
		R343450	Imported	1/8"-1 1/8" O.D.	1	6
R343500	R343450	R343500	312-FC	1/4"-1 5/8" O.D.	1	6
		R343600	206-FB	3/8"-2 5/8" O.D.	1	3
R343700	R343600	R343700	406-FA	2"-4 1/8" O.D.	1	2
		R343800	RC-375	1/8"-3/8"	1	12*
R343810	R343800	R343805	RC-375-7	Wheels	1	12*
		R343810	RC-1125	5/16"-1 1/8"	1	12*
R343830 and R343835	R343820	R343820	RC-1125-7	Wheels for RC-1125	1	12*
		*May Be Assorted For Volume Quantity.				
RATCHET MOTION TUBING CUTTER-IMPORT						
		R343830	TCR-100	1/4"-7/8"	1	6
		R343835	TC 220-1	Wheel for R343830	1	6
ROTO CUT FOR COPPER AND CPVC						
		R343900- R343310		1/2" Roto Cut	1	6*
				3/4" Roto Cut	1	6*
				1" Roto Cut	1	6*
				Wheel for 1/2", 3/4" & 1" Roto Cut	1	6*
*May Be Assorted For Volume Quantity.						
		R343950		1/2"	1	6*
		R343955		3/4"	1	6*
				Replacement cutting wheel for TC-50 and TC-75	1	6*
TUBE CUTTER-SLICE STYLE						
		R343950	TC-50	1/2"	1	6*
		R343955	TC-75	3/4"	1	6*
		R343960	TC50-1		1	6*

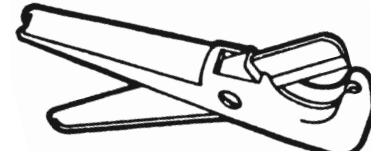
TUBE CONSTRICTOR		CAT. NO.	MFG. NO.	SIZE	BOX QTY.	VOL. QTY.
		R344500	TC-1020	1/8"-1 1/8 O.D.	1	3
		R344510	S76637	Roller Wheel	1	3



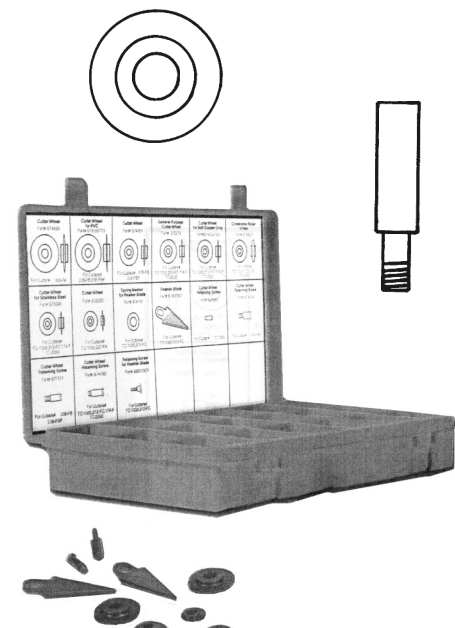

TUBE CUTTERS		CAT. NO.	MFG. NO.	SIZE/DESCRIPTION	BOX QTY.	VOL. QTY.
TUBE CUTTERS-PLASTIC TUBE						
 <p>R344600</p>	R344600	307-FP	1/16"-1/2" O.D.		(1)12	24
	R344650	S81156-01	Blade for 307-FP		1	6
	R344700	327-FP	1/8"-13/16" O.D.		1	6
	R344720	S77615	Blade for 327-FP		1	6
	R345000	206-FBP	1/4"-2 5/8" O.D.		1	3
	R345100	S10000770	Wheel for R345000		1	3
KWIKCUT						
 <p>R345000</p>  <p>R345310 - R345345</p>  <p>R345360</p>	R345310	T-100	Cuts P.E., P.B. & PVC (Class & Schedule 40) thru 1" I.D.		1	6 12
	R345315	BT-100	Blade for T-100		1	-
	R345320	T-135	Cuts P.E. & Hose thru 1 1/2" I.D., Class PVC & P.B. thru 1 1/4" I.D.		1	6 12
	R345325	BT-135	Blade for T-135		1	-
	R345340	SS-200	Cuts rubber hose thru 2" I.D. & P.E. thru 1 1/2" I.D.		1	6 12
	R345345	SSB-200	Blade for SS-200		1	-
LIGHT DUTY CUTTER						
	R345360	HC-32	Light Duty cuts hose 1/2" - 1 5/8" plastic handles with spring		1	6





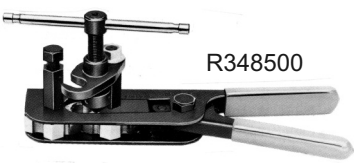

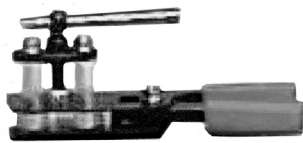

IMPERIAL TUBING CUTTER PARTS		CAT. NO.	MFG. NO.	SIZE/DESCRIPTION	BOX QTY.	VOL. QTY.
WHEELS						
	R345500	S32633	TC-1050, 227-FA		5	20
	R345600	S75015	174-F, TC-1000, TC-2050, 312-FC		5	20
	R345700	S75046	For Stainless Steel and hard temper tubing 174-F, TC-1000, 312-FC, TC-2050		5	20
	R345800	S74761	206-FB		5	20
	R345900	S74833	406-FA		1	10
	SCREWS (PINS)					
	R346200	S26883	TC-1050, 227-FA		1	10
	R346300	S74762	174-F, TC-1000, TC-2050, 312-FC		5	20
	R346400	S77511	206-FB		1	10
	R346450	S77507	Nut for S77511		1	10
	R346500	S74834	406-FA		1	10
PARTS KIT						
	R346600	144-F	Parts Kit		1	2

RICHARD SPECIALTY CO., INC.

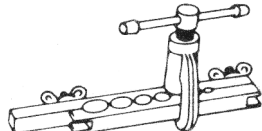
FLARING TOOLS

	CAT. NO.	MFG. NO.	FOR CUTTER NUMBER	BOX QTY.	VOL. QTY.
	R348500	2.6033	3/16" - 5/8" O.D.	1	2
	R348600	2.6034	Form-A-Gage 3/16" - 1/2" O.D.	1	2
	R348650	FT-100	3/16" - 5/8" O.D.	1	2
	R349000	945-TH Rolo-Flare	1/8" thru 3/4" O.D.	1	3

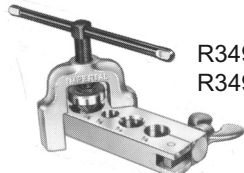
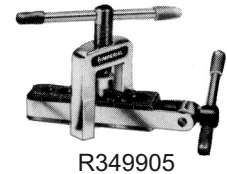
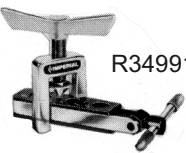
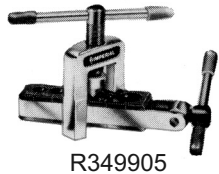

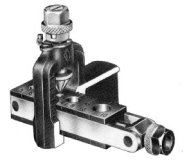
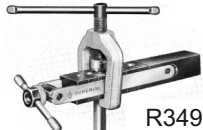
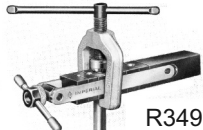
	CAT. NO.	MFG. NO.	SIZE	BOX QTY.	VOL. QTY.
FLARING TOOLS - 45°					
	R349150	Imported	3/16" - 5/8" O.D.	1	3
	R349200	195-FC	3/16" - 5/8" O.D.	1	3
	R349300	300-FB	3/16" - 5/8" O.D.	1	3
	R349400	500-FC	3/16" - 5/8" O.D.	1	3
	R349500	525-F	3/16" - 5/8" O.D.	1	2
	R349800 R349900	103-FS	3/4" - 7/8" & 1" O.D.	1	2
	R349900	203-FA	5/8", 3/4", 7/8" & 1 1/8" O.D.	1	2
FLARING TOOLS - 37°					
	R349905	437-FB	3/16" - 5/8" O.D.	1	2
	R349910	507-FB	3/16" - 5/8" O.D.	1	2
	R349915 and R349920	537-F	3/4", 7/8", 1 & 1 1/4" O.D.	1	2
	R349920	637-F	1 1/4", 1 1/2", & 2" O.D.	1	2
	R349925	400-F	3/16" - 5/8" O.D.	1	2
	R349930	447-F	1/8" - 1/2" O.D.	1	2

FLARING TOOLS		CAT. NO.	MFG. NO.	SIZE	BOX QTY.	VOL. QTY.
----------------------	--	----------	----------	------	----------	-----------

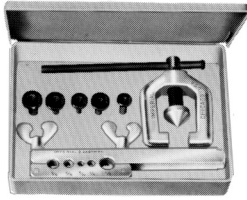

R350000

DOUBLE FLARING TOOLS - 45°

R350000	93-FB	3/16" - 1/2" O.D.	1	2
---------	-------	-------------------	---	---

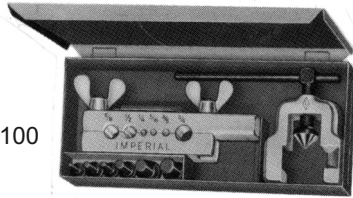

R350100

R350100	195-FB	1/4" - 3/4" O.D.	1	2
---------	--------	------------------	---	---

CAT. NO.	MFG. NO.	SIZE	TUBE CUTTER	FLARING TOOL	BOX QTY.	VOL. QTY.
----------	----------	------	-------------	--------------	----------	-----------



R350300

FLARING TOOL KITS - 45°

R350300	120-F	1/8" - 3/4" O.D.	TC-1000	375-FS	1	2
---------	-------	------------------	---------	--------	---	---

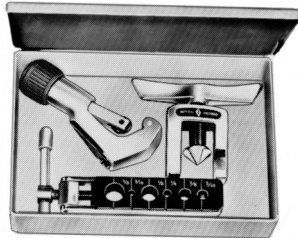
 R350500
R350600

R350500	123-FA	3/16" - 5/8" O.D.	TC-1000	300-FB	1	2
R350600	124-FA	3/16" - 5/8" O.D.	TC-1000	500-FC	1	2

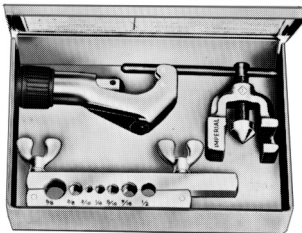

R350700

R350700	1226-FA	3/16" - 5/8" O.D.	TC-1000	195-FC	1	2
---------	---------	-------------------	---------	--------	---	---



R350800

R350800	375-FS	1/8" - 3/4" O.D.	In plastic kit		1	2
---------	--------	------------------	----------------	--	---	---

FLARING TOOLS

CAT. NO.

SIZE

BOX QTY. VOL. QTY.

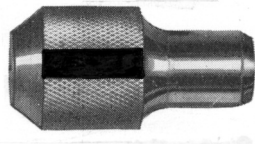

HAMMER FLARING TOOLS

R351300	3/4" I.D.	1	3
R351400	1" I.D.	1	3

SIZING TOOLS

CAT. NO.

SIZE

BOX QTY. VOL. QTY.

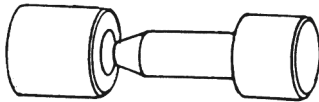

**Always deburr and lubricate before using all sizing tools.*

R351820	1/2" Type M tubing	1	3
R351825	3/4" Type M tubing	1	3
R351830	1" Type M tubing	1	3
R351835	1 1/4" Type M tubing	1	3
R351840	1 1/2" Type M tubing	1	3

SWAGING TOOLS

CAT. NO.

MFG. NO.

O.D. SIZE

NOM. SIZE

BOX QTY. VOL. QTY.



R351900 - R352600



R352700

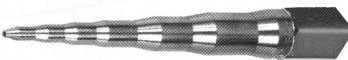

R352750



R352800



R352900

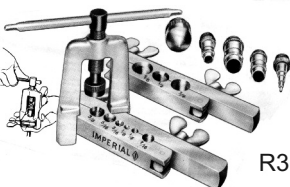

R353000

R351900	93-S-03	3/16"	-	1	2
R352000	93-S-04	1/4"	1/8"	1	2
R352100	93-S-05	5/16"	-	1	2
R352200	93-S-06	3/8"	1/4"	1	2
R352300	93-S-08	1/2"	3/8"	1	2
R352400	93-S-10	5/8"	1/2"	1	2
R352500	93-S-12	3/4"	5/8"	1	2
R352600	93-S-14	7/8"	3/4"	1	2
R352700	94-S	1/2", 5/8", 7/8"	3/8", 1/2", 3/4"	1	2
R352750	95-S	3/16", 1/4", 5/16", 3/8", 1/2", 5/8"		1	2
R352800	193-S	1/4, 3/8", 1/2", 5/8"	1/8", 1/4, 3/8", 1/2"	1	2
R352900	195-SA	1/4, 3/8", 1/2", 5/8"	1/8", 1/4, 3/8", 1/2"	1	2
R353000	275-FS	1/8" thru 3/4"	1/8" thru 5/8"	1	2

Includes 5 swage adapters for 3/16" to 3/4" O.D. In plastic kit.

FLARING TOOLS	CAT. NO.	MFG. NO.	DESCRIPTION	BOX QTY.	VOL. QTY.
----------------------	----------	----------	-------------	----------	-----------

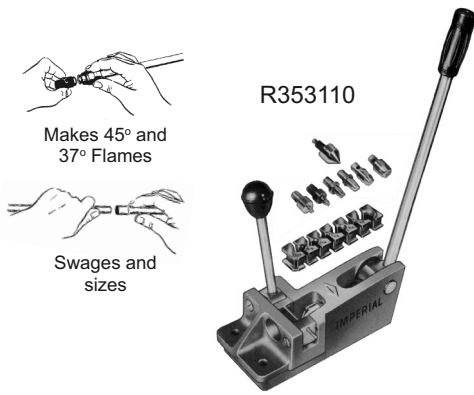

FLARING & SWAGING TOOL - 45° & 37° - Production

R353110	555-FS	3/16", 1/4", 5/16", 3/8", 1/2" & 5/8"		1	2
---------	--------	---------------------------------------	--	---	---



R353115

R353115	2000-FS	Flaring 1/8" thru 3/4" Double flaring 3/16" thru 3/4" Swaging 3/16" thru 3/4"		1	2
---------	---------	---	--	---	---

TUBING EXPANDER	CAT. NO.	MFG. NO.	EXPANDS TUBING SIZE	LENGTH	BOX QTY.	VOL. QTY.
------------------------	----------	----------	---------------------	--------	----------	-----------

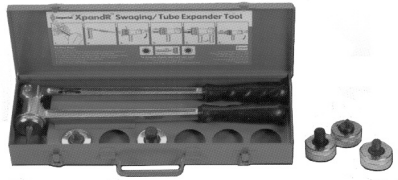

TUBING EXPANDER KIT

R353150	175-EX	3/8", 1/2", 5/8", 3/4", 7/8"			1	2
---------	--------	------------------------------	--	--	---	---



SMALL TUBING EXPANDER

R353300	137	3/8", 1/2", 5/8", 3/4"	8"		1	6
---------	-----	------------------------	----	--	---	---

TUBING BENDERS	CAT. NO.	MFG. NO.	QTY	O. D. SIZE	BOX QTY.	VOL. QTY.
-----------------------	----------	----------	-----	------------	----------	-----------



SPRING TYPE

R354000	102-F-04			1/4"	1	4*
R354100	102-F-05			5/16"	1	4*
R354200	102-F-06			3/8"	1	4*
R354300	102-F-07			7/16"	1	4*
R354400	102-F-08			1/2"	1	4*
R354500	102-F-10			5/8"	1	4*
R354600	102-F-12			3/4"	1	4*
R354700	102-F-14			7/8"	1	4*

*May Be Assorted For Volume Quantity.

SETS

R354800	201-F	8	1/4", 5/16", 3/8", 7/16", 1/2", 5/8", 3/4", 7/8"		1	2
R354900	163-F	4	1/4", 3/8", 1/2", 5/8"		1	2
R355000	112-F	3	1/4", 5/16", 3/8"		1	2

TUBE BENDERS

CAT. NO.	MFG. NO.	O. D. SIZE	BOX QTY.	VOL. QTY.
----------	----------	------------	----------	-----------

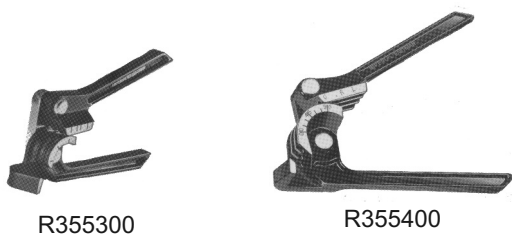

R355300

R355400

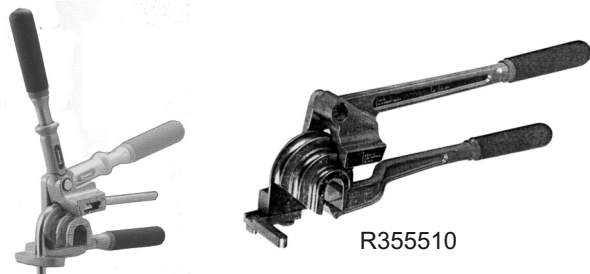

R355500

R355510



R355700 - R356700

R356705 - R356725



R356740 - R356750

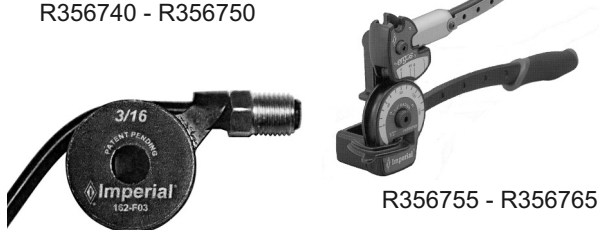

R356755 - R356765

R356780 - R356785



R356800
R356900
R357000

LEVER TYPE - TRIPLE HEADER

R355300	367-FH	1/8", 3/16", 1/4" O.D.	1	3
R355400	368-FH	3/16", 1/4", 5/16", 3/8" O.D.	1	3
R355500	470-FH	3/16", 1/4", 5/16", 3/8" O.D. with Roto-lok™ indexing handle	1	2
R355510	370-FH	3/16", 1/4", 3/8", 1/2" O.D.	1	2
R355700	364-FH-02	1/8"	1	2
R355800	364-FH-03	3/16"	1	2
R355900	364-FHA-04	1/4"	1	2
R356000	364-FHA-05	5/16"	1	2
R356100	364-FHA-06	3/8"	1	2
R356300	364-FHA-08	1/2"	1	2
R356400	364-FHA-10	5/8"	1	2
R356500	364-FHA-12	3/4"	1	2
R356600	364-FHA-14	7/8"	1	2
R356700	364-FHA-16	1"	1	2

Metric Benders Available 6MM, 8MM, 10MM, 12MM
Pricing On Application

LEVER TYPE - SWIVEL HANDLE

R356705	364-FHB-04	1/4"	1	2
R356710	364-FHB-05	5/16"	1	2
R356715	364-FHB-06	3/8"	1	2
R356720	364-FHB-07	7/16"	1	2
R356725	364-FHB-08	1/2"	1	2

LEVER BENDER FOR STAINLESS STEEL & OTHER TUBING

R356740	564-FH-06	3/8"	1	2
R356745	564-FH-08	1/2"	1	2
R356750	564-FHT-06	3/8" (Tighter radius)	1	2

ERGO180° BENDER WITH ROTOLock INDEXING HANDLE

R356755	664-FHT-04	1/4"	1	2
R356760	664-FHT-06	3/8"	1	2
R356765	664-FH-08	1/2"	1	2

MICRO TUBE BENDER MAKES INLINE BENDS

For Soft Copper and Aluminum Tubing

R356780	162-F03	3/16"	1	2
R356785	162-F04	1/4"	1	2

LEVER TYPE - KITS (In Metal Box)

R356800	260-FHA	1/4", 5/16", 3/8", 1/2", 5/8", 3/4", 7/8"	1	2
R356900	350-FHA	1/4", 5/16", 3/8", 1/2", 5/8", 3/4"	1	2
R357000	360-FHA	3/8", 1/2", 5/8", 3/4"	1	2

TUBE BENDERS

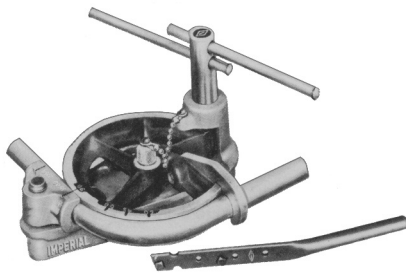

LEVER BENDERS GEAR TYPE

CAT. NO.	SIZE O.D.	NOM. SIZE	BENDING RADIUS TO CENTER OF TUBE	BOX QTY.	VOL. QTY.
R357300	3/8"	1/4"	1 3/4"	1	2
R357400	1/2"	3/8"	2 1/2"	1	2
R357500	5/8"	1/2"	3"	1	2
R357600	3/4"	5/8"	4"	1	2
R357700	7/8"	3/4"	4"	1	2
R357800	1"	—	4"	1	2
R357900	1 1/8"	1"	4"	1	2
R358000	Extension Handle			1	2

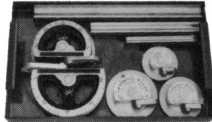

R358025



R358050

WORM GEAR TUBE BENDER

R358025	600-F	1/4" - 3/4" O.D.		1	2
---------	-------	------------------	--	---	---

RATCHET HAND BENDER

The original one hand bending tool for soft copper, aluminum and light wall hydraulic tubing. (Complete swing bender kit includes all items shown to bend 3/8", 1/2", 5/8", 3/4" and 7/8" O.D. Tubing Cutter, 1 1/8" with spare blade. 1-inside & outside reamer to 1" O.D.)

R358050	Ratchet Hand Bender			1	2
---------	---------------------	--	--	---	---

PINCH-OFF TOOL

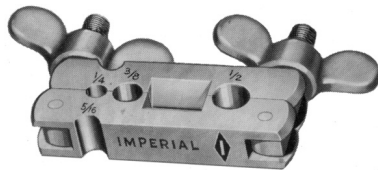

CAT. NO.	MFG. NO.	O. D. SIZE	BOX QTY.	VOL. QTY.
R358100	105-FF	1/4", 5/16", 3/8" & 1/2"	1	3

RATCHET WRENCHES KWIK TITE®

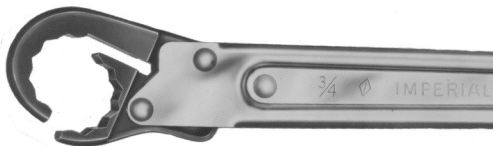



CAT. NO.	MFG. NO.	NUT HEX OF WRENCH	BOX QTY.	VOL. QTY.
RATCHET WRENCHES				
R358200	195-F-06	3/8"	1	3
R358300	195-F-07	7/16"	1	3
R358400	195-F-08	1/2"	1	3
R358500	195-F-09	9/16"	1	3
R358600	195-F-10	5/8"	1	3
R358700	195-F-11	11/16"	1	3
R358800	195-F-12	3/4"	1	3
R358900	195-F-13	13/16"	1	3
R359000	195-F-14	7/8"	1	3
R359100	195-F-15	15/16"	1	3
R359200	195-F-16	1"	1	3
R359202	195-F-18	1 1/8"	1	3
R359204	195-F-19	1 3/16"	1	3
R359206	195-F-20	1 1/4"	1	3
R359208	195-F-22	1 3/8"	1	3
R359210	195-F-24	1 1/2"	1	3
R359212	195-F-26	1 5/8"	1	3
R359214	195-F-28	1 3/4"	1	3
R359218	195-F-32	2"	1	3









KWIK TITE® KIT

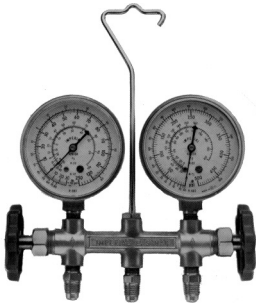

R359600	195-7 STDS	7 Pcs Kit 3/8" - 3/4"	1	2
---------	------------	-----------------------	---	---

RATCHET WRENCH		CAT. NO.	MFG. NO.	DESCRIPTION	BOX QTY.	VOL. QTY.
RATCHET WRENCH						
	R360100	124-C		3/16" & 1/4" square and 1/2" & 9/16" hex	1	6
	R360300	127-C		1/4", 3/8", 3/16", & 5/16" Square drive with reversible ratchets	1	4
	R360350	127-CO		1/4", 3/8", 3/16" & 5/16" 25° offset with reversible ratchets	1	4

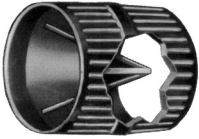
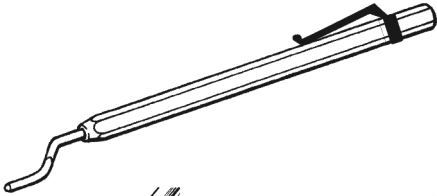

KWIK COUPLERS		CAT. NO.	MFG. NO.	DESCRIPTION	BOX QTY.	VOL. QTY.
	R360400	16-C		Straight Coupler (45° Flare) 1/4" female x 1/4" male	1	6
	R360410	17-C		90° Elbow Coupler (45° Flare) 1/4" female x 1/4" male	1	6
	R360420	18-C		(Set of 16-C and 17-C)	1	6

SERVICE MANIFOLDS		CAT. NO.	MFG. NO.	DESCRIPTION	BOX QTY.	VOL. QTY.
	R360430	496-C		2-valve manifold with gauges and charging lines	1	2
	R360435	495-C		2-valve manifold with gauges	1	2
	R360440	621-C		4-valve manifold with hoses	1	2
	R360445	620-C		4-valve manifold	1	2

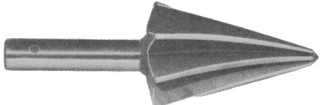
NOZZLES		CAT. NO.	MFG. NO.	DESCRIPTION	BOX QTY.	VOL. QTY.
STANDARD BLOWGUNS						
	R360600	18-202		Comfortable thumb lever valve control with handy hanger hole in lever and hanger hook. New, compact one piece nozzle.	1	6
SAFETY BLOWGUNS						
	R360700	18-232		New improved nozzle meets OSHA regulation 1001 for 30 PSI "dead head" pressure. Heavy duty die cast body. Complete with hang up hook and 1/4" NPT female inlet.	1	6
	R360800	BF-3/4		DRUM FAUCETS SELF CLOSINGS 3/4" iron pipe thread	1	12

REAMING & DEBURRING TOOLS		CAT. NO.	MFG. NO.	DESCRIPTION	BOX QTY.	VOL. QTY.
FOR COPPER, ALUMINUM AND BRASS						
	R361200	208-F		3/16" to 1 1/2"	1	4
FOR STAINLESS STEEL						
	R361300	208-FSS		3/16" to 1 1/2"	1	2
DEBURRER HAND TOOL						
	R361500			Handi Reamer Removes burred edges from inside plastic, steel, aluminum, brass or copper tubing and pipe. With swivel handle for fast deburring and pocket clip.	1	12 48
	R361800			Deburrer with 3 blades	1	10
	R361900			Package of 5 blades for R361800	1pk.	10pk.
IRON PIPE						
	R362300	1		1/4" to 1 1/4"	1	3
	R362400	2		1/4" to 2"	1	3

RICHARD SPECIALTY CO., INC.

SOCKET SETS		CAT. NO.	MFG. NO.	CONTENTS	BOX QTY.	VOL. QTY.	
R362410 R362420		R362410		1/4" & 3/8" Dual Ratchet	1	6	
		R362420		3/8" & 1/2" Dual Ratchet	1	6	
R362435		R362430	39100	16Pc Uni-Fit® Channellock Set	1	2	
		R362435	38054	24Pc Uni-Fit® Channellock Socket Set	1	2	
R362460		CHANNELLOCK MECHANICS SETS					
		R362450	39070	94Pc Mechanics Tool Set	1	2	
		R362455	39067	132Pc Mechanics Tool Set	1	2	
R362460		R362460	39053	171Pc Mechanics Tool Set	1	2	



WRIGHT TOOL

		CAT. NO.	MFG. NO.	CONTENTS	BOX QTY.	VOL. QTY.	
		1/4" DRIVE SOCKET SETS					
		R362500	212	12 pc. plus box 9 - Sockets Std. 6 pt. 3/16" to 1/2" 1 - Spinner Handle 1 - 2" Extension 1 - Ratchet 1 - Metal Box	1	2	
		R362600	223	23 pc. plus box 10 - Sockets Std. 6 pt. 5/32" to 1/2" 8 - Sockets Deep 6 pt. 3/16" to 1/2" 1 - Spinner Handle 1 - 2" Extension 1 - 6" Extension 1 - Ratchet 1 - Universal Joint 1 - Metal Box	1	2	

SOCKET SETS	CAT. NO.	MFG. NO.	SIZE	LENGTH	IN SET #212	IN SET #223	BOX QTY.	VOL. QTY.
-------------	----------	----------	------	--------	-------------	-------------	----------	-----------

1/4" DRIVE SOCKETS AND ATTACHMENTS

Standard 6 Point



R362650	2005	5/32"	7/8"		X		(1)5	5
R362700	2006	3/16"	7/8"	X	X		(1)5	5
R362800	2007	7/32"	7/8"	X	X		(1)5	5
R362900	2008	1/4"	7/8"	X	X		(1)5	5
R363000	2009	9/32"	7/8"	X	X		(1)5	5
R363100	2010	5/16"	7/8"	X	X		(1)5	5
R363200	2011	11/32"	7/8"	X	X		(1)5	5
R363300	2012	3/8"	7/8"	X	X		(1)5	5
R363400	2014	7/16"	7/8"	X	X		(1)5	5
R363500	2016	1/2"	7/8"	X	X		(1)5	5

Deep 6 Point

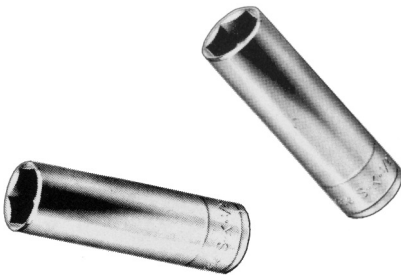

R363550	2506	3/16"	2"	-	X		(1)5	5
R363600	2508	1/4"	2"	-	X		(1)5	5
R363700	2509	9/32"	2"	-	X		(1)5	5
R363800	2510	5/16"	2"	-	X		(1)5	5
R363900	2511	11/32"	2"	-	X		(1)5	5
R364000	2512	3/8"	2"	-	X		(1)5	5
R364100	2514	7/16"	2"	-	X		(1)5	5
R364200	2516	1/2"	2"	-	X		(1)5	5



R364300	2426	Ratchet	4 3/4"	X	X		(1)5	5
---------	------	---------	--------	---	---	--	------	---

R364400	2401	Ratchet Renewal		-	-		1	5
---------	------	-----------------	--	---	---	--	---	---



R364600	2402	2" Extension		X	X		(1)5	5
---------	------	--------------	--	---	---	--	------	---

R364700	2406	6" Extension		-	X		(1)5	5
---------	------	--------------	--	---	---	--	------	---



R364800	2475	Universal 1/4" F - 14" M	1 5/16"	-	X		(1)5	5
---------	------	-----------------------------	---------	---	---	--	------	---

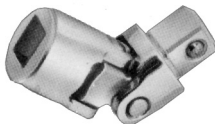

R364900	3452	Adapter 3/8" F - 1/4" M	1 1/16"	-	-		(1)5	5
---------	------	----------------------------	---------	---	---	--	------	---



R365000	2453	Adapter 1/4" F - 3/8" M	1"	-	-		(1)5	5
---------	------	----------------------------	----	---	---	--	------	---

SOCKET SETS

CAT. NO.	MFG. NO.	DESCRIPTION	BOX QTY.	VOL. QTY.
----------	----------	-------------	----------	-----------



3/8" DRIVE SOCKET SETS

R365500	304	10pc. 10-Sockets - deep 6 pt. Deep Socket 1-Rail 3/8" thru 7/8"	1	2
---------	-----	--	---	---

CAT. NO.	MFG. NO.	CONTENTS	BOX QTY.	VOL. QTY.
----------	----------	----------	----------	-----------



3/8" DRIVE SOCKET SETS

R366100	327	(11 pc. plus box) 7 - Sockets - 6pt. 3/8" thru 3/4" 1 - 6" Extension 1 - Ratchet 1 - Metal Box	1	2
---------	-----	---	---	---

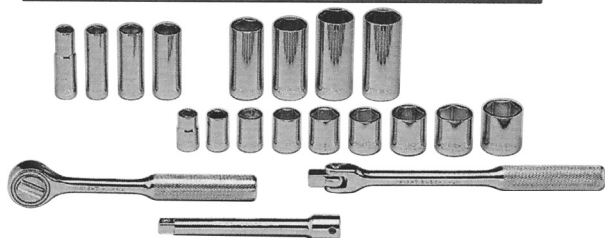
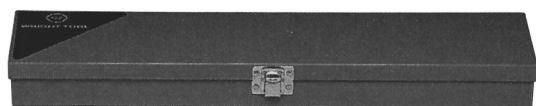

R366200	337	(21 pc. plus box) 7 - Sockets - 6pt. 3/8" thru 7/8" 7 - Sockets - 6pt. deep 3/8" thru 7/8" 1 - 6" Extension 1 - Flex Handle 1 - Ratchet 1 - Metal Box	1	2
---------	-----	---	---	---

CAT. NO.	MFG. NO.	SIZE	LENGTH	IN SET #327	IN SET #337	BOX QTY.	VOL. QTY.
----------	----------	------	--------	-------------	-------------	----------	-----------

3/8" DRIVE SOCKETS

Standard 6 Point



R366400	3012	3/8"	7/8"	X	X	(1)5	5
R366500	3014	7/16"	7/8"	X	X	(1)5	5
R366600	3016	1/2"	7/8"	X	X	(1)5	5
R366700	3018	9/16"	7/8"	X	X	(1)5	5
R366800	3020	5/8"	7/8"	X	X	(1)5	5
R366900	3022	11/16"	1"	X	X	(1)5	5
R367000	3024	3/4"	1"	X	X	(1)5	5
R367100	3026	13/16"	1 1/8"	X	X	(1)5	5
R367200	3028	7/8"	1 1/8"	X	X	(1)5	5

SOCKET SETS	CAT. NO.	MFG. NO.	SIZE	LENGTH	IN SET #304	IN SET #327	IN SET #337	BOX QTY.	VOL. QTY.
--------------------	----------	----------	------	--------	-------------	-------------	-------------	----------	-----------

3/8" DRIVE SOCKETS

Deep 6 Point



R367300	3512	3/8"	1 3/4"	X	-	X	(1)5	5
R367400	3514	7/16"	1 3/4"	X	-	X	(1)5	5
R367500	3516	1/2"	1 3/4"	X	-	X	(1)5	5
R367600	3518	9/16"	1 3/4"	X	-	X	(1)5	5
R367700	3520	5/8"	2 1/2"	X	-	X	(1)5	5
R367800	3522	11/16"	2 1/2"	X	-	X	(1)5	5
R367900	3524	3/4"	2 1/2"	X	-	X	(1)5	5
R368000	3526	13/16"	2 1/2"	X	-	X	(1)5	5
R368100	3528	7/8"	2 1/2"	X	-	X	(1)5	5

SOCKET SETS	CAT. NO.	MFG. NO.	SIZE	LENGTH	IN SET #304	IN SET #327	IN SET #337	BOX QTY.	VOL. QTY.
--------------------	----------	----------	------	--------	-------------	-------------	-------------	----------	-----------

3/8" DRIVE ATTACHMENTS



R368100	3426	Ratchet	7"	-	X	X	1	5
R368200	3491	Ratchet Renewal					1	2



R368300	3425	Ratchet	10"	-	-	-	1	3
---------	------	---------	-----	---	---	---	---	---

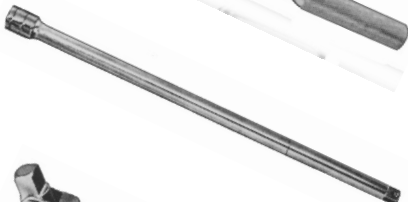

R368500	3402	Extensions	1 1/2"	-	-	-	(1)5	5
R368600	3403	Extensions	3"	-	X	X	(1)5	5
R368700	3405	Extensions	6"	-	X	X	(1)5	5
R368750	3412	Extensions	12"	-	-	-	(1)5	5



R368800	3435	Flex Handle	8 15/32"	-	-	-	(1)5	5
---------	------	-------------	----------	---	---	---	------	---

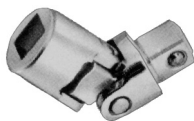

R368900	3475	Universal Joint	1 7/8"	-	-	-	(1)5	5
---------	------	-----------------	--------	---	---	---	------	---

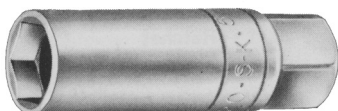

R369000	3590	Spark Plug Socket 6pt. 5/8"	2 1/2"	-	X	-	(1)5	5
---------	------	--------------------------------	--------	---	---	---	------	---

CROWFOOT WRENCHES

CAT. NO.	MFG. NO.	DESCRIPTION	BOX QTY.	VOL. QTY.
----------	----------	-------------	----------	-----------

3/8" DRIVE - OPEN END

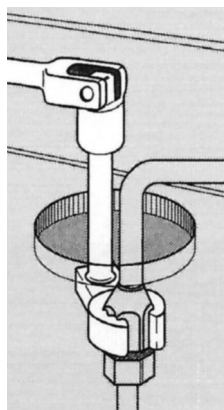

R369002	1012	3/8"	1	2
R369004	1014	7/16"	1	2
R369006	1016	1/2"	1	2
R369008	1018	9/16"	1	2
R369010	1020	5/8"	1	2
R369012	1022	11/16"	1	2
R369014	1024	3/4"	1	2
R369016	1026	13/16"	1	2
R369018	1028	7/8"	1	2
R369020	1032	1"	1	2



3/8" DRIVE - FLARE NUT 12PT

R369022	1060	5/8"	1	2
R369024	1062	1/16"	1	2
R369026	1064	3/4"	1	2
R369028	1066	13/16"	1	2
R369030	1068	7/8"	1	2
R369032	1070	15/16"	1	2
R369034	1072	1"	1	2
R369036	1074	1-1/16"	1	2

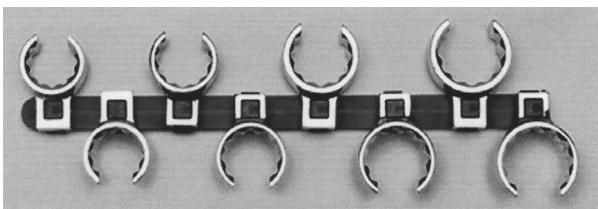

CROWFOOT WRENCH SET - 3/8" DRIVE

R369050	702	8 Piece set, 5/8" - 1 1/16" with clip rail	1	2
---------	-----	--	---	---

SOCKET SETS

CAT. NO.	MFG. NO.	DESCRIPTION	BOX QTY.	VOL. QTY.
----------	----------	-------------	----------	-----------

3/8" METRIC SETS



R369100	354	(14 pc. plus tray) 6mm thru 19mm 6 Pt Std Skt plus tray	1	2
---------	-----	---	---	---



R369300	355	(14 pc. plus Rail) 6mm thru 19mm 6 Pt Dp Skt plus rail	1	2
---------	-----	--	---	---

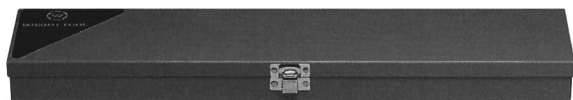

R369400	377	(27 pc. plus box) 6mm thru 19mm 6 Pt Std Skt 10mm thru 19mm 6 Pt Dp Skt 1 - 6" Extension 1 - Ratchet 1 - Flex Handle 1 - Metal Box	1	2
---------	-----	--	---	---

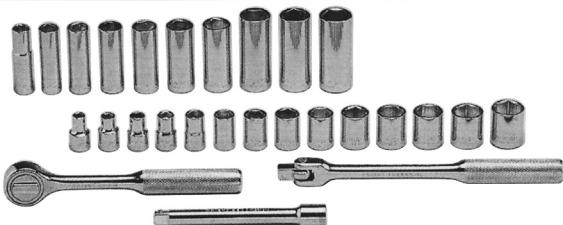

SOCKET SETS



1/2" DRIVE SOCKET SETS

CAT. NO.	MFG. NO.	SIZE	LENGTH	IN SET #304	IN SET #327	IN SET #337	BOX QTY.	VOL. QTY.
R370400	423	(18 pc. plus box)	3/8" thru 1 1/4" 6 Pt Std Skt				1	2
			1 - 5" Extension					
			1 - 16" Flex Handle					
			1 - 10 1/2" Ratchet					
			1 - Flex Handle					
			1 - Metal Box					

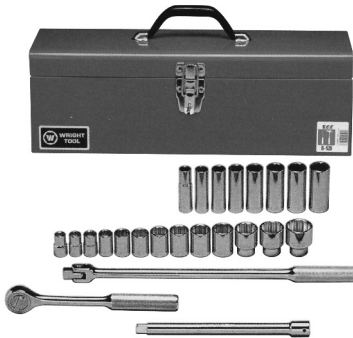

R370500	425	(24 pc. plus box)	7/16" thru 1 1/4" 12 Pt Std Skt				1	2
			1/2" thru 15/16" 12 Pt Dp Skt					
			1 - 10" Extension					
			1 - 16" Flex Handle					
			1 - Ratchet					
			1 - Metal Box					

CAT. NO.	MFG. NO.	SIZE	LENGTH	IN SET #423	IN SET #425	BOX QTY.	VOL. QTY.
----------	----------	------	--------	-------------	-------------	----------	-----------

1/2" DRIVE SOCKETS

Standard 6 Point

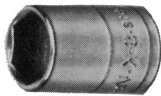

R370600	4014	7/16"	1 1/2"	X	-	(1)5	5
R370700	4016	1/2"	1 1/2"	X	-	(1)5	5
R370800	4018	9/16"	1 1/2"	X	-	(1)5	5

Standard 12 Point

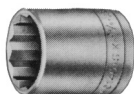

R370900	4120	5/8"	1 1/2"	-	X	(1)5	5
R371000	4122	11/16"	1 1/2"	-	X	(1)5	5
R371100	4124	3/4"	1 1/2"	-	X	(1)5	5
R371200	4126	13/16"	1 9/16"	-	X	(1)5	5

R371300	4128	7/8"	1 5/8"	-	X	(1)5	5
R371400	4130	15/16"	1 5/8"	-	X	(1)5	5
R371500	4132	1"	1 21/32"	-	X	(1)5	5
R371600	4134	1 1/16"	1 3/4"	-	X	(1)5	5

R371700	4136	1 1/8"	1 13/16"	-	X	(1)5	5
R371800	4138	1 3/16"	1 7/8"	-	X	(1)5	5
R371900	4140	1 1/4"	1 59/64"	-	X	(1)5	5

12 Point Deep Sockets

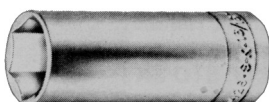

R372000	4616	1/2"	3 3/64"	-	X	(1)5	5
R372100	4618	9/16"	3 3/64"	-	X	(1)5	5
R372200	4620	5/8"	3 3/64"	-	X	(1)5	5
R372300	4622	11/16"	3 3/64"	-	X	(1)5	5
R372400	4624	3/4"	3 3/64"	-	X	(1)5	5
R372500	4626	13/16"	3 3/64"	-	X	(1)5	5
R372600	4628	7/8"	3 3/64"	-	X	(1)5	5

SOCKET SETS

CAT. NO.	MFG. NO.	SIZE	LENGTH	IN SET #423	IN SET #425	BOX QTY.	VOL. QTY.
----------	----------	------	--------	-------------	-------------	----------	-----------

1/2" DRIVE ATTACHMENTS

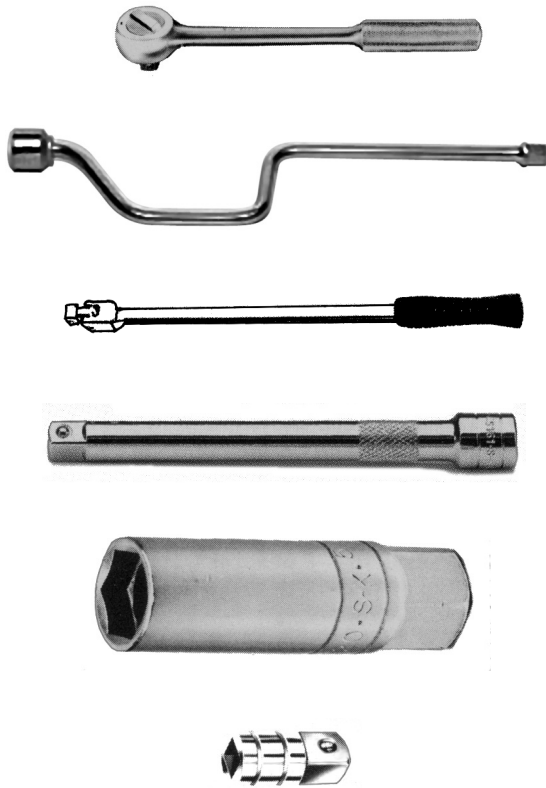

R372800	4426	Reversible Ratchet 1 1/4"	10 1/4"	X	X	(1)5	5
R372900	4491	Ratchet Renewal 1/2"		-	-	1	5
R373000	4425	Ratchet	15"	-	-	(1)2	2
R373100	4445	Speeder Handle 1/2"	16 3/4"	-	-	(1)2	2
R373200	4438	Flex Head Handle 1 1/8"	18"	X	X	(1)2	2
R373300	4402	Extension 5/8"	2"	-	-	(1)5	5
R373400	4405	Extension 5/8"	5"	X	X	(1)5	5
R373500	4410	Extension 5/8"	10"	-	-	(1)5	5
R373600	4590	Spark Plug Socket 5/8"		-	-	(1)5	5

ADAPTERS

R373900	4453	1/2" F - 3/8" M	1 1/2"	-	-	(1)5	5
R374000	3454	3/8" F - 1/2" M	1 3/8"	-	-	(1)5	5

CROWFOOT WRENCHES

CAT. NO.	MFG. NO.	DESCRIPTION	BOX QTY.	VOL. QTY.
----------	----------	-------------	----------	-----------

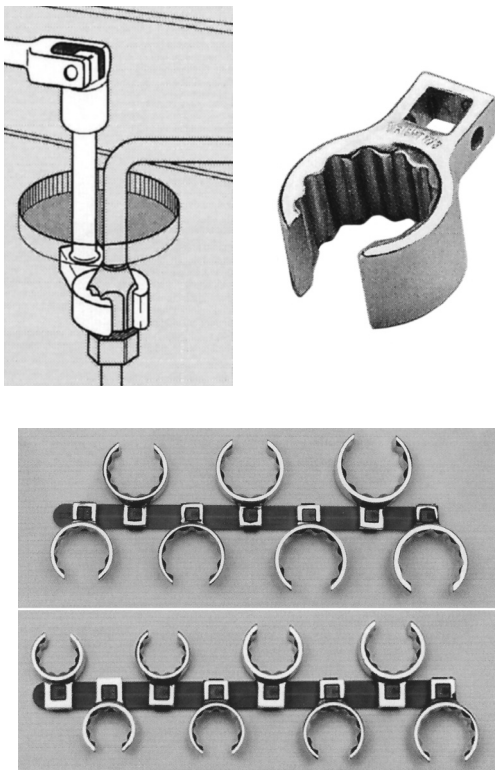

1/2" DRIVE - FLARE NUT 12PT

R374002	1080	1-1/8"	1	2
R374004	1081	1-3/16"	1	2
R374006	1082	1-1/4"	1	2
R374008	1083	1-5/16"	1	2
R374010	1084	1-3/8"	1	2
R374012	1085	1-7/16"	1	2
R374014	1086	1-1/2"	1	2
R374016	1087	1-9/16"	1	2
R374018	1088	1-5/8"	1	2
R374020	1089	1-11/16"	1	2
R374022	1090	1-3/4"	1	2
R374024	1091	1-13/16"	1	2
R374026	1092	1-7/8"	1	2
R374028	1093	1-15/16"	1	2
R374030	1094	2"	1	2

CROWFOOT WRENCH SET - 1/2" DRIVE

R374050	703	15 Piece set, 1 1/8" - 2" with clip rail	1	2
---------	-----	---	---	---

SOCKET SETS		CAT. NO.	MFG. NO.	DESCRIPTION	BOX QTY.	VOL. QTY.
--------------------	--	----------	----------	-------------	----------	-----------



3/4" DRIVE SOCKET SET

R374100	614	(14 pc. plus box) 7/8" thru 1 5/8" 12 Pt Std Skt 1 - Ratchet 1 - 8" Extension 1 - Metal Box	1	2
---------	-----	---	---	---

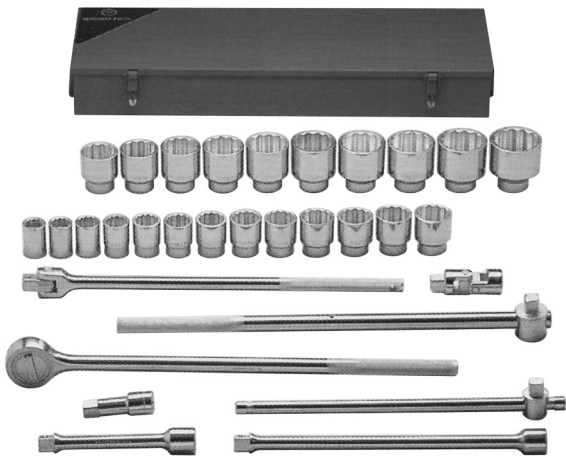

R374200	631	(31 pc. plus box) 7/8" thru 2 3/8" 12 Pt Std Skt 1 - Ratchet 1 - Slide T. Handle 1 - 3 1/2" Extension 1 - 8" Extension 1 - 16" Extension 1 - Flex Handle 1 - Bull Bar 1 - Universal 1 - Metal Box	1	2
---------	-----	---	---	---

COMBINATION WRENCHES		CAT. NO.	MFG. NO.	SIZE	LENGTH	BOX ENDS	BOX QTY.	VOL. QTY.
-----------------------------	--	----------	----------	------	--------	----------	----------	-----------

COMBINATION WRENCHES - ALLOY



R374500	1108	1/4"	4 59/64"	12 pt	(1)5	5
R374600	1110	5/16"	5 1/2"	12 pt	(1)5	5
R374700	1112	3/8"	6"	12 pt	(1)5	5
R374800	1114	7/16"	6 1/2"	12 pt	(1)5	5
R374900	1116	1/2"	7 5/32"	12 pt	(1)5	5
R375000	1118	9/16"	7 15/16"	12 pt	(1)5	5
R375100	1120	5/8"	8 35/64"	12 pt	(1)5	5
R375200	1122	11/16"	9 1/8"	12 pt	(1)5	5
R375300	1124	3/4"	10 3/64"	12 pt	(1)5	5
R375400	1126	13/16"	10 53/64"	12 pt	(1)5	5
R375500	1128	7/8"	11 3/4"	12 pt	(1)5	5
R375600	1130	15/16"	12 9/16"	12 pt	(1)5	5
R375700	1132	1"	13 5/16"	12 pt	1	2
R375800	1134	1 1/16"	14 1/4"	12 pt	1	2
R375900	1136	1 1/8"	15 1/8"	12 pt	1	2
R375950	1138	1 3/16"	16"	12 pt	1	2
R376000	1140	1 1/4"	16 13/16"	12 pt	1	2
R376100	1142	1 5/16"	19"	12 pt	1	2
R376200	1144	1 3/8"	20"	12 pt	1	2
R376300	1146	1 7/16"	21"	12 pt	1	2
R376400	1148	1 1/2"	22"	12 pt	1	2



COMBINATION WRENCHES

CAT. NO.	MFG. NO.	SIZE	LENGTH	BOX ENDS	BOX QTY.	VOL. QTY.
----------	----------	------	--------	----------	----------	-----------

COMBINATION WRENCHES - ALLOY (CONTINUED)



R376405	1152	1 5/8"	23"	12 pt	1	2
R376410	1154	1 11/16"	23"	12 pt	1	2
R376415	1156	1 3/4"	25 1/2"	12 pt	1	2
R376420	1158	1 13/16"	25 1/2"	12 pt	1	2
R376425	1160	1 7/8"	28"	12 pt	1	2
R376430	1164	2"	28"	12 pt	1	2
R376435	1166	2 1/16"	28 1/4"	12 pt	1	2
R376440	1168	2 1/8"	28 1/2"	12 pt	1	2
R376445	1170	2 3/16"	28 3/4"	12 pt	1	2
R376450	1172	2 1/4"	29"	12 pt	1	2
R376455	1176	2 3/8"	29 1/4"	12 pt	1	2
R376460	1180	2 1/2"	29 1/2"	12 pt	1	2
R376465	1182	2 9/16"	29 3/4"	12 pt	1	2
R376470	1184	2 5/8"	29 3/4"	12 pt	1	2
R376475	1188	2 3/4"	29 3/4"	12 pt	1	2

CAT. NO.	MFG. NO.	DESCRIPTION	BOX QTY.	VOL. QTY.
----------	----------	-------------	----------	-----------

COMBINATION WRENCH SETS



R377100

R377100	705	(7pc. plus pouch)	1/4" thru 3/4"	1	3
---------	-----	-------------------	----------------	---	---

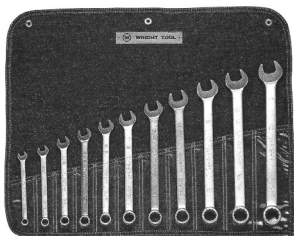

R377300



R377450

R377300	711	(11pc. plus roll)	3/8" thru 1"	1	2
R377400	714	(14pc. plus roll)	3/8" thru 1 1/4"	1	2
R377450	38040	Channellock 6pc. SAE Ratcheting Wrench Set	5/16" thru 5/8"	1	2

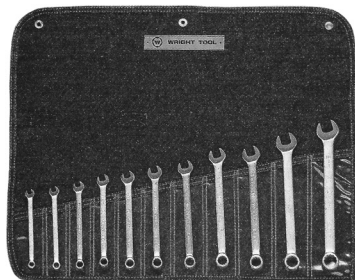

R377500



R377520

METRIC

R377500	750	(11pc. plus pouch)	7MM thru 19MM	1	2
R377510	758	(16pc. plus pouch)	6MM thru 22MM	1	2
R377520	38041	Channellock 6pc. Metric Ratcheting Wrench Set	8, 10, 12, 13, 14, 15MM	1	2

OPEN END WRENCHES



OPEN END WRENCHES - SUPERKROME®

CAT. NO.	MFG. NO.	SIZE	LENGTH	BOX QTY.	VOL. QTY.
R377600	1310*	1/4" x 5/16"	4 1/2"	1(5)	5
R377700	1314*	3/8" x 7/16"	5 3/4"	1(5)	5
R377800	1316*	7/16" x 1/2"	6 3/8"	1(5)	5
R377900	1318	1/2" x 9/16"	7"	1(5)	5
R378000	1320*	9/16" x 5/8"	7 5/8"	1(5)	5
R378050	1322*	5/8" x 11/16"	8 1/4"	1(5)	5
R378100	1325*	11/16" x 3/4"	9 1/8"	1(5)	5
R378200	1329*	13/16" x 7/8"	10 3/4"	1(5)	5
R378300	1332*	15/16" x 1"	12 5/16"	1(5)	5

(*In set below)



OPEN END WRENCH SET

R378400	738	(8pc plus roll)	1/4" thru 1 1/8"	1	2
---------	-----	-----------------	------------------	---	---

BOX END WRENCHES

CAT. NO.	MFG. NO.	SIZE	LENGTH	BOX QTY.	VOL. QTY.
----------	----------	------	--------	----------	-----------

BOX END WRENCHES

Long Pattern - 12 point



R379300	51214	3/8" x 7/16"	7 19/32"	1(5)	5
R379400	51416	7/16" x 1/2"	8 3/16"	1(5)	5
R379500	51618	1/2" x 9/16"	8 3/4"	1(5)	5
R379600	51820	9/16" x 5/8"	9 3/8"	1(5)	5
R379700	52024	5/8" x 3/4"	11 15/32"	1(5)	5
R379800	52224	11/16" x 3/4"	11 15/32"	1(5)	5
R379900	52628	13/16" x 7/8"	12 9/16"	1(5)	5
R380000	53032	15/16" x 1"	13 9/16"	1(5)	5

COMBINATION WRENCHES

CAT. NO.	MFG. NO.	SIZE	IN SET #743	BOX QTY.	VOL. QTY.
----------	----------	------	-------------	----------	-----------

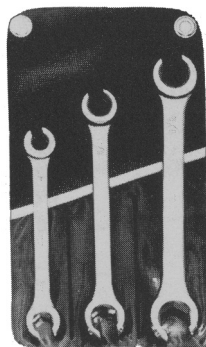

FLARE NUT WRENCHES

R380200	1614	3/8" x 7/16"	X	1(5)	5
R380300	1618	1/2" x 9/16"	X	1(5)	5
R380400	1622	5/8" x 11/16"	X	1(5)	5
R380700	1628	3/4" x 7/8"	-	1(5)	5

FLARE NUT WRENCH SET

R380900	743	(3 pc plus roll)		1	2
---------	-----	------------------	--	---	---

RICHARD SPECIALTY CO., INC.

RAPID WRENCH

CAT. NO.	MFG. NO.	DESCRIPTION	BOX QTY.	VOL. QTY.
----------	----------	-------------	----------	-----------



R382100



ADJUSTABLE RATCHETING SOCKET WRENCH

(Replaces 38 most popular socket sizes)

R382100		Rapid Wrench	1	6
---------	--	--------------	---	---

UNI-FIT RATCHETING WRENCH SET

R382300	38053	2pc. Uni-Fit Ratcheting Wrench SAE sizes: 5/16, 3/8, 7/16, 1/2, 9/16, 5/8, 11/16, 3/4" Metric sizes: 8, 10, 11, 13, 14, 16, 17, 19MM	1	6
---------	-------	--	---	---

FLANGES

CAT. NO.	DESCRIPTION	BOX QTY.	VOL. QTY.
----------	-------------	----------	-----------

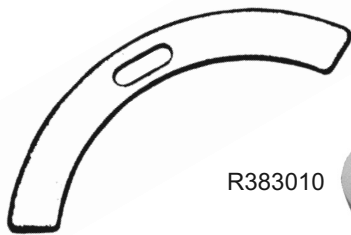

R383000

SPANNER FLANGE

R383000	Repairs broken closet flanges. One piece extender for closet flange.	1	12
---------	---	---	----

R383010

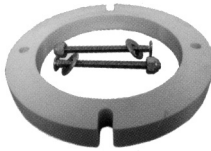

TOILET FLANGE EXTENDERS

R383010	1/2" closet flange extender	1	20
---------	-----------------------------	---	----

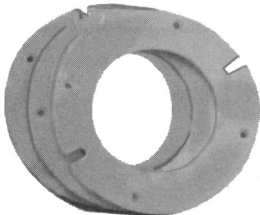

R383025

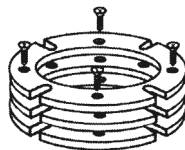

R383030

THREE PIECE EXTENDER FOR CLOSET FLANGE

R383025	3-1/4" pieces w/bolts for ABS	1	20
R383030	3-1/4" pieces w/bolts for PVC	1	20

Cross Section Views

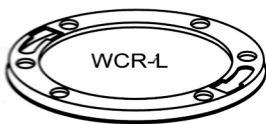

R383035

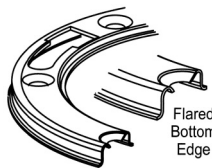

Flared Bottom Edge

WATER CLOSET RING EXTENSION

- WCR-L flared bottom edge suitable for reconstructing damaged existing installations
- Corrosion resistant
- Fits securely over damaged flange
- Available with tapered (flared) (WCR-L) or straight (WCR-NL) edge



R383037

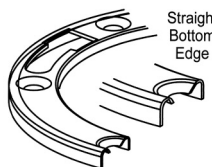

Straight Bottom Edge

R383035	WCR-L	Stainless steel with flared (tapered) bottom edge	1	20
---------	-------	---	---	----

R383037	WCR-NL	Stainless steel with flush (straight) bottom edge	1	20
---------	--------	---	---	----

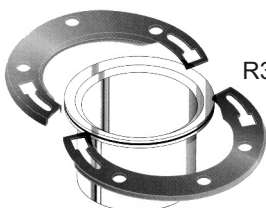

R383040

BAY FLANGE

R383040	Bay Flange	1	6
---------	------------	---	---

FLANGES

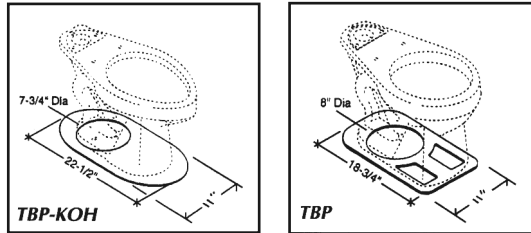

CAT. NO.	DESCRIPTION	BOX QTY.	VOL. QTY.
R383050	TBP-Square	1	12
R383055	TBP-KOH Round	1	12

CLOSET FLANGE SPACERS



KOLLAR KAP CLOSET FLANGE SPACERS

(The original styrofoam closet flange spacer.)

CAT. NO.	SIZE	DESCRIPTION	BOX QTY.	VOL. QTY.
R383300	3"	Eliminates needless chipping of concrete.	(18)120	*
R383400	4"	The spacer is made of polystyrene molded into a non-porous finish. Break away or melt with flame.	(12)120	*

*Check price sheet for volume quantity.

CRETE SLEEVE-PLASTIC HOLE FORMS

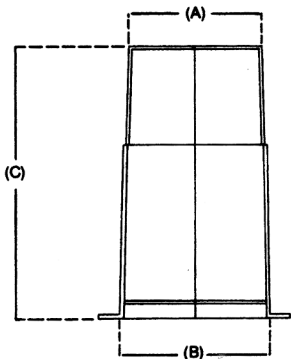

Dimensions shown at points A & B are actual hole diameters. Dimension C refers to height.

PLASTIC HOLE FORMS

- (1) For slabs deeper than 8 3/4", telescope two or more together.
- (2) For slabs shallower than 8 3/4" or for a smooth slab finish, cut off the tops of Crete-Sleeve™ Forms and push them through the bottom halves.

R383500	1 1/2"	(1)100	100
R383505	2"	(1)100	100
R383510	3"	(1)50	50
R383515	4"	(1)50	50
R383520	5"	(1)30	30
R383525	6"	(1)30	30
R383530	8"	(1)10	10
R383535	10"	(1)10	10
R383540	12"	(1)10	10

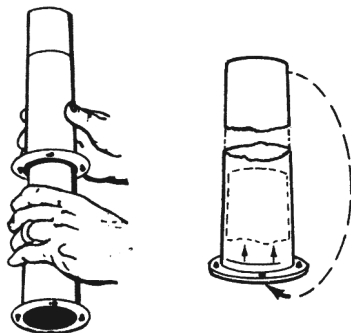

SIZE CHART Diameters from 1 1/2" to 12"

Top Hole Dia. (A)	1 1/2"	2"	3"	4"	5"	6"	8"	10"	12"
Bottom Hole Dia. (B)	1 3/4"	2 13/32"	3 13/32"	4 13/32"	5 13/32"	6 13/32"	8 7/16"	10 7/16"	12 7/16"
Overall Length (C)	8 3/4"	8 3/4"	8 3/4"	8 3/4"	8 3/4"	8 3/4"	8 3/4"	9 1/8"	9 1/8"

RICHARD SPECIALTY CO., INC.

TUB DRAIN BOX

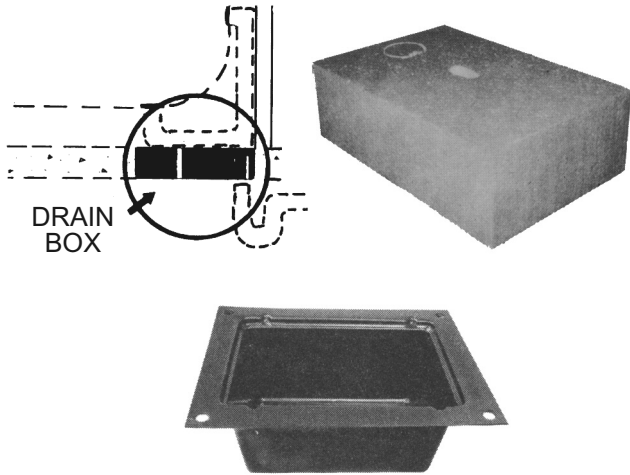

CAT. NO.	DESCRIPTION	BOX QTY.	VOL. QTY.
----------	-------------	----------	-----------

TUB DRAIN BOX COVERS

R383700	Made of polystyrene molded into a non-porous finish. Covers tub drain and is secured by driving wooden stake in hole. Eliminates building wooden boxes. (12" x 8" x 3 3/4")	1	72
---------	---	---	----

PLASTIC TUB BOX

	Length x Width x Depth	BOX QTY.	VOL. QTY.
R383720	13" x 13" x 7"	1	20
R383730	12" x 8 1/8" x 6 1/2"	1	20

CHEMICALS AND COMPOUNDS

CAT. NO.	MFG. NO.	CONTAINER SIZE	BOX QTY.	VOL. QTY.
----------	----------	----------------	----------	-----------



FORM-A-GASKET #1

Improves gasket sealing power, adds reliability to rigid or permanent assemblies.

R383800	80007	1A	1 1/2 oz. Tube	12	24
R383900	80008	1B	3 oz. Tube	12	24
R384000	80003	1C	11 oz. Tube	12	24

FORM-A-GASKET #2

Increases reliability of gasket seal on flexible assemblies.

R384400	80015	2A	1 1/2 oz. Tube	12	24
R384500	80016	2B	3 oz. Tube	12	24
R384600	80011	2C	11 oz. Tube	12	24



AVIATION FORM-A-GASKET #3

Improves reliability of seal on close fitting parts.

R385000	80017	3D	16 oz. Bottle	12	24
R385100	80019	3H	4 oz. Bottle	12	24

SILICONE FORM-A-GASKET BLUE

Solves sealing emergencies quickly. Replaces many types of gaskets.

R385300	80628	6C	11 oz. Cartridge	12	24
---------	-------	----	------------------	----	----



HIGH TEMPERATURE SILICONE FORM-A-GASKET RED

R385410	81160	26B	3 oz. Tube	12	24
R385420	81409	26C	11 oz. Cartridge	12	24



CHEMICALS AND COMPOUNDS

CAT NO.	MFG. NO.	CONTAINER SIZE	BOX QTY.	VOL. QTY.
---------	----------	----------------	----------	-----------



THREAD SEALANT WITH TEFLON

Improves sealing reliability of connections. Speeds assembly, cleanup.

R385500	80632	14H	4 oz. Bottle	12	24
R385600	80633	14D	16 oz. Bottle	12	24

PIPE JOINT COMPOUND

Improves reliability of connections. Versatile, easy.

R386100	80045	51D	16 oz. Bottle	12	24
---------	-------	-----	---------------	----	----

H.V.A.C. BLUE PIPE JOINT COMPOUND

Seals natural and L.P. gas-Temp. to 400°F.

R386110	82480		4 oz. Bottle	12	24
R386120	82481		16 oz. Bottle	12	24



BLUE MONSTER®

THREAD SEAL COMPOUND WITH PTFE

R386130	76001		1/4 Pint (4fl.oz. - 118ml)	24	48
R386135	76003		1/2 Pint (8fl.oz. - 237ml)	24	48
R386140	76005		1 Pint (16fl.oz. - 473ml)	24	48
R386145	76017		1 Quart (32fl.oz. - .95L)	24	48



PVC CADDY

R386200			PVC Caddy for quart/pint cans	1	12
---------	--	--	-------------------------------	---	----

SOLVO RUST-SUPER PENETRATING OIL

Speeds disassembly of parts. Keeps parts clean. Easy to use.

R386600	80032	68D	1 pt. Spout Top Can	12	24
---------	-------	-----	---------------------	----	----

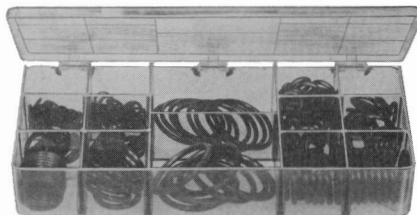

O-RING KIT

R387100			200 Assorted Rings in 12 sizes	1	2
---------	--	--	--------------------------------	---	---

R387150			O-Ring Pick	1	6
---------	--	--	-------------	---	---



CALFONEX PIPE BREAK

A superior penetrant that is NOT an oil - works through water to cut rust and corrosion. Loosens frozen parts, replaces cleaners and lubricants.

R387200				1cs	3cs
---------	--	--	--	-----	-----

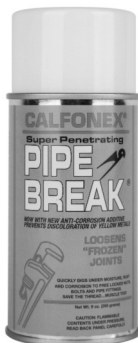

SUPER GLUE® ADHESIVE

Instantly bonds close fitting parts in seconds, with strengths up to 5000 psi. Works on rubber, glass, ceramics, aluminum, steel, alloys, plastics, vinyl and most non-porous surfaces.

R387300	49450		1 oz. Bottle	6	12
---------	-------	--	--------------	---	----

RICHARD SPECIALTY CO., INC.

CHEMICALS AND COMPOUNDS



CALCI-SOLVE

CAT. NO.	MFG. NO.	CONTAINER SIZE	BOX QTY.	VOL. QTY.
R387600		Quarts	(1cs) 12	(5cs) 60
R387700		Gallons	4	40

DRAIN SOLVE

CAT. NO.	MFG. NO.	CONTAINER SIZE	BOX QTY.	VOL. QTY.
R387710		Quarts	(1cs) 12	(5cs) 60
R387720		Gallons	4	40

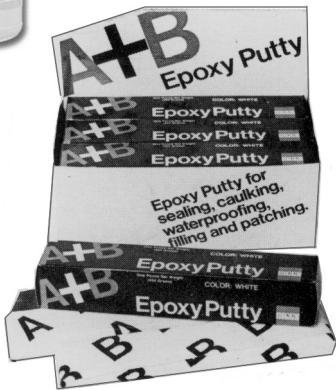

A & B EPOXY PUTTY

R388200	For plumbing repair to seal leaks in PVC and metal pipes, faucets and drains. Repair leaks and cracks on gas, diesel and oil tanks, water, sewage or disposal tanks. 1 lb. package.	(6)24	24
R388300	Repairs cracks, chips and leaks in sinks, bathtubs, showers and toilets. Adheres to damp surfaces. 1 lb. package. Color: White.	(6)24	24
R388400	A & B Fast Epoxy Putty cures above or below water. Sets up in 5 min. For plumbing leaks, patch concrete sidewalks, driveways and pools. 1/2 lb. package. Color: Neutral.	1	6



A & B EPOXY PASTE

R388900	A & B Fast Set Paste. Same repairing capabilities as Regular Epoxy Paste, but cures in just minutes. 2 tubes per package. 5 oz.	1	6
---------	---	---	---

CAULKING GUNS

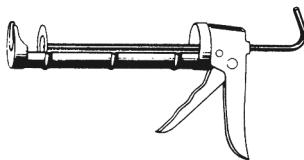



CAT. NO.	CONTAINER SIZE	DESCRIPTION	BOX QTY.	VOL. QTY.
----------	----------------	-------------	----------	-----------

CAULKING GUNS

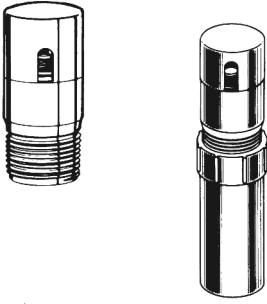
R389300	Takes 11 oz. Cartridge	8 1/2" Long Barrel 2 1/8" Diam. Steel Construction	1	12
---------	------------------------	--	---	----

AUTOMATIC TRAP VENT		CAT. NO.	DESCRIPTION	BOX QTY.	VOL. QTY.
		PRO VENTS			
		R390100	Pro Vent for venting or reventing.	1	50
		R390150	Pro Vent - Import	1	50
		R390200	Pro Vent with 5 1/4" Adapter	1	50

AIR ADMITTANCE VALVES		CAT. NO.	DESCRIPTION	BOX QTY.	VOL. QTY.
		CERTIFIED TO ASSE 1050 AND ASSE 1051			
		R390250	1 1/2" Male thread	1	25
		R390255	1 1/2" Frost Cap-Expanded polystyrene for R390250	1	72
		R390260	3" DWV spigot end	1	18
		R390265	3" Frost Cap	1	72

TOW STRAPS & RATCHET TIE DOWNS		CAT. NO.	MFG. NO.	DESCRIPTION	BOX QTY.	VOL. QTY.
		TOW STRAPS				
		R391400	66068	1 3/4" x 15' 10K Tow Strap with Safety Hook	1	2
	R391405	66069	2" x 20' 20K Tow Strap with Loop Ends	1	2	
		RATCHET TIE DOWNS				
		R391420	66041	1" x 8' 1.5K Tie Down with coated "S" Hooks (2 pieces)	1	2
	R391430	66077	1" x 10' 3K Tie Down with "S" Hook	1	2	

RICHARD SPECIALTY CO., INC.

TOW STRAPS & RATCHET TIE DOWNS

CAT. NO.	MFG. NO.	DESCRIPTION	BOX QTY.	VOL. QTY.
----------	----------	-------------	----------	-----------

RATCHET TIE DOWNS



R391435	66059	1" x 15' 1.5M Tie Down with "S" Hook (4 pieces)	1	2
R391450	11215JH	1 1/2" x 15' 5K Ratchet Assembly with Twin J-Hook	1	2
R391455	11220JH	1 1/2" x 20' 5K Ratchet Assembly with Twin J-Hook	1	2
R391460	220JH	2" x 20' 5K Ratchet Assembly with Twin J-Hook	1	2
R391465	227JH	2" x 27' 5K Ratchet Assembly with Twin J-Hook	1	2
R391470	230JH	2" x 30' 5K Ratchet Assembly with Twin J-Hook	1	2

RUBBER STRAPS & BUNGEE CORDS

CAT. NO.	LENGTH	BOX QTY.	VOL. QTY.
----------	--------	----------	-----------

HEAVY DUTY BUNGEE CORDS



R391500	10MM x 18"	(1)50	50
R391505	10MM x 24"	(1)50	50
R391510	10MM x 32"	(1)50	50
R391515	10MM x 40"	(1)50	50
R391520	10MM x 48"	(1)50	50

CAT. NO.	STRAP LENGTH	OVRALL LENGTH	STRETCH LENGTH	BOX QTY.	VOL. QTY.
----------	--------------	---------------	----------------	----------	-----------

RUBBER TIE - DOWN STRAPS With Attached "S" Hooks

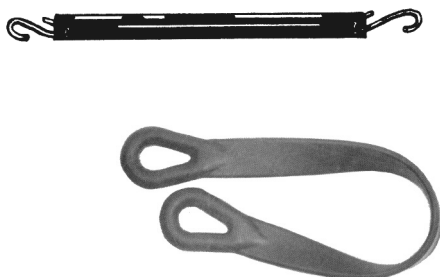

R392000	10"	13"	17"	(1)50	50
R392100	15"	19"	26"	(1)50	50
R392200	21"	25"	36"	(1)50	50
R392300	31"	35"	53"	(1)50	50
R392400	41"	45"	70"	(1)50	50
R392405	All purpose utility strap 22" long			1	36

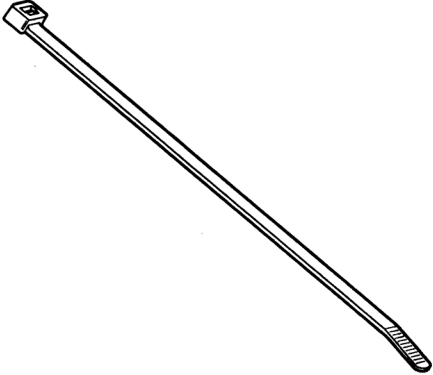

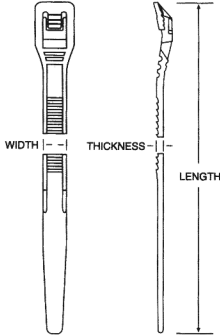
CABLE TIES		CAT. NO.	LENGTH	MAX BUNDLE DIAMETER	BOX QTY.	VOL. QTY.
NATURAL						
	R392410	4"	5/8"	100	500	
	R392412	5 1/2"	1 1/4"	100	500	
	R392414	7 1/2"	1 3/4"	100	500	
	R392416	11"	3"	100	500	
	R392418	14"	4"	100	500	
	R392420	14" (120#)	4"	100	500	
NATURAL - FOR DUCT						
	R392424	24" (175#)	6" Duct	50	250	
	R392426	36" (175#)	10" Duct	50	250	
	R392430	48" (175#)	14" Duct	50	250	
BLACK						
	R392440	4"	5/8"	100	500	
	R392442	5 1/2"	1 1/4"	100	500	
	R392444	7 1/2"	1 3/4"	100	500	
	R392446	11"	3"	100	500	
	R392448	14"	4"	100	500	
	R392450	14" (120#)	4"	100	500	

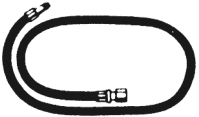
LOW PROFILE CABLE TIES		CAT. NO.	LENGTH	MAX BUNDLE DIAMETER	BOX QTY.	VOL. QTY.
	R392455	7 1/2" Natural	1 3/4"	100	500	
	R392460	7 1/2" Black	1 3/4"	100	500	
	R392466	14" Natural	3"	100	500	
	R392468	14" Black	3"	100	500	













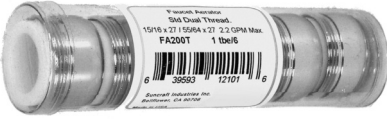



RINSE QUIK		CAT. NO.	MFG. NO.	DESCRIPTION	BOX QTY.	VOL. QTY.
RINSE QUIK - COMPLETE HOSE AND SPRAY HEAD						
	R392500	MR-422-4		Std. Head with 4 ft. hose. Universal Coupling	1	48*
	R392550			Hose & Spray-Import	1	48*
	R392560			Black Hose & Black Head	1	48*
	R392565			White Hose & White Head	1	48*
	R392570			Bone Hose & Bone Head	1	48*
	R392575			Natural Hose & Chrome Head	1	48*
	R392600	MR-422-4C		Same as Mr-422-4 except with 1/4" union nut on hose for Delta Faucets	1	48*
R392650	441-36		Universal Coupling-Brass	1	48*	
HOSES						
	R392700	MR-4		Std. 4 ft. hose with Universal Coupling	1	48*
	R392800	MR-4C		4 ft. with 1/4" union nut for Delta Faucets	1	48*
	R392820	MR-4WV		White 4 ft. hose with Universal Coupling	1	48*
	R392840	MR-4TV		Bone 4 ft. hose with Universal Coupling	1	48*
	R392860	MR-4BV		Black 4 ft. hose with Universal Coupling	1	48*

*May Be Assorted For Volume Quantity.









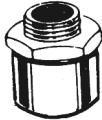
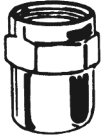

RICHARD SPECIALTY CO., INC.

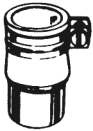
RINSE QUIK		CAT. NO.	MFG. NO.	DESCRIPTION	BOX QTY.	VOL. QTY.
SPRAY HEADS						
		R392900	MR-422	Black standard head. Attaches to any existing hose.	1	48*
		R392905		Head-Black-Import	1	48*
		R392910	MR-427-WH	White standard head. Attaches to any existing hose.	1	48*
		R392920	MR-427-BW	Bone standard head interchangeable with any sink spray.	1	48*
		R392930	MR-427-C	Chrome standard head. Attaches to any existing hose.	1	48*
R392900 to R392930	R393000	R393000	MR-421	Shampoo head interchangeable with any sink spray.	1	48*
*May Be Assorted For Volume Quantity.						
KITCHEN PULL OUT SPRAY HEAD & HOSE						
		R393010		White with Black Face	1	6
R393010		R393015		White	1	6
	R393015					
		R393020		Chrome finish	1	6
R393020						
		R393025		Hose Replacement	1	6
R393025		R393030		Hose Replacement with adaptor kit	1	6
	R393030					
HOSE GUIDES						
		R393100	MR-200	Hose guide - Black	1	48*
		R393110	MR-200-WHWC	Hose guide - White	1	48*
		R393120	MR-200-BWBC	Hose guide - Bone	1	48*
DESIGNER SPRAY HEADS						
		R393305	MR-453-A1	Black with brass sleeve	1	48*
		R393310	MR-453-A126	Black with chrome sleeve	1	48*
		R393315	MR-453-A4	White with brass sleeve	1	48*
		R393320	MR-453-A426	White with chrome sleeve	1	48*
		R393325	MR-453-A2	Almond with brass sleeve	1	48*
		R393330	MR-453-A226	Almond with chrome sleeve	1	48*
						
*May Be Assorted For Volume Quantity.						

FAUCET AERATORS

			CAT. NO.	MFG. NO.	DESCRIPTION	BOX QTY.	VOL. QTY.
STANDARD FAUCET AERATORS							
			R393500	100-K	Female 55/64" x 27 thrds.	12	48*
R393500	R393600	R393700	R393510	100-KPB	Female 55/64" x 27 thrds. Polished Brass	6	48*
			R393600	100-M	Male 15/16" x 27 thrds.	12	48*
	R393705		R393610	100-MPB	Male 15/16" x 27 thrds. Polished Brass	6	48*
			R393700	100-MK	Dual thrds. (Same thrds. as 100K & 100M) Std. thrds.	12	48*
R393800	R393900		R393705	100MK	Tube aerator. Standard dual thread 5/16" x 27 2.2 G.P.M. (6 per tube)	1	6 tube tubes
			R393710	100-MKPB	Dual thrds. (Same thrds. as 100K & 100M) Std. thrds. Polished Brass	6	48*
R393920			R393800	200-K	Female thrds. (Kohler, P.Pftr.c etc.) 3/4" x 27 thrds.	12	48*
			R393810	200-KPB	Female thrds. (Kohler, P.Pftr.c etc.) 3/4" x 27 thrds. Polished Brass	6	48*
	R393925		R393900	200-M	Male 13/16" x 27 thrds.	12	48*
			R393910	200-MPB	Male 13/16" x 27 thrds. Polished Brass	6	48*
R394000	R394100	R394200	R393920	12056-1	Female 13/16" x 24 thrds. 2.0 G.P.M. (Chic. Faucets)	12	48*
			R393925	12057	Tube of Aerators (R393920) 13/16" x 24 Female (5 per tube)	1	6 tube tubes
R394400	R394500		*May Be Assorted For Volume Quantity.				
STANDARD WITH ADAPTERS							
			R394000	102K	Female (thrds. inside of aerator) thrd. for 3/4" hose	6	12
R394600	R394700	R394800	R394100	103K	Male (thrds. outside of aerator) 11/16" x 27 thrds. (Chic. Faucets)	6	12
			R394200	104K	Female (thrds. inside of aerator) 13/16" x 24 thrds. (Chic. Faucets)	6	12
R394900			R394400	106K	Male thrds 3/8" I.P.S. (Youngstown, Schiable Milw., etc.)	6	12
			R394500	108K	Male thrds. 9/16" x 24 thrds. (Crane, Embassy Sterling S-100, etc.)	6	12
			R394600	109K	Male thrds. 5/8" x 18 thrds. (Kohler, Briggs, etc.)	6	12
			R394700	110K	Male thrds. 5/8" x 24 thrds. (Some Elizer, etc.)	6	12
			R394800	111K	With female dual adapter for large outside threaded faucets. Threaded for washing machines and dishwasher hose connections 55/64" x 27 thrds. to 3/4" hose.	6	12
			R394900	111M	With male dual adapter for large inside threaded faucets. Same features as 111K 15/16" x 27 thrds. to 3/4" hose plus a 55/64" x 27 thrds. - male	6	12

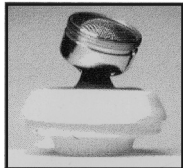
RICHARD SPECIALTY CO., INC.

FAUCET AERATORS		CAT. NO.	MFG. NO.	DESCRIPTION	BOX QTY.	VOL. QTY.		
		STANDARD WITH ADAPTERS						
R395000	R395200	R395000	112K	Female thrds. 1/4" I.P.S. (Misc. Faucets)	6	12		
		R395200	114K	Male thrds. 11/16" x 24 thrds. (Some Crane, Embassy, etc.)	6	12		
		R395400	116K	Male thrds. 1/4" I.P.S. (Misc. Faucets)	6	12		
		R395500	117K	Female thrds. 1/2" I.P.S. (Misc. Faucets)	6	12		
		R395600	211M	Aerator with dual adapter for small 13/16" x 27 thrds. Fits inside threaded faucets. Adapter portion fits 3/4" garden hose.	6	12		
R395500	R395600	UNIVERSAL FIT AERATORS						
			R395700	300K	With universal slip over adapter	6	12	
R395700	R395800	R395900	R395800	301K	Deluxe 300K-Extra sleeve and hose thrd.	6	12	
			R395900	307K	With universal internal expansion POS-A-GRIP adapter. Stainless steel jaws - 2 extra sleeves	6	12	
			R396000	308K	With universal internal expansion adapter - 2 extra sleeves	6	12	
			SWIVEL AERATORS					
			R396200	400K	Female (thrds. inside of aerator) Std. thrds.	6	12	
R396200	R396300	R396400	R396300	400M	Male (thrds. outside of aerator) Std. thrds.	6	12	
			R396400	400MK	Dual thrds. (same thrds. as 400K & 400M) Std. thrds.	6	12	
		SWIVEL SPRAY						
R396500	R396550	R396500		215 Dual thrds.-White	6	12		
		R396550		216 Dual thrds.-Chrome	6	12		

FAUCET ADAPTERS

CAT. NO.

MFG. NO.

DESCRIPTION

BOX QTY. VOL. QTY.

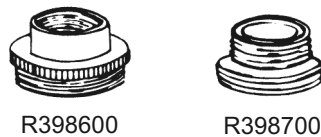
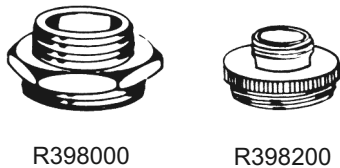
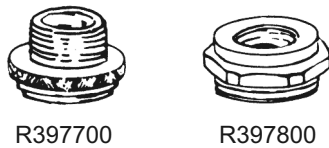
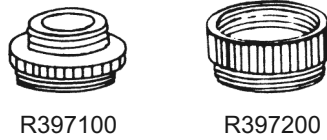
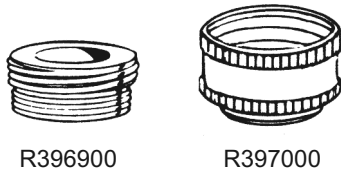

EXACT FIT ADAPTERS







R396900	1M	Male adapter 15/16" x 27 thrs. (Delta, Am.Std., etc.)	6	12
R397000	2K	Female adapter 3/4" Garden Hose	6	12
R397100	3K	Male adapter 11/16" x 27 thrs. (Chicago Faucets)	6	12
R397200	4K	Female adapter 13/16" x 24 thrs. (Chic. Faucets)	6	12
R397400	6K	Male adapter 3/8" I.P.S. (Youngstown, Schiabe, Milwaukee, etc.)	6	12
R397500	8K	Male adapter 9/16" x 24 thrs. (Crane, Embassy, Sterline S-100)	6	12
R397600	9K	Male adapter 5/8" x 18 thrs. (Kohler, Briggs, etc.)	6	12
R397700	10K	Male adapter 5/8" x 24 thrs. (Some Eljier, etc)	6	12
R397800	12K	Female adapter 1/4" I.P.S. (Misc. faucets)	6	12
R398000	14K	Male adapter 11/16" x 24 thrs. (Some Crane, Embassy, etc.)	6	12
R398200	16K	Male adapter 1/4" I.P.S. (Misc. faucets)	6	12
R398300	17K	Female adapter 1/2" I.P.S. (Misc. faucets)	6	12
R398400	20K	Female adapter 3/4" x 27 thrs. (Pri Pfstr-Kohler)	6	12
R398500	20M	Male adapter 13/16" x 27 thrs. (Kohler, Union, Savoy, etc.)	6	12
R398600	27K	Female adapter 1/2" x 27 thrs. (Misc. faucets)	6	12
R398700	28K	Male adapter 5/8" x 27 thrs. (Misc. faucets)	6	12

UNIVERSAL FIT ADAPTERS





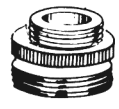





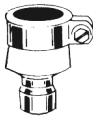
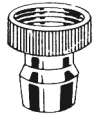

R398800	50K	Universal slip over adapter	6	12
R398900	52K	Universal slip over adapter 2 sleeves - Middle sect. for 3/4" hose, lower for std. aerator	6	12
R399000	53K	Deluxe 50K - 1 extra sleeve	6	12



RICHARD SPECIALTY CO., INC.





FAUCET ADAPTERS		CAT. NO.	MFG. NO.	DESCRIPTION	BOX QTY.	VOL. QTY.
		R399500	R399600			
		R399700	R399800			
		R399900	R400000			
		R400100	R400100			

GARDEN HOSE ADAPTERS



R399500	80K	Female adapter 55/64" x 27 thrs. - Middle section threaded for 3/4" hose - Lower threaded Standard.	6	12
R399600	80M	Male adapter 15/16" x 27 thrs. - Middle and lower sections same as 80K.	6	12
R399700	81K	Female adapter same as 80K less lower section.	6	12
R399800	81M	Male adapter same as 80M less lower section.	6	12
R399900	81MK	Dual thread - male and female - threaded for 3/4" hose only.	6	12
R400000	82M	Male adapter 13/16" x 27 thrs. - Lower section threaded for 3/4" hose.	6	12
R400100	85K	Universal Slip over adapter - Lower section 3/4" hose only.	6	12

SNAP FITTINGS		CAT. NO.	MFG. NO.	DESCRIPTION	BOX QTY.	VOL. QTY.
		R400200		UNIVERSAL FIT SNAP FITTINGS Universal slip over Style. (Non-aerated)	6	12
		R400400	R400500	WITHOUT BUILT-IN AERATOR SNAP FITTINGS Female (threads inside of fitting) Standard threads.	6	12
		R400600	R400900	Male (threads outside of fittings) (Am. Std., Briggs, Crane, Delta, Kohler, Repcal, Speakman)	6	12
		R400600		Dual threads (Same threads as 1200K & (1200M) Standard threads.	6	12
		R401100		Female thrs. - for 3/4" garden hose & bib type faucets.	6	12
		R401600	R401700	Female (threads inside of fitting) 13/16" x 24 thrs. (Chicago Faucets)	6	12
		R401600		Dual threads - Std. large Snap Fitting - Fits std. Male and Female faucets.	6	12
		R401700		Same as 1280MK except with aerator.	6	12

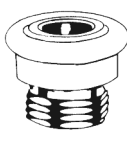
SNAP FITTINGS		CAT. NO.	MFG. NO.	DESCRIPTION	BOX QTY.	VOL. QTY.
WITH BUILT-IN AERATOR SNAP FITTINGS						
		R403000	1380K	Female (inside of fitting) Std. thrds. - Std. large snap fitting.	6	12
R403000	R403500	R403500	1383K	Female (threads inside of fitting) Fits garden hose type faucets.	6	12

SNAP COUPLERS WITH FEMALE RECEPTICAL FOR SNAP FITTINGS		CAT. NO.	MFG. NO.	DESCRIPTION	BOX QTY.	VOL. QTY.
			R404100	1430	With 100M Aerator for all std. small snap fittings.	6 12
R404100	R404200	R404400	R404200	1431K	Same as 1430 except without male aerator.	6 12
			R404400	1433	Snap coupler of 1/2" I.P.S. thrds. for all std. small snap fittings. Fits std. portable European type hand held showers.	6 12
			R404500	1434	Snap coupler with .420 dia. Barbs for use with 15/16" tubing.	6 12
R404500	R404600	R404700	R404600	1435	Snap coupler with 3/4" male hose-thrd.-For all std. small snap fittings.	6 12
			R404700	1485	Snap coupler with 3/4" male hose thrd.-For all std. large snap fittings.	6 12

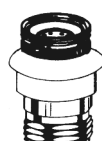
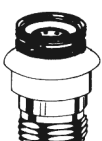
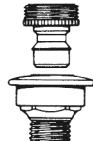
SNAP COUPLER SETS

			R404800	1530	Coupler set for sill cock and garden hose snap action.	6 12
R404800	R404900	R405000	R404900	1531	Coupler set for in & outside thread faucets. (Combines 1200MK & 1435)	6 12
			R405000	1532	Deluxe Set-same as 1531, but with aerated snap fitting. (Combines 1300MK & 1435)	6 12
			R405100	1533	Deluxe Set-for in & outside thread faucets. (Combines 1300MK & 1433)	6 12
R405100	R405200		R405200	1581	Deluxe Set-with aerated snap fittings for in or outside threaded faucets. (Combines 1380MK & 1485)	6 12

RICHARD SPECIALTY CO., INC.

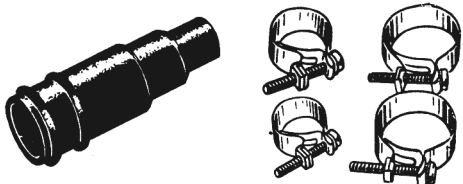

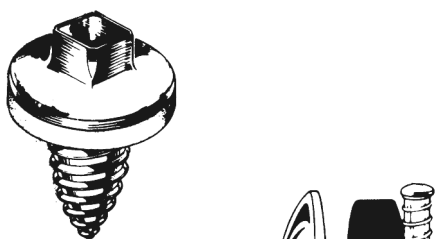
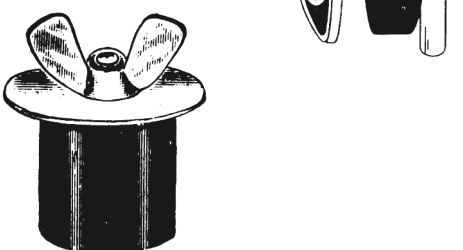

CONNECTOR KIT		CAT. NO.	MFG. NO.	DESCRIPTION	BOX QTY.	VOL. QTY.
		R406100	GDK-2B	DISHWASHER / DISPOSER CONNECTOR Makes easy connection between dishwasher drain and disposal. Clamps furnished.	1	12

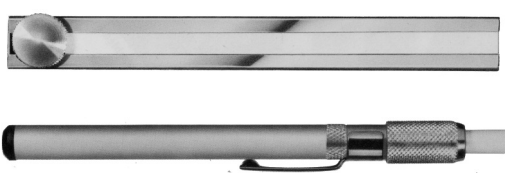
FREE-ALL TOOL		CAT. NO.	DESCRIPTION	BOX QTY.	VOL. QTY.
		R406200	GARBAGE DISPOSER TOOL Frees Jammed Disposals. For releasing jammed garbage disposers, 1/2" steel, 10" long.	1	6



BOILER REPAIR PLUGS		CAT. NO.	SIZE	DESCRIPTION	BOX QTY.	VOL. QTY.
		R406300	1/4"	SELF-TAPPING REPAIR PLUGS For Boilers, Radiators, Pipes and Tanks. Hardened Steel, Neoprene Washer, Self-tapping.	1	50*
		R406400	5/16"	Washer, Self-tapping.	1	50*
		*May Be Assorted For Volume Quantity.				
		R406900	1 1/2" Plate	THE TOGGLE BAR BOILER REPAIR PLUG HARDENED STEEL, CADMIUM PLATED Regular size plug (12-cd.)	1cd	6cd
		TRAP PLUGS-RUBBER				
		R407010		12 Assorted Plugs to Display Card	1cd	2cd
		R407020	3/4"	12 Small Plugs to Display Card	1cd	2cd
		R407030	7/8"	12 Medium Plugs to Display Card	1cd	2cd
		R407040	1 1/8"	12 Large Plugs to Display Card	1cd	2cd

SOAPSTONES AND HOLDERS		CAT. NO.	SIZE	DESCRIPTION	BOX QTY.	VOL. QTY.
		R407100		FLAT AND ROUND SOAPSTONES AND HOLDERS Flat Soapstone Holder	1	24
		R407200	5" x 1/2" x 3/16"	Flat Soapstone	(1 gr.) 144	(3 gr.) 432
		R407300		Round Soapstone Holder	1	24
		R407400	5" x 1/4"	Round Soapstone	(1 gr.) 144	(3 gr.) 432

LUMBER CRAYON		CAT. NO.	SIZE	DESCRIPTION	BOX QTY.	VOL. QTY.
	R407405	4 3/4" x 1/2"	Hex yellow	1 dz.	6 dz.	
	R407410	4 3/4" x 1/2"	Hex white	1 dz.	6 dz.	
	R407415	4 3/4" x 1/2"	Hex red	1 dz.	6 dz.	
	R407420	4 3/4" x 1/2"	Hex black	1 dz.	6 dz.	

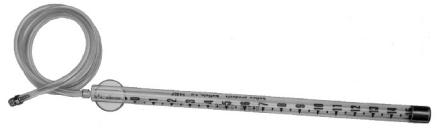
SEWER STOPS		CAT. NO.	SIZE	DESCRIPTION	BOX QTY.	VOL. QTY.
SINDELL SEWER STOPS						
 <p>V-Style</p>	R407480	2-V	2"	Plated Steel w/float valve	1	12*
	R407500	3-V	3"	Plated Steel w/float valve	1	12*
 <p>R408100</p>	R407600	4-V	4"	Plated Steel w/float valve	1	12*
	*May Be Assorted For Volume Quantity.					
 <p>R408110 R408120</p>	R407700	2-VBQ	2"	Brass w/float valve	1*	12**
	R407800	3-VBQ	3"	Brass w/float valve	1*	12**
	R407900	4-VBQ	4"	Brass w/float valve	1*	12**
	R408100	3470	4"	Plastic body for 1 1/2" standpipe	1	12*
 <p>R408110</p>	R408110	3480	4"	Plastic body - Universal with float and for 1 1/2" standpipe	1	12*
	R408120	3481	3"	Plastic Body - Universal with float and for 1" standpipe	1	12*
* May Be Assorted For Volume Quantity. **Check Price Sheet For Volume Quantity.						

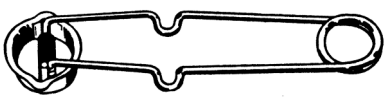
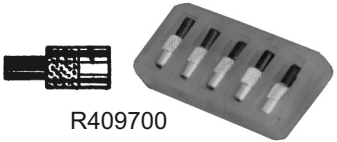
GAUGE		CAT. NO.	SIZE	DESCRIPTION	BOX QTY.	VOL. QTY.
GAUGE MEASURES GAS PRESSURE						
Ideal for Heating and Air Conditioning Servicemen						
	R408200	7 1/2"	Water Column	1	12*	
	R408300	15"	Water Column	1	12*	
* May Be Assorted For Volume Quantity.						

LIGHTERS & FLINTS		CAT. NO.	DESCRIPTION	BOX QTY.	VOL. QTY.
LIGHTERS					
	R409600	Overall length 8 inches. Single flint spark lighter. Bright zinc iridite plated for corrosion resistance.	(1)10	20	
FLINTS					
 <p>R409700</p>	R409700	Flints fit R409600 lighters. 5 flints per package. 40 packages per box.	(1pk.) 40pk	40pk	
 <p>R409850</p>	R409800	Three flint lighter	(1)10	20	
	 <p>R409800</p>	R409850	Three flint renewal	(1)50	50

RICHARD SPECIALTY CO., INC.

SHEET METAL TOOLS

CAT. NO.	MFG. NO.	DESCRIPTION	BOX QTY.	VOL. QTY.
----------	----------	-------------	----------	-----------

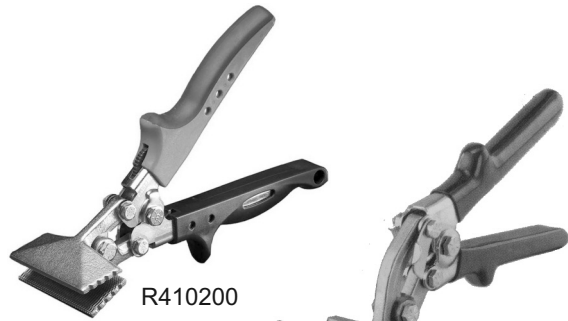

HAND SEAMER

R410200	S-2R	Bends and flattens metal easily. Makes tight fitting seams. 1/4" scale on jaws. Black grips	1	2
---------	------	---	---	---



R410210	S-3R	Like S-2 offset handle	1	2
---------	------	------------------------	---	---



R410220	S-6R	6" wide jaws	1	2
---------	------	--------------	---	---

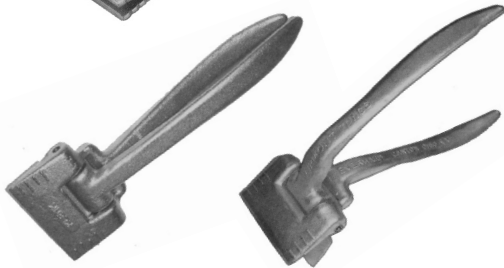

FAIRMONT TONGS

R410230		Straight Tongs	1	2
---------	--	----------------	---	---

R410235		Straight Tongs w/grips	1	2
---------	--	------------------------	---	---

R410240		Offset Tongs	1	2
---------	--	--------------	---	---

R410245		Offset Tongs w/grips	1	2
---------	--	----------------------	---	---

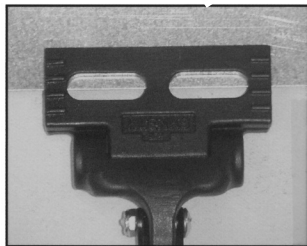

R410250		Seamer w/view slot	1	2
---------	--	--------------------	---	---

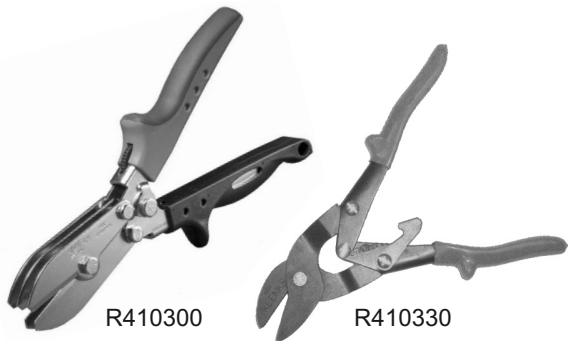

HAND CRIMPER (DOUBLE)

R410300	C-5R	For all round, square and corrugated pipe. 1 5/8" deep crimps. Red grips	1	4
---------	------	--	---	---

R410320		Crimper 1 5/8" Deep Crimps	1	4
---------	--	----------------------------	---	---

R410330		Offset 45° 1 5/8" Deep Crimps	1	4
---------	--	-------------------------------	---	---



SINGLE CRIMPER

R410400		A "MUST" for plumbers when installing vent pipes on gas hot water heaters and similar jobs	1	6
---------	--	--	---	---

SHEET METAL TOOLS

	CAT. NO.	MFG. NO.	DESCRIPTION	BOX QTY.	VOL. QTY.
--	----------	----------	-------------	----------	-----------

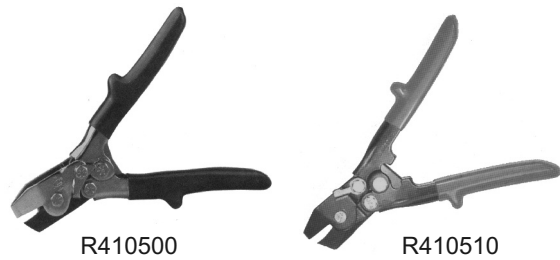

HAND NOTCHER

R410500	N-1R	Spring return action. Notches 31° angle 13/16" deep	1	4
R410510		30° Notch Cut	1	4

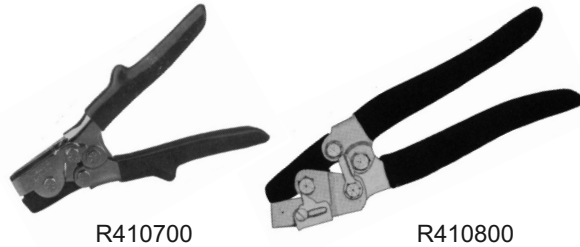

SNAP LOCK PUNCHES

R410700	SL-1R	Joins sheet metal, duct and pipe sections. Punch impressions spaced 3/8" from edge of metal. Green grips	1	2
R410800	SL-2R	Side adjustment for throat depth allows setting from 1/4" to 5/8" depth. Green grips	1	2

PIPE AND DUCT HOLDER

R410900	2-DH	2 powerful clamps and 4 feet of strong chain	1	2
---------	------	--	---	---

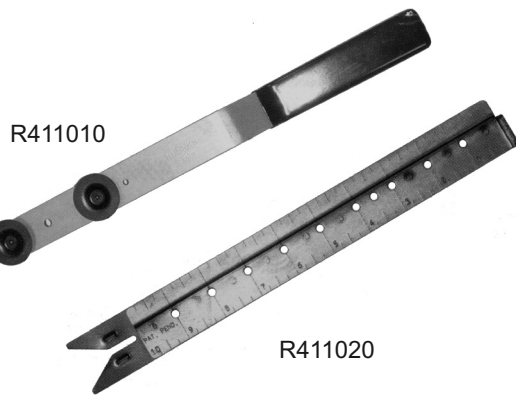

DUCT STRETCHER

R411000	DS-1	Pulls square duct together with easy rolling motion. Wheels can be switched for reverse motion	1	2
R411010		16" long with offset handle	1	2
R411020		Combo Drive Tool (Duct Puller, Folding Tool, Scribe and Ruler)	1	2



DUCT SLICER

R411030		12" Duct Slicer	1	2
---------	--	-----------------	---	---



ALUMINUM FOLDING TOOLS





R411200	No.12	Length 12". Folds 3/8" & 1" depths	1	2
R411210	No.18	Length 18" Same features as above	1	2
R411220	No.24	Length 24" Same features as R411200	1	2



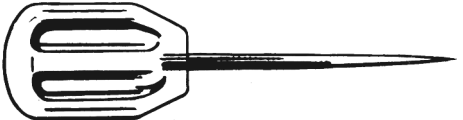

DIVIDERS

R411300	No.18	For circles up to 36" Scribes thin accurate line. Scratch awe prints are easily resharpened or replaced.	1	2
R411400	No.24	For circles up to 48" Same features as above.	1	2

RICHARD SPECIALTY CO., INC.

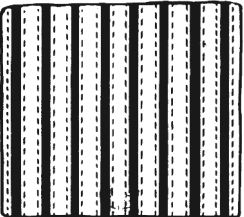
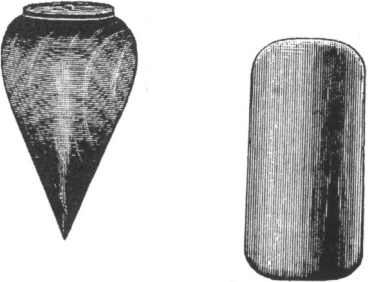
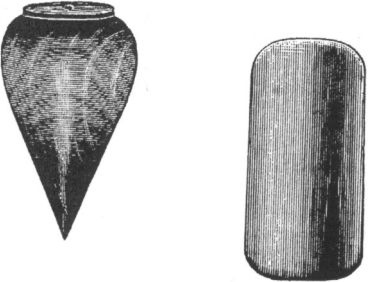
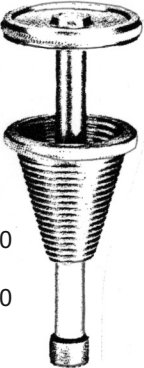
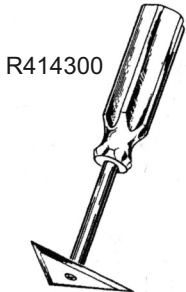
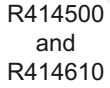
SHEET METAL TOOLS		CAT. NO.	MFG. NO.	DESCRIPTION	BOX QTY.	VOL. QTY.
SCRATCH AWLS & TIP SCRIBERS						
	R411820			Double pointed scriber	1	6
SCRATCH AWLS						
	R411900	257		1/4" round blade x 4" Overall length 7 1/4" For piercing holes in sheet metal For scribing and layout work	1	6
	R412000	255		1/8" round blade x 3" Overall length 5" Small compact tool	1	6
	R412100	#1	2 1/2"		1	12
	R412200	#2	3 1/2"		1	12
	R412300	#3	4 1/2"		1	6
	R412400	#4	5 1/2"		1	6

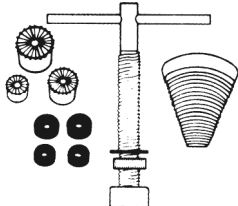
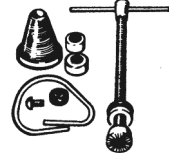
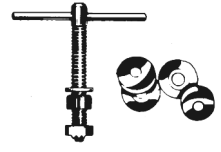
LEAD WORKING TOOLS		CAT. NO.	MFG. NO.	SIZE	BOX QTY.	VOL. QTY.
FORMED SOLDER WIPING CLOTHS						
Heavy duty ticking						
	R413100			3" x 3"	1	24
	R413300			3 1/2" x 3 1/2"	1	24
	R413400			4" x 4"	1	24
FLAT FINISHED CATCH CLOTHS						
	R413405			5" x 5"	1	6
	R413410			6" x 6"	1	6
	R413415			6" x 7"	1	6
	R413425			8" x 8"	1	6
	R413430			10" x 10"	1	6
TURN PINS Quality Hardwood						
	R413500			2 1/4"	1	12
	R413700			2 3/4"	1	12
DRIFT PLUGS Quality Hardwood						
	R414000			1 1/2"	1	12
PLUMBERS SCRAPER						
	R414300	304		Furnished with oval blade Extra sharp blades Easily changes	(1)12	24
BIBB SEAT DRESSER						
	R414500	6170		6 bevelled cutters 1/2", 9/16", 11/16", 13/16", 29/32", 1" O.D.	1	2
	R414610	4170-L		4 flat cutters 1/2", 5/8", 3/4", 7/8" O.D., shank 8" overall	1	2

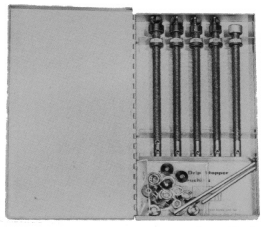
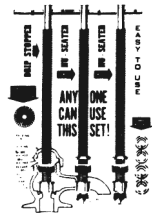
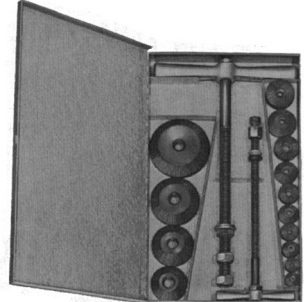
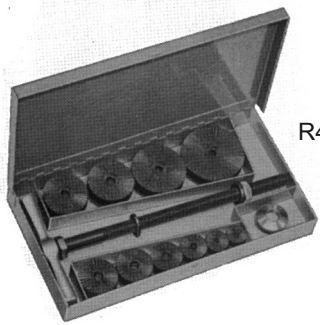
LEAD WORKING TOOLS		CAT. NO.	MFG. NO.	DESCRIPTION	BOX QTY.	VOL. QTY.
BIBB SEAT DRESSER						
	R414700	R414700	43	Standard Type w/guide cone 1/2", 9/16", 5/8", 3/4" cutters	1	6
	R414705	R414705	31	Long Stem Type w/guide cone 1/2", 9/16", 5/8", 3/4" cutters	1	6
	R414710	R414710	15	Standard with 1/2", 9/16", 5/8" cutters	1	6
	R414715	R414715	8	Bevelled with 9/16", 5/8" cutters	1	6
	R414720	R414720	7	NuSeater & Drip Stopper Set in Metal box	1	2
	R414725	R414725	11	NuSeater Sets 1/4" to 1/2" faucets	1	6
FAUCET AND VALVE REPAIR SET						
	R414730	R414730	5	Flat size cutters from 1/4" to 2" Conical cutters to reface plug or ball type valves from 1/4" to 2" - 45°. Used by plumbers, building engineers and industrial maintenance men. Metal case. Cutter sizes 9/16" O.D. to 2 5/8" O.D.	1	2
	R414735	R414735	6	For refacing wash basin, tub and shower faucet seats from 1/4" to 78". For refacing Jenkins-type disc. valve seats from 1/4" to 1 1/4". Includes 10 flat-surface cutting heads from 9/16" O.D. to 1 13/16" O.D., stem w/handle, nuts and flat washer, and bevel washer for large faucet openings.	1	2

PLUMBERS CANDLES		CAT. NO.	DESCRIPTION	BOX QTY.	VOL. QTY.
-------------------------	--	----------	-------------	----------	-----------



PLUMBERS CANDLES

R415000	5" long	1	200
---------	---------	---	-----

RICHARD SPECIALTY CO., INC.

MIRRORS AND MAGNETS

CAT. NO.	MFG. NO.	DESCRIPTION	BOX QTY.	VOL. QTY.
----------	----------	-------------	----------	-----------

INSPECTION MIRRORS



R415100	K-2	Inspection mirror with telescoping handle. Length 11 1/4" to 15 1/4" with 2 1/8" x 3 1/2" mirror	1	6
---------	-----	--	---	---



R415105	K-2L	Like K-2. Extra long length 17 1/4" to 27 1/2"	1	6
---------	------	--	---	---



R415110	S-2	Inspection mirror with telescoping handle. Length 11" to 15" with 3 1/4" round mirror	1	6
---------	-----	---	---	---



R415115	S-2L	Like S-2. Extra long length 17 1/4" to 27 1/4"	1	6
---------	------	--	---	---



R415200	C-2	Inspection mirror with telescoping handle. Length 10" to 14 1/2" with 2 1/2" round mirror	1	6
---------	-----	---	---	---

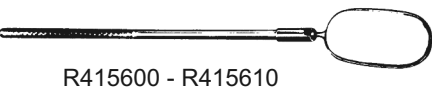

R415210	C-2L	Like C-2. Extra long length 16" to 26"	1	6
---------	------	--	---	---



R415300	E-2	Inspection mirror w/ball joint adjustment. Length 8" with 1 1/4" round mirror	1	6
---------	-----	---	---	---



R415310	E-2T	Like E-2. Extra long length 14"	1	6
---------	------	---------------------------------	---	---

R415400	151	Tilting inspection mirror. Length 16 1/2" with 1 11/16" x 2 9/16" mirror. Full 90° swing tilt	1	6
---------	-----	---	---	---

R415600	B-2	Inspection mirror. Length 9" with 1" x 2" mirror; 360° positioning	1	6
---------	-----	--	---	---

R415610	B-2T	Like B-2. Extra long length 14 1/2"	1	6
---------	------	-------------------------------------	---	---

MAGNIFYING INSPECTION MIRRORS

R415615	K-2M	2 1/8" x 3 1/2" rectangular. Length 11 1/4" to 15 1/4"	1	6
---------	------	--	---	---

R415620	K-2ML	2 1/8" x 3 1/2" rectangular. Length 17 1/4" to 27 1/2"	1	6
---------	-------	--	---	---

R415625	C-2M	2 1/4" round. Length 10" to 14"	1	6
---------	------	---------------------------------	---	---

R415630	C-2ML	2 1/4" round. Length 16" to 26"	1	6
---------	-------	---------------------------------	---	---

R415635	E-2M	1 1/4" round. Length 8"	1	6
---------	------	-------------------------	---	---

R415640	A-2M	7/8" round. Length 7 1/2"	1	6
---------	------	---------------------------	---	---

LED LIGHTED INSPECTION MIRRORS

R415645	HTE-2LT	1 3/8" round mirror. Telescopes 6 1/2" to 35"	1	6
---------	---------	---	---	---

R415650	HTC-2LT	2 3/8" round mirror. Telescopes 6 1/2" to 36 3/8"	1	6
---------	---------	---	---	---

R415655	HTS-2LT	3 3/8" round mirror. Telescopes 6 1/2" to 30 1/4"	1	6
---------	---------	---	---	---

R415660	HTK-2LT	2 1/4" x 3 1/2" rectangular mirror. Telescopes 6 3/4" to 30 1/4"	1	6
---------	---------	--	---	---



R415655

MIRRORS AND MAGNETS



R415670

MAGNIFYING INSPECTION MIRRORS

R415670 LPT-75 LED Lighted magnetic pick up tool telescopes from 6 3/4" to 27 1/2", lifts 7 1/2 lbs. 1 5

R415680 Kit with rectangular mirror and lighted magnetic pick up tool. 1 3

R415685 Kit with round mirror and lighted magnetic pick-up tool. 1 3

R415680 - R415685

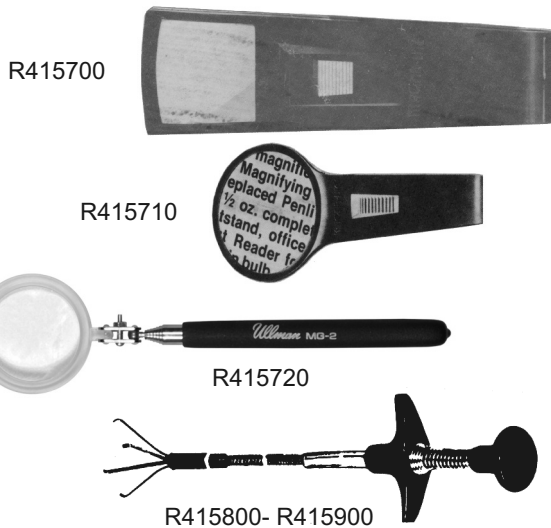

R415700

MAGNA-LITE

R415700 #1001 Flashlight and Magnifiers. (1)12 12

R415710 #2001 Powerful Magnifying Lens with Light. 1 3

R415720 MG-2 Telescoping magnifying glass. 2 3/8" shatter resistant magnifying head 1 6

R415710

R415720

GRABBERS

R415800 14" Grabber 1 6

R415900 24" Grabber 1 6

R415800- R415900

CAT. NO.	MFG. NO.	SIZE	DESCRIPTION	BOX QTY.	VOL. QTY.
----------	----------	------	-------------	----------	-----------

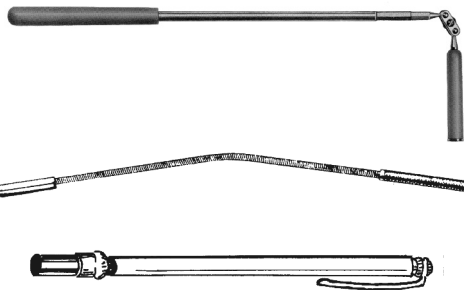

MAGNET PICK-UP TOOL

R416000 694 27" Magnetic pick-up tool 17" extends to 27". 1 6

R416100 794 18" Flexible magnetic pick-up tool. 1 6

R416200 MG18 5 1/4" to 17" Telescoping magnetic pick-up tool with pocket clip 1 12

PILOT LIGHTERS

CAT. NO.	MFG. NO.	SIZE	DESCRIPTION	BOX QTY.	VOL. QTY.
----------	----------	------	-------------	----------	-----------



R416400 BTL-11 5 3/4" to 26" Telescoping pilot lighter with alligator clip. 1 12

FLOOR & CEILING PLATES

CAT. NO.	SIZE I.P.S.	MFG. NO.	CAT. NO.	SIZE I.P.S.	MFG. NO.	CAT. NO.	SIZE I.P.S.	MFG. NO.	BOX QTY.	VOL. QTY.
----------	-------------	----------	----------	-------------	----------	----------	-------------	----------	----------	-----------

PLASTIC - FOR IRON PIPE - I.P.S.

CHROME			WHITE			POLISH BRASS				
R417900	3/8"	30	R417920	3/8"	30W	R417940	3/8"	30PB	12	288*
R417901	1/2"	50	R417921	1/2"	50W	R417941	1/2"	50PB	12	288*
R417902	3/4"	75	R417922	3/4"	75W	R417942	3/4"	75PB	12	288*
R417903	1"	100	R417923	1"	100W	R417943	1"	100PB	12	288*
R417904	1 1/4"	125	R417924	1 1/4"	125W	R417944	1 1/4"	125PB	12	288*
R417905	1 1/2"	150	R417925	1 1/2"	150W	R417945	1 1/2"	150PB	12	288*
R417906	2"	200	R417926	2"	200W	R417946	2"	200PB	12	288*
R417907	2 1/2"	250	R417927	2 1/2"	250W	R417947	2 1/2"	250PB	12	288*
R417908	3"	300	R417928	3"	300W	R417948	3"	300PB	12	288*
R417910	4"	400	R417930	4"	400W	R417950	4"	400PB	12	288*
R417912	5"	500	R417932	5"	500W	R417952	5"	500PB	6	288*
R417913	6"	600	R417933	6"	600W	R417953	6"	600PB	6	288*
R417914	8"	800	R417934	8"	800W	R417954	8"	800PB	6	288*

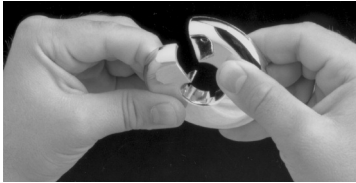

PLASTIC - FOR COPPER WATER TUBE - C.W.T.

CHROME			WHITE			POLISH BRASS				
R417960	1/2"	50C	R417970	1/2"	50CW	R417980	1/2"	50CPB	12	288*
R417961	3/4"	75C	R417971	3/4"	75CW	R417981	3/4"	75CPB	12	288*
R417962	1"	100C	R417972	1"	100CW	R417982	1"	100CPB	12	288*
R417963	1 1/4"	125C	R417973	1 1/4"	125CW	R417983	1 1/4"	125CPB	12	288*
R417964	1 1/2"	150C	R417974	1 1/2"	150CW	R417984	1 1/2"	150CPB	12	288*
R417965	2"	200C	R417975	2"	200CW	R417985	2"	200CPB	12	288*
R417966	2 1/2"	250C	R417976	2 1/2"	250CW				12	288*
			R417977	3"	300CW				12	288*
			R417978	3 1/2"	350CW				12	288*



*May Be Assorted For Volume Quantity.

BELL ESCUTCHEONS - PLASTIC - C.W.T.

R418000	1/2"	3000	R418002	1/2"	3000W	R418004	1/2"	3000PB	25	100
---------	------	------	---------	------	-------	---------	------	--------	----	-----



DEEP BOX ESCUTCHEONS O.D. - PLASTIC

R418025	1 1/4"	3300	R418030	1 1/4"	3300W	R418035	1 1/4"	3300PB	12	72
R418026	1 1/2"	3400	R418031	1 1/2"	3400W	R418036	1 1/2"	3400PB	12	72



SPRINKLER ESCUTCHEONS 2-PIECE I.P.S. - PLASTIC

R418040	1/2"	1000	R418041	1/2"	1000W	R418042	1/2"	1000PB	12	72
---------	------	------	---------	------	-------	---------	------	--------	----	----

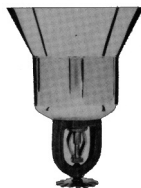

SPRINKLER ESCUTCHEONS 1-PIECE I.P.S. - PLASTIC

R418045	1/2"	2000	R418046	1/2"	2000W	R418047	1/2"	2000PB	12	72
---------	------	------	---------	------	-------	---------	------	--------	----	----



ROD BUTTONS I.P.S. - PLASTIC

R418050	3/8"	4000	R418051	3/8"	4000W	R418052	3/8"	4000PB	100	500
---------	------	------	---------	------	-------	---------	------	--------	-----	-----



FLOOR & CEILING PLATES

CAT. NO.	FOR IRON PIPE I.P.S.	CAT. NO.	FOR COPPER WATER TUBE C.W.T.	BOX QTY.	VOL. QTY.
----------	----------------------	----------	------------------------------	----------	-----------

FLOOR & CEILING PLATES Chrome plated steel

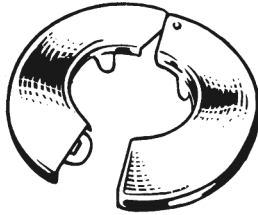

R418100	3/8"	R420100	3/8"	12	72*
R418200	1/2"	R420200	1/2"	12	72*
R418300	3/4"	R420300	3/4"	12	72*
R418400	1"	R420400	1"	12	72*
R418500	1 1/4"	R420500	1 1/4"	12	72*
R418600	1 1/2"	R420600	1 1/2"	12	72*
R418700	2"	R420700	2"	12	72*
R418800	2 1/2"	R420800	2 1/2"	12	72*
R418900	3"	R420900	3"	12	72*
R419000	3 1/2"	-	-	12	72*
R419100	4"	R421100	4"	12	72*
R419300	5"	-	-	1	72*
R419400	6"	-	-	1	72*
R419450	8"	-	-	1	72*
R419455	10"	-	-	1	72*

*May Be Assorted For Volume Quantity.

CAT. NO.	MFG. NO.	SIZE	BOX QTY.	VOL. QTY.
----------	----------	------	----------	-----------

FLANGES CHROME PLATED STEEL

Low pattern height 1/2", base 2 1/2"



R421500	AA-10	3/8" I.P.S.	50	200
R421600	AA-20	1/2" I.P.S.	50	200
R421700	AA-31	3/4" I.P.S.	50	200
R421800	AA-12	3/8" O.D.	50	200
R422000	AA-16	1/2" O.D.	50	200
R422200	AA-18	5/8" O.D.	50	200
R422400	AA-22	7/8" O.D.	50	200
R422700	AA-24	1 1/8" O.D.	50	200

CHROME PLATED STEEL

Low pattern height 5/8", base 2 7/8"



R422800	AA-33	3/4" I.P.S.	50	200
R422900	AA-34	1" I.P.S.	50	200
R423000	AA-37	1 1/4" I.P.S.	25	200
R423100	AA-41	1 1/2" I.P.S.	25	200
R423200	AA-80	1 1/4" O.D.	50	200
R423300	AA-90	1 3/8" O.D.	50	200
R423400	AA-100	1 1/2" O.D.	25	200
R423500	AA-102	1 5/8" O.D.	25	200

CHROME PLATED STEEL

Low pattern height 3/4", base 3 1/2"



R423800	AA-45	2" I.P.S.	25	200
R424000	AA-110	2" O.D.	25	200

CHROME PLATED STEEL

Small deep bell, height 1 1/4", base 2 3/8". For supply installations.



R424100	AA-160	3/8" I.P.S.	25	100
R424200	AA-170	1/2" I.P.S.	25	100
R424300	AA-175	3/4" I.P.S.	25	100
R424400	AA-180	3/8" O.D.	25	100
R424600	AA-190	1/2" O.D.	25	100
R424800	AA-202	5/8" O.D.	25	100
R425100	AA-210	3/4" O.D.	25	100
R425200	AA-212	1" O.D.	25	100

RICHARD SPECIALTY CO., INC.

FLOOR & CEILING PLATES

CAT. NO.	MFG. NO.	SIZE	BOX QTY.	VOL. QTY.
----------	----------	------	----------	-----------

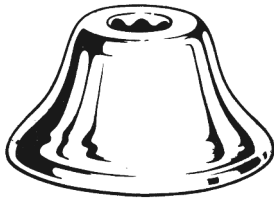

CHROME PLATED STEEL

Large deep bell height 1 5/16" base 3". For trap installations.

R425500	AA-240	1 1/2" I.P.S.	25	200
R425600	AA-220	1 1/4" O.D.	25	200
R425800	AA-230	1 1/2" O.D.	25	200



CHROME PLATED STEEL

High box flanges height 1 3/4", base 3"

R425900	AA-242	1 1/4" O.D.	1	100
R426000	AA-244	1 1/2" O.D.	1	100
R426100	AA-246	2" O.D.	1	100
R426200	AA-243	1 1/4" I.P.S.	1	100
R426300	AA-245	1 1/2" I.P.S.	1	100

SPLIT-ONE™

P-TRAPS - PLASTIC

CAT. NO.	MFG. NO.	SIZE	BOX QTY.	VOL. QTY.
----------	----------	------	----------	-----------

R426400 - R426700

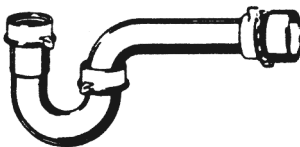

CHROME FINISH

R426400	707 (813-C)	1 1/4"	1	36
R426500	708	1 1/2"	1	36

BRASS FINISH

R426600	709 (813-PB)	1 1/4"	1	36
R426700	711	1 1/2"	1	36

FLEXI-DRAINS

R426800		1 1/4"-1 1/2" J-bend trap.	1	12
---------	--	----------------------------	---	----

R426805		1 1/4"-1 1/2" J-bend trap with adapter.	1	12
---------	--	---	---	----

R426810		Connector, Coupler, Elbow.	1	12
---------	--	----------------------------	---	----

R426815		1 1/4" x 8" Direct thread pop-up, drain tailpiece.	1	12
---------	--	--	---	----

R426820		1 1/4" x 9" Slip Joint extension with nut & washer.	1	12
---------	--	---	---	----

R426825		1 1/2" x 12" Slip Joint extension with nut & washer.	1	12
---------	--	--	---	----

R426830		1 1/2" x 12" Flanged tailpiece with nut & washer.	1	12
---------	--	---	---	----



R426805

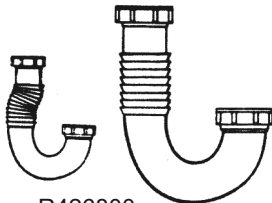
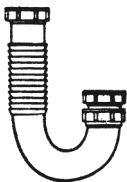

R426800



R426810

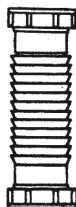

R426820		1 1/4" x 9" Slip Joint extension with nut & washer.	1	12
---------	--	---	---	----

R426825		1 1/2" x 12" Slip Joint extension with nut & washer.	1	12
---------	--	--	---	----

R426830		1 1/2" x 12" Flanged tailpiece with nut & washer.	1	12
---------	--	---	---	----



R426815



R426820 - R426825

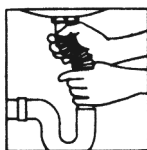

R426830

SPECIALTY FITTINGS	CAT. NO.	SIZE	BOX QTY.	VOL. QTY.
---------------------------	----------	------	----------	-----------



CUSTOM PIPING PRODUCTS

R426850	2" x 1.5" Slip joint double Wye	1	10
---------	---------------------------------	---	----

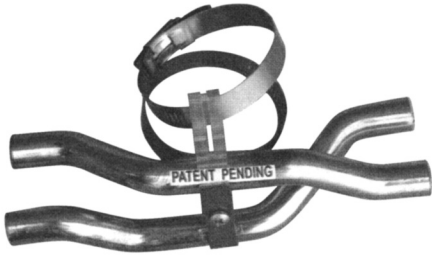

R426855	Back to back hot & cold water fitting	1	10
---------	---------------------------------------	---	----

SHOWER ARMS	CAT. NO.	MFG. NO.	SIZE	BOX QTY.	VOL. QTY.
--------------------	----------	----------	------	----------	-----------

SHOWER ARMS Chrome plated brass.



R427000	AA-6A	1/2" x 6"	1	12
R427100	AA-8A	1/2" x 8"	1	12
R427200	AA-10A	1/2" x 10"	1	6



"S" STYLE SHOWER ARM

R427230	8" "S" Style Arm	1	6
R427240	10" "S" Style Arm	1	6

FAUCET HOLE COVERS	CAT. NO.	MFG. NO.	SIZE	BOX QTY.	VOL. QTY.
---------------------------	----------	----------	------	----------	-----------



HOLE COVERS with Stainless steel tops.

R427300	AA-243-S	1 3/4"	25	100
R427350	AA-236	2"	25	100
R427360	AA-238	3"	25	100

BASIN WASHERS	CAT. NO.	MFG. NO.	SIZE	BOX QTY.	VOL. QTY.
----------------------	----------	----------	------	----------	-----------

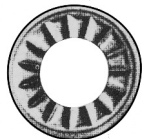

BASIN WASHERS

R427400	AA-78	7/8" I.D. x 1 3/4" O.D.	100	200
---------	-------	-------------------------	-----	-----

RICHARD SPECIALTY CO., INC.

DIE CAST SLIP NUTS

CAT.
NO.SIZE
I.P.S. X TUBEBOX VOL.
QTY. QTY.

DIE CAST SLIP NUTS-BURNISHED CHROME

(less washers)



R427600	1 1/4" x 1 1/4"	1	500
R427650	1 1/4" x 1 3/8"	1	500
R427700	1 1/2" x 1 1/4"	1	500
R427800	1 1/2" x 1 3/8"	1	500
R427900	1 1/2" x 1 1/2"	1	500
R428000	2" x 2"	1	300
R428050	2" x 1 1/2"	1	300



SLIP NUT WASHERS - Rubber

R428610	1 1/4" x 1 1/4"	100	500
R428620	1 1/2" x 1 1/4"	100	500
R428630	1 1/2" x 1 1/2"	100	500
R428632	2" x 2"	100	500



SLIP NUT WASHERS - Poly

R428640	1 1/4" x 1 1/4"	100	500
R428642	1 1/2" x 1 1/4"	100	500
R428644	1 1/2" x 1 1/2"	100	500
R428646	1 1/2" Tailpiece	100	500

CAT.
NO.SIZE
I.P.S. X TUBEBOX VOL.
QTY. QTY.

NO PUTTY GASKETS

R428650	P2KG01 Sink & Shower	10	100
R428655	P2KG02 Lav. & Hose Spray	10	100
R428660	P2KG03 Tub, Laundry & Bar Sink	10	100

CAT.
NO.SIZE
BRASS COLLARBOX VOL.
QTY. QTY.

MALE-WASTE CONNECTORS

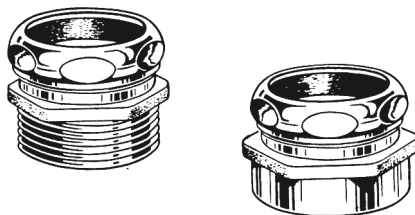

R428700	1 1/4" x 1 1/4"	1	12
R428800	1 1/2" x 1 1/2"	1	12
R428900	1 1/2" x 1 1/4"	1	12

FEMALE-WASTE CONNECTORS

R429000	1 1/4" x 1 1/4"	1	12
R429100	1 1/2" x 1 1/2"	1	12
R429200	1 1/2" x 1 1/4"	1	12

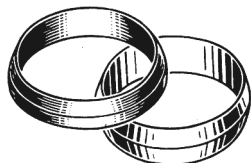

SLIP COLLARS

BRASS RING

R429500	1 1/4"	1	-
R429600	1 1/2"	1	-

KNIVES	CAT. NO.	MFG. NO.	DESCRIPTION	BOX QTY.	VOL. QTY.
	R430500	4046	UTICA KNIVES 4-blade camp knife stag. 3 3/8" Riveted shackle. Spear, can opener, punch/awl, screwdriver & bottle opener.	1	6
	R430600	2558	ELECTRICIAN'S KNIFE 3 3/4" Rosewood handle. Wire scraper blade locks open. Spear blade, screwdriver and insulation cutter.	1	6
	R430800	151804	LINEMAN'S KNIFE For skinning, linoleum and pruning. 4 1/4" knife with rosewood handle.	1	6
	R430900	247472	UTICA'S GENUINE BARLOW - Old favorite 3 1/4" Clip and pen blades. Scored tough handles. Solid steel bolsters with "Barlow" stamped both sides.	1	6
	R431000	3256	PREMIUM STOCK 3 7/8" Master clip, spey and sheepfoot blades.	1	6
	R431200	2406	SMALL EQUAL END JACK 2 7/8" Clip and pen blades.	1	6
	R431300	2256	SKINNER'S AND TRAPPER'S 3 7/8" Two skinning clip blades.	1	6
	R431330	1385	5 in 1 Multi knife with 5 1/2" adjustable wrench, spear blade, 2 slotted, 1 phillips screwdriver, cap lifter and file.	1	6
	R431335	11-3565	15 in 1 Function Tool. Includes pliers, bevelled wire cutter, gripper, coarse & fine sided file, wave edge sheepfoot blade, metric/std. ruler, saw blade, clip blade, 2 1/4" screwdriver bits (2 phillips, 2 slotted), universal can/bottle opener & nylon belt pouch.	1	6

KNIVES	CAT. NO.	MFG. NO.	DESCRIPTION	BOX QTY.	VOL. QTY.
 R431600			SCHRADE OLD TIMER KNIVES Genuine saw cut, Staflon Handles.		
	R431600	80T	4" Senior	1	6
 R432000			SCHRADE OLD TIMER KNIVES Genuine saw cut, Staglon Handles.		
	R432000	340T	3 5/16" Middleman	1	6
 R432100					
	R432100	70T	5" Lock back Big Timer with sheath	1	6
 R432200					
	R432200	940T	3 7/8" Gunstock trapper	1	6
 R432900					
	R432900	1520T	7 1/4" Sharp Finger with 2 1/2" hand glazed skinning blade. Steerhide sheath.	1	6
 R433000					
	R433000	1580T	7 3/4" Drop Point Hunter 3 1/2" gutting and skinning blade. Top grain leather sheath.	1	6
 R434000			SCHRADE - UNCLE HENRY		
	R434000	LB7	5" Bear Paw Locks when open. 3 1/2" blade. "Wonda Wood" handle. Leather sheath.	1	6
 R434100					
	R434100	285UH	3 7/8" Pro-Trappers	1	6
 R434200					
	R434200	885UH	4" King Ranch	1	6
 R434300			SCHRADE - UNCLE HENRY		
	R434300	897UH	3 9/16" Signature Premium Stock	1	6
 R434700					
	R434700	153UH	9 1/4" Golden Spike with 4 1/2" blade. Comes with leather sheath.	1	6

UTILITY KNIVES

CAT. NO.	MFG. NO.	DESCRIPTION	BOX QTY.	VOL. QTY.
----------	----------	-------------	----------	-----------



UTILITY KNIVES

R435000	82	Red w/push button slide and 3 blades.	12	24
---------	----	---------------------------------------	----	----

QUICK CHANGE UTILITY KNIFE - ERGONOMICS - WITH HOLSTER

R435010	357Y	Yellow w/push button slide and 3 blades.	12	24
---------	------	--	----	----

R435020	357B	Blue w/push button slide and 3 blades.	12	24
---------	------	--	----	----



R435100		Utility Jack knife (wood handle)	1	12
---------	--	----------------------------------	---	----

R435150		Utility Jack knife (ergo handle)	1	12
---------	--	----------------------------------	---	----



R435500		Pushbutton Slide Lock. Comes with 2 steel blades. Handle storage.	1	10
---------	--	---	---	----

R435600		All metal fixed blade. Handle storage comes with 2 blades.	1	10
---------	--	--	---	----



R435700		Heavy Duty blades for Utility Knives 5 pack.	1pk.	-
---------	--	--	------	---



R435800		Heavy Duty blades for Utility Knives 100 pack.	1pk.	-
---------	--	--	------	---

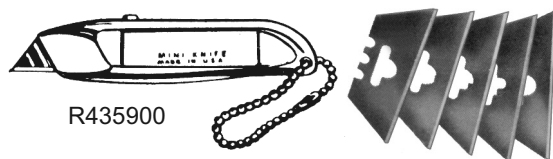

R435900		Mini-Knife Retractable blade, comes with 2 blades and key chain.	1	10
---------	--	--	---	----

R436000		Replacement blades for Mini-Knife, 5 blades per package.	1pk.	10pk.
---------	--	--	------	-------

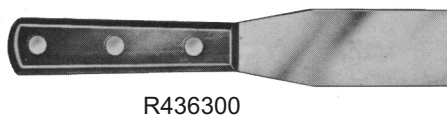



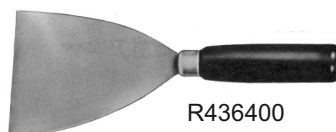

PUTTY KNIFE - SCRAPER

R436300	33-3302	1 1/4" blade width, flexible blade	1	5
---------	---------	------------------------------------	---	---

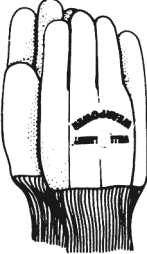
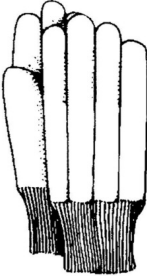
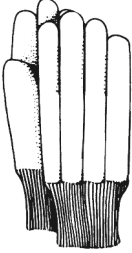
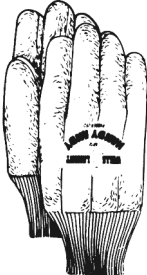

R436400	33-3304	3" blade width, flexible blade	1	5
---------	---------	--------------------------------	---	---

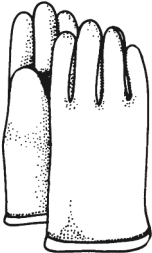
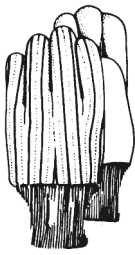
RICHARD SPECIALTY CO., INC.

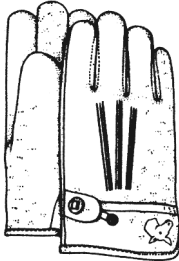
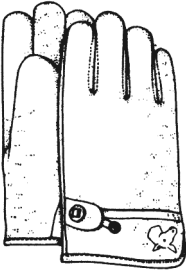
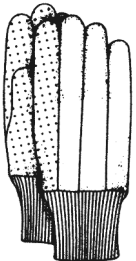
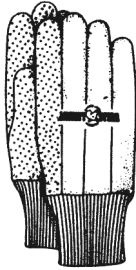
GLOVES		CAT. NO.	MFG. NO.	DESCRIPTION	BOX QTY.	VOL. QTY.
INDUSTRIAL WORK GLOVES						
		R438000	T-89	"Best Buy" cotton flannel glove	1dz.	3dz.
		R438050	CH-92	90/10 cotton/jersey gloves	1dz.	3dz.
		R438100	T-92	"Best Buy" Jersey glove	1dz.	3dz.
		R438200	2207	"Handy Andy" Chore gloves, rubberized. Knit wrist	1dz.	3dz.
		R438400	566-KW	"Handy Andy" Chore gloves, cotton flanel, rayon lining, knit wrist, clute cut	1dz.	3dz.
		R438600	CH-113T	"Ritzee" Jersey gloves gunn cut with red fleece lining	1dz.	3dz.
		R438800	TB-645-E	Pearl suede cowhide leather palm continuous thumb, knit wrist, clute cut	1dz.	2dz.
		R439000	TB-23-E	"White Mule" Leather palm gloves. Continuous thumb, safety cuff, gunn cut	1dz.	2dz.
		R439000	B-540-L	"Trucker's Special" Full Cowhide leather with tape fastener	1dz.	2dz.
		R439010	T-340-L	Suede cowhide leather continuous thumb, ball and tape wrist closure, gunn cut	1dz.	2dz.
		R439020	T-92-P	9 oz. 70/30 cotton polyester, plastic dots on palm and forefinger, knit wrist, clute cut	1dz.	2dz.
		R439030	T-30-P	10 oz. white cotton with hob nob dots on palm, thumb and forefinger, knit wrist clute cut	1dz.	2dz.

RODS & HACKSAW BLADES

CAT. NO.	MFG. NO.	DESCRIPTION	BOX QTY.	VOL. QTY.
THE EXCLUSIVE REMINGTON "GRIT-EDGE" TUNGSTEN CARBIDE ROD SAW BLADES				
R439200	GG10	10" Rod Saw Blade	1	10
R439300	GG12	12" Rod Saw Blade	1	10



MISCELLANEOUS PRODUCTS

CAT. NO.	MFG. NO.	DESCRIPTION	BOX QTY.	VOL. QTY.
PLUMBERS POINTING TROWEL				
R440000	284	5 1/2" Pointing trowel-steel.	1	12
R440010	270	7 1/2" Pointing trowel-steel.	1	12
R440015	286	10" Pointing trowel-steel.	1	12
R440020	287	10" x 4 1/2" Cement trowel-steel.	1	12

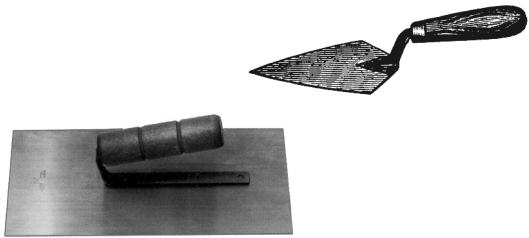

ICE MAKER KIT

R440200		Comes complete with 24 feet of plastic tubing.	1	6
R440210		Comes complete with 24 feet of copper tubing.	1	6

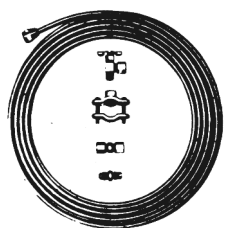

TIE WIRE AND REELS

R440300		Tie Wire refills 3 1/2 pound coils 18 Ga. Galvanized wire.	(1)20	40
R440400		Tie Wire refills 3 1/2 pound coils 16 Ga. Black Annealed wire.	(1)20	40
R440500		PVC Bonded Tie Wire 3 pound coils Ideal for hanging PVC plastic pipe.	(1)20	40
R440600		Mechanics Wire 18 Ga. Galvanized on 5 pound spool.	5	10
R440610		Mechanics Wire 18 Ga. Galvanized on 2 pound spool.	30	60
R440700		Stove Pipe Wire 18 Ga. Galvanized 50' coils.	24	48
R440800		Reels for tie wire. Handy reel can be worn on belt out of the way - always with you when wire is needed. Easy loading. (Reel comes without wire.)	1	6



RICHARD SPECIALTY CO., INC.

MISCELLANEOUS PRODUCTS

CAT. NO.	MFG. NO.	DESCRIPTION	BOX QTY.	VOL. QTY.
----------	----------	-------------	----------	-----------

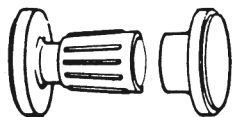

SHOWER CURTAIN ROD HOLDER Adjustable

R440900		Fits any 15/16" or 1" rod, made of durable lucit.	1	12
---------	--	---	---	----



SHOWER RODS - 1" O.D.

ALUMINUM

R440910		5 Ft.	1	50
R440912		6 Ft.	1	50
R440914		7 Ft.	1	50



ALUMINUM WITH FLANGE

R440920		5 Ft.	1	50
R440922		6 Ft.	1	50
R440924		7 Ft.	1	50



ALUMINUM ADJUSTABLE SHOWER ROD

R440928		6 Ft.	1	50
---------	--	-------	---	----

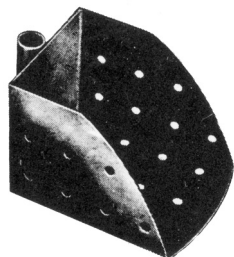

CORNER SHOWER RODS Aluminum with Flange

R440950		5 Ft.	1	4
---------	--	-------	---	---

SEWER OR BASIN SCOOP

R441000		Extra heavy back plate. Size 6" x 7" x 9".	1	6
---------	--	--	---	---



KEY CADDY

R441100	SK-1	Returns keys automatically. Heavy duty chrome plated, has belt clip.	1	6
---------	------	--	---	---

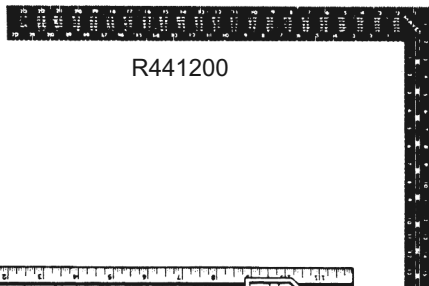

R441200

CARPENTER'S SQUARE

R441200	CS650	Black with white markings. Face graduated 8ths. and 16ths. Back 10ths., 12ths. and 16ths. 16" x 24".	1	6
---------	-------	--	---	---

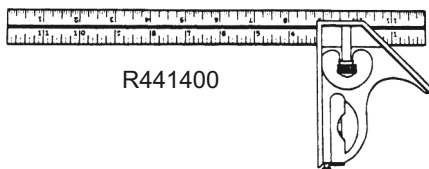

R441400

COMBINATION SQUARE

R441400	MCS12	12" long 1" wide and grooved. Moving handle with brass locking screw. Vial in handle for leveling and plumbing. Scriber in handle. Graduated in 8ths and 16ths one side 16ths and 32nds other side	1	6
---------	-------	--	---	---

MISCELLANEOUS PRODUCTS

	CAT. NO.	MFG. NO.	DESCRIPTION	BOX QTY.	VOL. QTY.
PLUNGERS					
	R441800				
	R441700				
	R441810				
	R441700	1470	Master Plunger, heavy duty. Has fold in bottom for flat surfaces too. Positive seal prevents backsplash. 6" gray cup with long handle.	1	6
	R441800	1522	Dual Plunger, household size. 5 1/2" red cup with long handle.	1	6
	R441810	1474	Bowl Plunger - Extra Large	1	6
SUCTION DEVICES					
	R441825				
	R441828				
	R441830				
	R441835				
	R441837				
	R441840				
	R441845				
	R441825		Last Drop Suction Gun	1	6 12
	R441828		The Plumber Trunk	1	6 12
	R441830		Condensate Drain Cleaner Gun	1	6 12
	R441835		End Piece for R441825	1	-
	R441837		Trap Straw, use with Last Drop Suction Gun to remove water from traps	1	-
	R441840		Condensate Cleaner End Piece to Put on End of Last Drop Suction Gun	1	-
	R441845		Condensate Drain Cleaner with Hose	1	6 12



Insert the hose tip into the toilet bowl and draw water into THE TRUNK by pulling handle out

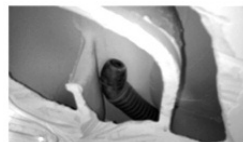

Advance the hose forward through the trap of the toilet until you are over the weir of the trap



Push the handle back in to release the water down the backside of the trap and down the drain

RICHARD SPECIALTY CO., INC.

LIFT & FLOAT RODS

CAT. NO.	MFG. NO.	SIZE	DESCRIPTION	BOX QTY.	VOL. QTY.
----------	----------	------	-------------	----------	-----------



BLUE MONSTER BOLTS

R442400	73065	5/16" x 2-1/4"	Solid Brass 2/Bag	1	100
R442405	73070	5/16" x 3-1/2"	Solid Brass 2/Bag	1	100

LOWER LIFT RODS

R443000		5"	Solid Brass	(1)100	200
---------	--	----	-------------	--------	-----



UPPER LIFT RODS

R443100		8 1/2"	Solid Brass	(1)100	200
---------	--	--------	-------------	--------	-----



FLOAT RODS

R443200		8"	Brass	1	25
R443300		9"	Brass	1	25
R443400		10"	Brass	1	25
R443500		12"	Brass	1	25



OVERFLOW TUBES

R443700		1" x 10"	Brass	1	12
---------	--	----------	-------	---	----



PLASTIC PIPE SAWS & CUTTERS

CAT. NO.	MFG. NO.	DESCRIPTION	BOX QTY.	VOL. QTY.
----------	----------	-------------	----------	-----------



ROPE SAW

R443790	RS32	Cuts plastic, wood, rubber & more	1	*
---------	------	-----------------------------------	---	---

PVC CABLE SAW

R443800	PS1000	Cable Saw 42" long	1	*
R443900	PS500	Cable Saw 25" long	1	*

*Check Price Sheet For Volume Quantity

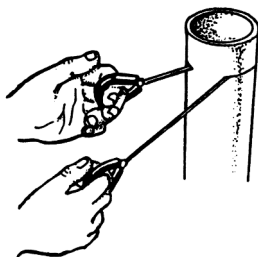

PVC/ABS HAND SAW





R444000		9" PVC/ABS Hand Saw	1	5
R444001		9" Replacement Blade	1	-
R444005		13" PVC/ABS Hand Saw	1	5
R444007		13" Replacement Blade	1	-
R444010		18" PVC/ABS Hand Saw	1	5
R444011		18" Replacement Blade	1	-



*Check Price Sheet For Volume Quantity.







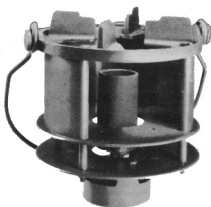
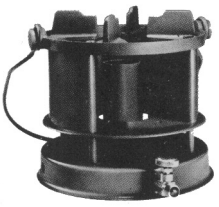
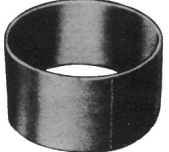

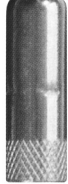



SAWS		CAT. NO.	MFG. NO.	DESCRIPTION	BOX QTY.	VOL. QTY.
	R444100			15" Jack Saw 9 PT.	2	6
	R444110			20" Jack Saw 9 PT.	2	6
	R444115			24" Jack Saw 9 PT.	2	6
	R444130			15" Jack Saw 12 PT.	2	6
	R444140			8" E-Z Stroke Saw	1	5
	R444145			8" Replacement Blade	1	5
	R444150			12" E-Z Stroke Saw	1	5
	R444155			12" Replacement Blade	1	5
	R444200	E-33		18" Handi Saw	1	6
	R444300	E-33-B		Handi Saw Blade	1	6
INSIDE PVC PIPE CUTTERS						
R444305		R444305	PS-100	4" with High Speed Metal Blade	1	6
R444310		R444310	PS-100	6" with High Speed Metal Blade	1	6
		R444315	PS-102	Blade Only	1	6
		R444320	LP2	3" Shaft with 2 Abrasive Blades	1	6
		R444325	RB3	3 Replacement Blades	3	6
		R444330		#100 Cutter with 1 Blade HS64 Cuts 3/4" - 2" #40 PVC Pipe	1	6
		R444331		#100 Cutter with 1 Blade Cuts 1/2" PVC Fire Sprinkler Fitting	1	6
		R444332		HS64 Blade (1-1/4" - 2" #40 Pipe)	1	6
		R444333		HS84 Blade (1" ID #40 Pipe)	1	6
		R444334		HS134 Blade (3/4" ID #40 Pipe)	1	6
		R444335		HS144 Blade (1/2" PVC Fire Sprinkler Reducer Fitting)	1	6
		R444336		#200 Cutter (2 Blades for 1-1/2" - 6" Pipe)	1	6
		R444337		#15532 Blade (1-1/2" - 2")	1	2
		R444338		#25540 Blade (3" - 6")	1	2

RICHARD SPECIALTY CO., INC.

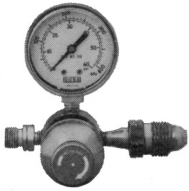
PIPE CUTTERS		CAT. NO.	DESCRIPTION	BOX QTY.	VOL. QTY.
PVC PIPE CUTTERS					
		R444340	1-5/8" Double Action Ratchet Cutter	1	3
		R444342	Replacement Blades for Above	1	-
R444350	R444340	R444350	1" Plastic cutter	1	3
		R444355	1" Replacement blade only	1	3
		R444357	2" Plastic Cutter (One Hand)	1	2
		R444358	2" Blade	1	2
R444357	R444360	R444360	2" Plastic Cutter (Two Hand)	1	2
		R444365	2" Blade	1	2

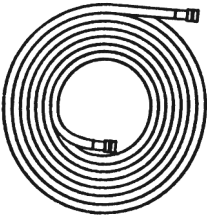
PROPANE (LP) CYLINDERS, FURNACES		CAT. NO.	DESCRIPTION	CAPACITY	BOX QTY.	VOL. QTY.
		R444500	Regular cylinder	20 LBS.	1	2
		R445000	Screw on furnace with shield		1	2
		R445100	Floor furnace		1	2
		R445400	Straight wind shield (fits all furnaces)		1	2
R445100	R445000	R445450	Torch Safe Utility Torch Holder Quickly mounts with 2 provided screws. Holds 14.1oz/400g torches • Eliminates torch tip-overs • Prevents torch damage • Ends broken torch heads		1	6
		R445500	GP-9 Fits all throw away and refillable cylinders. Has 3 burners in 1 - pencil point, medium pencil and large brush. For Mapp or Propage gas.		1	2
	R445450	R445550	GP-600 Self-igniting hand torch for disposable cylinders		1	2
		R445555	BP-22LTE Replacement tip for GP-600		1	2
R445500	R445550	R445600	Lead Melting Kit, consisting of: 1 - R445100 Floor Furnace, 1 - R445400 Straight Shield, 1 - R445773, IP-2 Cylinder to hose adaptor & 1 - R445755 HEF-10 10' hose (No cylinder)		1	2

PROPANE GAS EQUIPMENT		CAT. NO.	MFG. NO.	DESCRIPTION	BOX QTY.	VOL. QTY.
		R445700	AP-1	Handle	1	2
		R445705	BP-1	Tip up to 1/2" tubing	1	2
		R445710	BP-2	Tip up to 1 1/2" tubing	1	2
		R445725	BP-5	Tip up to 4" tubing	1	2
		R445730	BP-6	Tip up to 6" tubing	1	2
		R445735	BP-15PM	Tip soft solders up to 1 1/2", silver brazes up to 5/8"	1	2
		R445740	BP-17M	Tip soft solders up to 4", silver brazes up to 2 1/8"	1	2
	R445745	R445745	EP-70G	Regulator with gauge	1	2
	R445750	R445750	EP-80G	Regulator without gauge	1	2
	R445755 - R445770					
	R445773					
		R445755	HEF-10	10' Hose	1	2
		R445760	HEF-12	12' Hose	1	2
		R445765	HEF-20	20' Hose	1	2
		R445770	HEF-25	25' Hose	1	2
		R445773	IP-2	Cylinder to hose adaptor	1	2
		R445775	KP-102	Kit	1	2

RICHARD SPECIALTY CO., INC.

PROPANE GAS EQUIPMENT

CAT. NO.	MFG. NO.	DESCRIPTION	BOX QTY.	VOL. QTY.
----------	----------	-------------	----------	-----------

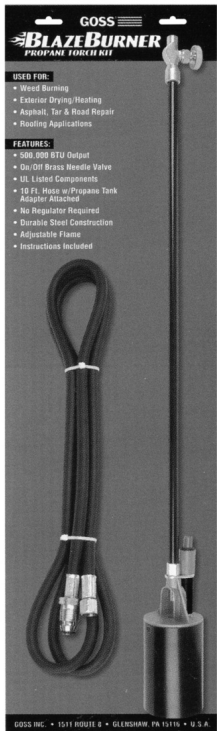

R445785

BLAZE BURNER TORCH KITS

R445780	KP-320A	AP-20 Torch. MP-1 Lighter, HPX-10, 10 ft. Hose with Cylinder Adaptor	1	2
---------	---------	--	---	---



R445790

R445785	KP-320MA	AP-20M Torch with Piezoelectric Igniter Tip, HPX-10, 10 ft. Hose with Cylinder Adaptor	1	2
---------	----------	--	---	---

TORCH GUN KIT

R445790	GX-10K	Torch with instant ignition trigger, flame adjustment, belt clip to hold cylinder*, 5ft. hose, built-in hose swivel	1	2
---------	--------	---	---	---

*Cylinder Not Included



ACETYLENE GAS EQUIPMENT

CAT. NO.	MFG. NO.	SOFT SOLDER (INCHES)	SILVER SOLDER (INCHES)	BOX QTY.	VOL. QTY.
----------	----------	----------------------	------------------------	----------	-----------



R445800	AA-1	Handle		1	2
---------	------	--------	--	---	---



R445802	BA-1	1/16 - 1/8	1/16 - 1/8	1	2
---------	------	------------	------------	---	---



R445804	BA-2	1/8 - 1/4	1/8 - 1/4	1	2
---------	------	-----------	-----------	---	---



R445806	BA-3	1/4 - 1/2	1/4 - 1/2	1	2
---------	------	-----------	-----------	---	---



R445808	BA-4	1/2 - 1	1/2 - 3/4	1	2
---------	------	---------	-----------	---	---



R445810	BA-5	1 - 1 1/2	3/4 - 1	1	2
---------	------	-----------	---------	---	---



R445812	BA-6	2 - 4	1 - 1 1/4	1	2
---------	------	-------	-----------	---	---







R445815	BA-10A	1 - 3	Up to 2	1	2
---------	--------	-------	---------	---	---

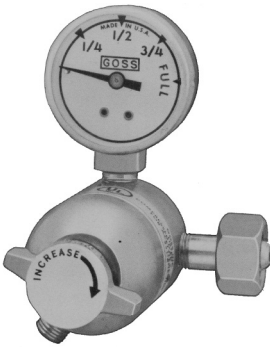

R445820	BA-12A	1 - 6	Up to 2 3/4	1	2
---------	--------	-------	-------------	---	---

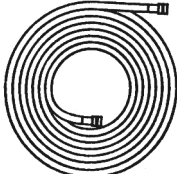
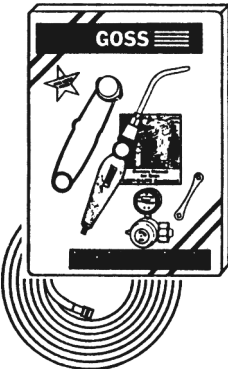
ACETYLENE GAS EQUIPMENT

	CAT. NO.	MFG. NO.	DESCRIPTION	BOX QTY.	VOL. QTY.
	R445822	EA-1G	Regulator w/gauge for B tank	1	2
	R445824	EA-2G	Regulator w/gauge for MC tank	1	2
	R445830	MA-80-16	Replacement Gauge	1	3
	R445835	HA3-12	12' Hose	1	2
	R445840	HA3-25	25' Hose	1	2
	R445845	KA-1H	Kit	1	2
	R445850	MP-4	Wrench	1	6
	R445855	MA-2	Wrench	1	6

TAPE



TEFLON™ THREAD SEAL manufactured from virgin teflon. Made in U.S.A. Thickness .0035" +/- .0005". Material meets MIL-T-27730A specification. Comes on plastic spools.

CAT. NO.	SIZE	BOX QTY.	VOL. QTY.	CAT. NO.	SIZE	BOX QTY.	VOL. QTY.
R446100	1/4" x 520"	(1)144	144	R447000	3/4" x 260"	(1)144	144
R446200	1/2" x 100"	(1)144	144	R447100	3/4" x 300"	(1)144	144
R446300	1/2" x 260"	(1)144	144	R447200	3/4" x 520"	(1)144	144
R446400	1/2" x 300"	(1)144	144	R447400	3/4" x 1296"	(1)144	144
R446500	1/2" x 520"	(1)144	144	R447500	1" x 260"	(1)144	144
R446600	1/2" x 600"	(1)144	144	R447600	1" x 520"	(1)144	144
R446700	1/2" x 1296"	(1)144	144	R447700	1" x 1296"	(1)144	144

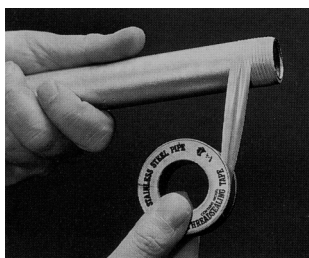

TEFLON™ THREAD SEAL - GAS - YELLOW - FULL DENSITY (TF520) A.G.A. 4-90 Thickness .004" +/- .0005".

PSI rating 10,000 PSI, temp. -450° F to +550° for gas line, natural gas, propane, butane and/or water, oil & chemicals.

CAT. NO.	MFG. NO.	DESCRIPTION	BOX QTY.	VOL. QTY.
R447710	70820	1/2" x 260" Roll	10	20
R447715	70830	3/4" x 260" Roll	6	12
R447720	70840	1" x 260" Roll	6	12

RICHARD SPECIALTY CO., INC.

TAPE	CAT. NO.	MFG. NO.	SIZE	BOX QTY.	VOL. QTY.
------	----------	----------	------	----------	-----------

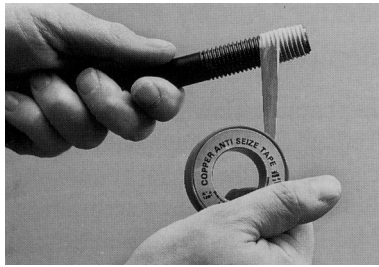

TEFLON™ THREAD SEAL - OXYGEN - GREEN (TF5-25)

Oxygen seal tape is a degreased version of gas seal tape. Thickness .004" +/- .0005". PSI rating 3,000 PSI, temperature -450° F to +550° F compatible with oxygen applications.

R447750	70850	1/2" x 260"	Roll	10	20
R447755	70852	3/4" x 260"	Roll	6	12
R447760	70854	1" x 260"	Roll	6	12

TEFLON™ THREAD SEAL - STEAM, WATER - RED

R447765	70796	1/2" x 260"	Roll	10	20
R447770	70797	1/2" x 540"	Roll	10	20
R447775	70798	3/4" x 260"	Roll	6	12
R447780	70801	3/4" x 540"	Roll	6	12



BLUE MONSTER® TEFLON™ TAPE

R447785	70885	1/2" x 1429"	Roll	45	90
R447790	70886	3/4" x 1429"	Roll	27	54
R447795	70887	1" x 1429"	Roll	27	54



TEFLON™ PACKING SEAL TAPE

R447800		3/32" x 20 FT.		1	6*
R447900		3/32" x 50 FT.		1	6*
R447905		5/32" x 15 FT.		1	6*
R447910		5/32" x 35 FT.		1	6*
R447915		7/32" x 15 FT.		1	6*
R447920		9/32" x 9 FT.		1	6*

* May Be Assorted For Volume Quantity.

CARTON SEALING TAPE

R448600	119	2" x 55 yd.	Carton Sealing tape. Polypropylene-tan	36	144
R448700	119	2" x 55 yd.	Carton Sealing tape. Polypropylene-clear	36	144



FILAMENT TAPE

R448800	868	3/4" x 60 yd.	Filament tape. 140 lbs. tensile	48	144
---------	-----	---------------	---------------------------------	----	-----

ELECTRICAL TAPE

R449000	331	3/4" x 60 FT.	Standard electrical grade vinyl insulating tape. U.L. listed. 7 Mil.	10	100
R449100	333	3/4" x 66 FT.	All weather electrical vinyl insulating tape. U.L. listed. 7 Mil.	10	100



BLUE MONSTER® COMPRESSION SEAL TAPE

R449200	76085	12 FT. x 1"	Roll	10	30
R449205	76086	12 FT. x 2"	Roll	6	18



SCREWDRIVERS/STARTERS

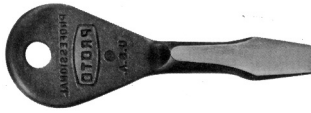

KEY RING SCREWDRIVER Standard tip
Fits standard key rings. Heat treated precision ground tip.

CAT. NO.	MFG. NO.	BIT WIDTH	LENGTH	BOX QTY.	VOL. QTY.
R451600	100	3/16"	2 1/4"	1	50

CAT. NO.	MFG. NO.	ROUND SIZE	BIT WIDTH	LENGTH	BOX QTY.	VOL. QTY.
----------	----------	------------	-----------	--------	----------	-----------

OFFSET SCREWDRIVERS Standard tip
Precision ground tips offset at right angles to each other.
Rust resistant finish.



R451800	36 1/4	1/4"	1/4"	4 5/8"	(1)6	6
R451900	36 5/16	5/16"	5/16"	5"	(1)6	6
R452000	36 3/8	3/8"	3/8"	6"	(1)6	6

CAT. NO.	MFG. NO.	PHILLIPS TIP NO.	OVERALL LENGTH	BOX QTY.	VOL. QTY.
----------	----------	------------------	----------------	----------	-----------

OFFSET SCREWDRIVERS Phillips tip



R452200	34 1/4	1 & 2	4 3/4"	(1)6	6
R452400	34 3/8	3 & 4	6"	(1)6	6

CAT. NO.	MFG. NO.	LENGTH	TYPE OF SCREW	BOX QTY.	VOL. QTY.
----------	----------	--------	---------------	----------	-----------

SCREW STARTERS Standard tip
Screw holding mechanism, powerful magnetic retrieving head.



R452500	D-1	2 1/2"	Standard	1	10
R452600	D-2	5 1/2"	Standard	1	10
R452700	D-3	9 1/2"	Standard	1	10
R452705	D-4	15"	Standard	1	6

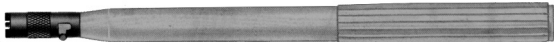

R452710	N-1	Nylon	2 5/8"	Standard	1	5
R452715	N-2	Nylon	6"	Standard	1	5
R452720	N-3	Nylon	9"	Standard	1	5
R452725	N-4	Nylon	15 1/4"	Standard	1	5

SCREW STARTERS Phillips tip



R452800	PD-9	2 5/8"	Phillips	1	10
R452900	PD-10	5 5/8"	Phillips	1	10
R453000	PD-11	9 5/8"	Phillips	1	10
R453100	PD-12	15 1/4"	Phillips	1	6



R453105	PN-9	Nylon	2 3/4"	Phillips	1	5
R453110	PN-10	Nylon	6 1/4"	Phillips	1	5
R453115	PN-11	Nylon	9 1/4"	Phillips	1	5
R453120	PN-12	Nylon	15 1/4"	Phillips	1	5

SCREW STARTERS Double ended











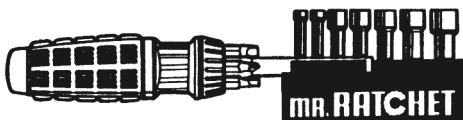

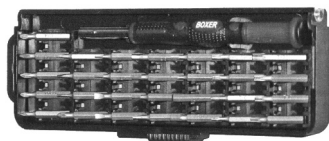

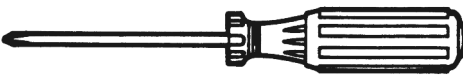
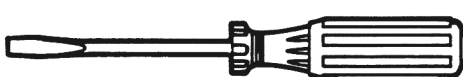

R453125	DE-1	Nylon	9"	Phillips & Slotted	1	12
---------	------	-------	----	--------------------	---	----

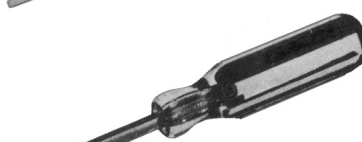
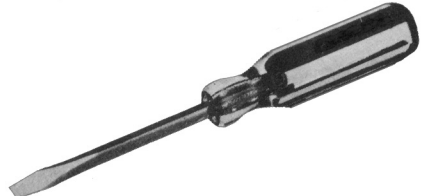

R453130	DE-2	Nylon	6 1/4"	Phillips & Slotted	1	12
---------	------	-------	--------	--------------------	---	----

RICHARD SPECIALTY CO., INC.

SCREWDRIVERS		CAT. NO.	MFG. NO.	DESCRIPTION	BOX QTY.	VOL. QTY.
		R453210	MR-1615	RATCHETING ACTION 6 Tips - 7 nut driver sockets	1	6
		R453220		MEGAPRO® 15 IN 1 Standard Contains Philips 0+3, 1+2; Square 0+3, 1+2; Torx® 10+15, 23+25; Slot 4+6	1	6
		R453225		MEGAPRO® 15 IN 1 Tamper Proof Contains Hex Pin 1/8+9/64, 5/32+3/16; Spanner 6+8, 10+12; Torx® Pin 10+15, 20+25, 27+30	1	6
		R453230		MEGAPRO® 15 IN 1 Stainless Steel Contains Philips 0+3, 1+2; Square 0+3, 1+2; Torx® 10+15, 20+25; Flat 4+6	1	6
		R453235		MEGAPRO® 15 IN 1 MEGALOCK Contains Philips 0+3, 1+2; Square 0+3, 1+2; Torx® 10+15, 20+25; Flat 4+6	1	6
		R453300		T-TORQUE DRIVER - RATCHET CMB6TRV T-Driver	(1)6	6
		R453320		PRECISION SCREWDRIVER KIT - 30 Pieces Precision Kit	1	4

CAT. NO.	MFG. NO.	DESCRIPTION	BLADE SIZE & LENGTH	BOX QTY.	VOL. QTY.	
CUSHION GRIP SCREWDRIVERS Chrome Vanadium						
		R455200	91104	Round Blade	3/16" x 6"	1 6
		R455300	91106	Round Blade	1/4" x 4"	1 6
		R455500	91110	Round Blade	5/16" x 6"	1 6
		R455700	91114	Phillips #2	1/4" x 1 1/4"	1 6
		R456200	91124	Square Blade	1/4" x 4"	1 6
		R456400	91128	Square Blade	3/8" x 8"	1 6
PLASTIC HANDLE SCREWDRIVER Chrome Vanadium						
Standard tip with round shank						
		R461400	B97200		1/8" x 4" with clip	1 6
		R461700	B97203		1/4" x 4"	1 6
		R461800	B97204		1/4" x 6"	1 6
		R462000	B97205		5/16" x 6"	1 6
		R462200	B97217		3/8" x 8"	1 6
PLASTIC HANDLE SCREWDRIVER Cabinet style						
with round shank						
		R462800	B97201		3/16" x 3"	1 6
		R463000	B97202		3/16" x 6"	1 6
PLASTIC HANDLE SCREWDRIVER Square shank						
Keystone tip						
		R463300	B97206		1/4" x 1 1/4"	1 6
		R463500	B97211		1/4" x 4"	1 6
		R463600	B97212		5/16" x 6"	1 6

SCREWDRIVERS

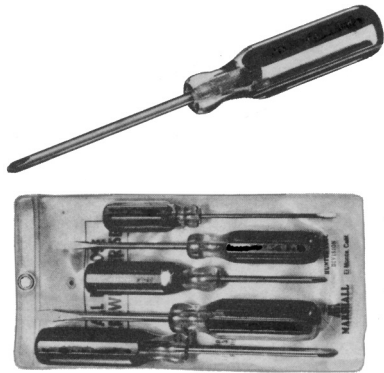

PLASTIC HANDLE SCREWDRIVERS Phillips tip, Chrome Vanadium

CAT. NO.	MFG. NO.	BLADE D & L	BOX QTY.	VOL. QTY.
R463900	B97213	#0 Phillips with clip	1	6
R464100	B97210	#2 Phillips - stubby	1	6
R464300	B97207	#1 x 3" Phillips	1	6
R464500	B97208	#2 x 4" Phillips	1	6
R464600	B97209	#3 x 6" Phillips	1	6
R465100	B97214	Kit with B97200, B97206, B97204, B97202, B97212, B97207 & B97208	1	2
R465110	B97215	Kit with B97204, B97202, B97203, B97207 & B97208	1	2

NUTDRIVERS

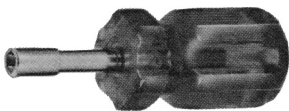

REGULAR NUTDRIVERS

CAT. NO.	HEX SIZE	BLADE LENGTH	HANDLE LENGTH	BOX QTY.	VOL. QTY.
R466100	3/16"	3"	3 3/4"	(1)6	6
R466200	7/32"	3"	3 3/4"	(1)6	6
R466300	1/4"	3"	3 3/4"	(1)6	6
R466400	9/32"	3"	3 3/4"	(1)6	6
R466500	5/16"	3"	3 3/4"	(1)6	6
R466600	11/32"	3"	3 3/4"	(1)6	6
R466700	3/8"	3"	3 3/4"	(1)6	6
R466800	7/16"	3 1/4"	3 3/4"	(1)6	6
R466900	1/2"	3 1/4"	4"	(1)6	6
R467000	9/16"	3 1/4"	4 1/2"	(1)6	6

NUTDRIVERS - Extra Long

R467105	3/16"	6"	3 1/2"	1	5
R467110	1/4"	6"	3 1/2"	1	5
R467115	5/16"	6"	3 1/2"	1	5
R467120	11/32"	6"	3 1/2"	1	5
R467125	3/8"	6"	3 1/2"	1	5
R467130	7/16"	6"	3 5/8"	1	5
R467135	1/2"	6"	3 5/8"	1	5

STUBBY NUTDRIVERS

R467200	1/4"	1 1/4"	1 7/8"	1	6
R467300	5/16"	1 1/4"	1 7/8"	1	6
R467400	3/8"	1 1/4"	1 7/8"	1	6

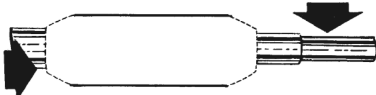
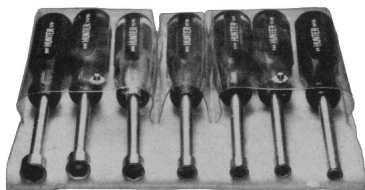

CAT. NO.	MFG. NO.	DESCRIPTION	BOX QTY.	VOL. QTY.
----------	----------	-------------	----------	-----------

R467500	ND7	Nutdriver Kit with 7 most popular sizes.	1	3
---------	-----	--	---	---

R467600	NLK7	Extra Long Nutdriver Kit with 7 most popular sizes.	1	3
---------	------	---	---	---

4 in 1 POCKET SOCKET

R467700	401	Four sizes in one tool. Sizes telescope within each other. Sizes 1/4", 5/16", 3/8", 7/16".	1	12
---------	-----	--	---	----

R467800	402	Same quality tool as 401 except different sizes. Sizes are 3/16", 7/32", 9/32", 11/32".	1	12
---------	-----	---	---	----

RICHARD SPECIALTY CO., INC.

RICHARD 4 IN 1 SCREWDRIVERS

CAT.
NO.

DESCRIPTION

BOX VOL.
QTY. QTY.

4 BITS IN ONE COMPACT TOOL

Quality tool steel bits heat treated for maximum strength. Six spline red tenite handle. Change bits in seconds, just pull out reverse and snap back.



R467810 4 in 1 reversible ratcheting screwdriver (also 1/4" nutdriver). (1)20 20



R468010 6 in 1 screwdriver 1/4" x 5/16" Nutdriver (1)12 24



R468100 Stubby 2 slotted bits (1)12 24



R468200 Stubby 2 phillips bits (1)12 24



R468300 Stubby combination 1 slotted & 1 phillips (1)12 24



R468400 Regular combination 1 slotted & 1 phillips (1)12 24



R468510 Phillips bit only 1/4" 1 6

R468600



R468600 Slotted bit only 1 6

R468700



R468700 Combo bit only 1 6

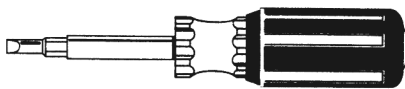

R468800 6 in 1 screwdriver with rubber cushion grip handles. (1)12 24

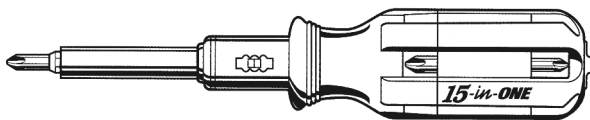
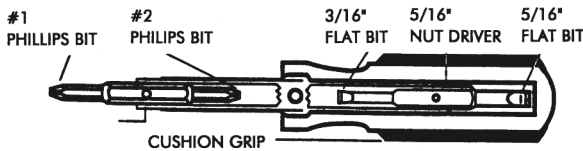

R468850 15 in 1 reversible ratcheting screwdriver & 1/4" nutdriver. 1 12

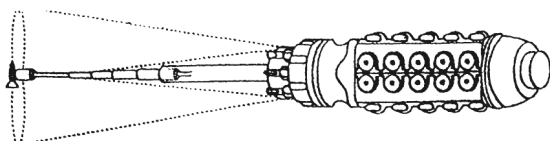

R468940 MLS-1 Micro Lite with magnet. (1)12 24

HEX PRODUCTS		CAT. NO.	MFG. NO.	HANDLE LENGTH	BLADE LENGTH	BLADE SIZES	BOX QTY.	VOL. QTY.
---------------------	--	----------	----------	---------------	--------------	-------------	----------	-----------

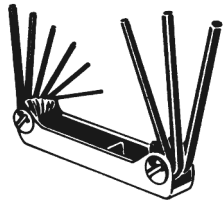

SMITTY FOLDING HEX KEY SETS

Heat treated & chrome plated.

R469000	10181-C	3"	2"	.050", 1/16", 5/64", 3/32", 7/64", 1/8", 9/64", 5/32"	1	6
---------	---------	----	----	---	---	---

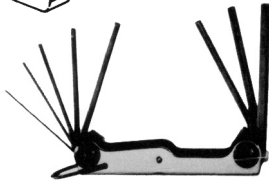

R469200	10191-C	4 1/2"	3"	5/64", 3/32", 7/64", 1/8", 9/64", 5/32", 3/16", 7/32", 1/4"	1	6
---------	---------	--------	----	---	---	---

R469300	10192-C	3 1/2"	2 1/2"	.050", 1/16", 5/64", 3/32", 7/64", 1/8", 9/64", 5/32", 3/16"	1	6
---------	---------	--------	--------	--	---	---

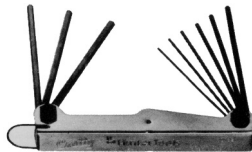

R469400	10151-C	5 1/4"	4"	3/16", 7/32", 1/4", 5/16", 3/8"	1	6
---------	---------	--------	----	---------------------------------	---	---

R469500	10182-C	6"	5"	5/64", 3/32", 7/64", 1/8", 9/64", 5/32", 3/16", 7/32", 1/4"	1	6
---------	---------	----	----	---	---	---

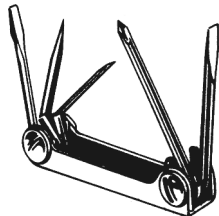

R469600	10198-C Metric	3 1/4"	2"	1.5mm, 2mm, 2.5mm, 3mm, 4mm, 5mm, 6mm	1	6
---------	-------------------	--------	----	---------------------------------------	---	---

R469700	45	5 in 1 Screwdriver set includes No. 1 phillips, 1/4" flat, 3/16" flat, 1/8" flat and 3/16" point awl.			1	6
---------	----	---	--	--	---	---



ERGO - SMITTY FOLDING HEX KEY SETS

R469710	25912		3"	.050", 1/16", 5/64", 3/32", 7/64", 1/8", 9/64", 5/32", 3/16"	1	6
---------	-------	--	----	--	---	---

R469720	25911		4"	5/64", 3/32", 7/64", 1/8", 9/64", 5/32", 3/16", 7/32", 1/4"	1	6
---------	-------	--	----	---	---	---

R469730	25611		5"	5/32", 3/16", 7/32", 1/4", 5/16", 3/8"	1	6
---------	-------	--	----	--	---	---

HEX PRODUCTS		CAT. NO.	HEX SIZE	BLADE LENGTH	CAT. NO.	HEX SIZE	BLADE LENGTH	BOX QTY.	VOL. QTY.
---------------------	--	----------	----------	--------------	----------	----------	--------------	----------	-----------



T-WRENCHES with soft over-mold for comfort and slip resistance.

R470000	3/32"	6"	R471000	3/32"	9"	1	6
R470100	7/64"	6"	R471100	7/64"	9"	1	6
R470200	1/8"	6"	R471200	1/8"	9"	1	6
R470300	9/64"	6"	R471300	9/64"	9"	1	6
R470400	5/32"	6"	R471400	5/32"	9"	1	6
R470500	3/16"	6"	R471500	3/16"	9"	1	6
R470600	7/32"	6"	R471600	7/32"	9"	1	6
R470700	1/4"	6"	R471700	1/4"	9"	1	6
R470800	5/16"	6"	R471800	5/16"	9"	1	6
R470900	3/8"	6"	R471900	3/8"	9"	1	6

RICHARD SPECIALTY CO., INC.

T-WRENCHES

CAT. NO.	MFG. NO.	BLADE SIZE	DESCRIPTION	BOX QTY.	VOL. QTY.
----------	----------	------------	-------------	----------	-----------



T-WRENCHES STANDS AND KITS

R472000	60614	6"	11 pc. Master set with metal stand. Includes 5/64", 3/32", 7/64", 1/8", 9/64", 5/32", 3/16", 7/32", 1/4", 5/16", 3/8".	1	2
---------	-------	----	--	---	---

R472100	60914	9"	11 pc. Master set with metal stand. Includes same sizes as 6" set above.	1	2
---------	-------	----	--	---	---



R472200	60609	6"	"Tradesman" 9 pc. set with sizes 5/64", 3/32", 7/64", 1/8", 9/64", 5/32", 3/16", 7/32", 1/4" and heavy vinyl kit.	1	2
---------	-------	----	---	---	---

R472300	60909	9"	"Tradesman" 9 pc. set same as 6" set above.	1	2
---------	-------	----	---	---	---

R472400	60911	9"	Deluxe Roll Up Kit. 11 pcs. 3/32", 7/64", 1/8", 9/64", 5/32", 3/16", 7/32", 1/4". Heavy duty roll up kit.	1	2
---------	-------	----	---	---	---

R472500	64606	6"	Metric Deluxe Roll Up Kit. 6 pcs. 2mm, 2.5mm, 3mm, 4mm, 5mm, 6mm.	1	2
---------	-------	----	---	---	---

"L" KEY SETS

CAT. NO.	MFG. NO.	DESCRIPTION	BOX QTY.	VOL. QTY.
----------	----------	-------------	----------	-----------

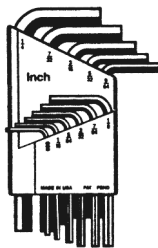

R472600	10111	Short Arm Set 11 pc. Sizes .050", 1/16", 5/64", 3/32", 7/64", 1/8", 9/64", 5/32", 3/16", 7/32", 1/4".	1	6
---------	-------	---	---	---

R472600

R472700	10113	Short Arm Set 13 pc. Sizes .050", 1/16", 5/64", 3/32", 7/64", 1/8", 9/64", 5/32", 3/16", 7/32", 1/4", 5/16", 3/8".	1	6
---------	-------	--	---	---



R472800

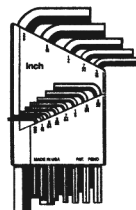

R472700

R472800	10018	Long and Short Arm - Combo Kit. 9 short arm - .050", 1/16", 5/64", 3/32", 7/64", 1/8", 5/32", 3/16", 7/32". 9 long arm - 1/16", 5/64", 3/32", 1/8", 9/64", 5/32", 3/16", 1/4", 5/16".	1	6
---------	-------	---	---	---

"L" KEY SETS



R472950

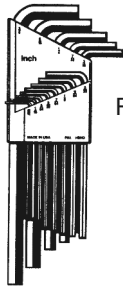

R472900



R473000



R473010

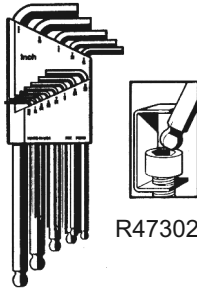

R473020

"L" KEY SETS

CAT. NO.	MFG. NO.	DESCRIPTION	BOX QTY.	VOL. QTY.
R472900	10213	Long Arm Hexdrivers. 6" long O.A. 13 pc. kit. Sizes .050", 1/16", 5/64", 3/32", 7/64", 1/8", 9/64", 5/32", 3/16", 7/32", 1/4", 5/16", 3/8".	1	6

R472950	10407	Extra Long Arm Hexdrivers 12" long. Sizes 5/64" to 1/4".	1	6
---------	-------	--	---	---

R473000	10118	Deluxe Metal Box-Kit 18 pc. set packed in metal box. Short arm type keys range in size from .028" through 5/8".	1	3
---------	-------	---	---	---

BALL-HEX-L™ KEY SETS

R473010	13207	5/64" to 1/4" in plastic holder	1	6
---------	-------	---------------------------------	---	---

R473020	13213	.050" to 3/8" in plastic holder	1	6
---------	-------	---------------------------------	---	---

GAUGE GLASS

MAXIMUM RECOMMENDED WORKING PRESSURE, PSI

A*				B*				A*				B*			
CAT. NO.	SIZE	TEMP.	PSI	CAT. NO.	SIZE	TEMP.	PSI	CAT. NO.	SIZE	TEMP.	PSI	CAT. NO.	SIZE	TEMP.	PSI
LOW PRESSURE				HIGH PRESSURE				RED LINE				BOX QTY.	VOL. QTY.		
R473500	5/8" x 8"	210	100	R474800	5/8" x 8"	435	320	R475900	5/8" x 8"	370	285	6	12		
R473600	5/8" x 10"	210	100	R474900	5/8" x 10"	420	315	R475905	5/8" x 10"	345	280	6	12		
R473700	5/8" x 12"	205	100	R475000	5/8" x 12"	410	305	R475910	5/8" x 12"	335	280	6	12		
R473800	5/8" x 14"	200	100	R475100	5/8" x 14"	390	295	R475915	5/8" x 14"	325	275	6	12		
R473900	5/8" x 16"	195	100	R475200	5/8" x 16"	375	285	R475920	5/8" x 16"	315	270	6	12		
R474000	5/8" x 18"	190	100	R475300	5/8" x 18"	360	280	R475925	5/8" x 18"	305	265	6	12		
R474100	5/8" x 20"	185	100	R475400	5/8" x 20"	350	270	R475930	5/8" x 20"	290	265	6	12		
R474200	5/8" x 24"	180	100	R475500	5/8" x 24"	320	255	R475935	5/8" x 24"	265	255	6	12		
R474300	5/8" x 30"	175	NR*	R475600	5/8" x 30"	280	NR*	R475940	5/8" x 30"	235	NR*	6	12		
R474400	5/8" x 36"	165	NR*	R475700	5/8" x 36"	245	NR*	R475945	5/8" x 36"	205	NR*	6	12		
R474500	5/8" x 48"	140	NR*	R475800	5/8" x 48"	195	NR*	R475950	5/8" x 48"	165	NR*	6	12		
R474505	3/4" x 8"	210	100	R475805	3/4" x 8"	425	315	R476005	3/4" x 8"	360	280	6	12		
R474510	3/4" x 10"	210	100	R475810	3/4" x 10"	410	310	R476010	3/4" x 10"	340	275	6	12		
R474515	3/4" x 12"	205	100	R475815	3/4" x 12"	400	300	R476015	3/4" x 12"	330	275	6	12		
R474520	3/4" x 14"	200	100	R475820	3/4" x 14"	385	290	R476020	3/4" x 14"	320	270	6	12		
R474525	3/4" x 16"	195	100	R475825	3/4" x 16"	370	280	R476025	3/4" x 16"	310	265	6	12		
R474530	3/4" x 18"	190	100	R475830	3/4" x 18"	355	275	R476030	3/4" x 18"	300	260	6	12		
R474535	3/4" x 20"	185	100	R475835	3/4" x 20"	345	265	R476035	3/4" x 20"	285	260	6	12		
R474540	3/4" x 24"	180	NR*	R475840	3/4" x 24"	315	250	R476040	3/4" x 24"	260	250	6	12		
R474545	3/4" x 30"	175	NR*	R475845	3/4" x 30"	275	NR*	R476045	3/4" x 30"	230	NR*	6	12		
R474550	3/4" x 36"	165	NR*	R475850	3/4" x 36"	240	NR*	R476050	3/4" x 36"	200	NR*	6	12		
R474555	3/4" x 48"	140	NR*	R475855	3/4" x 48"	190	NR*	R476055	3/4" x 48"	160	NR*	6	12		

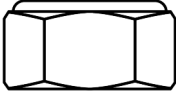
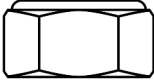







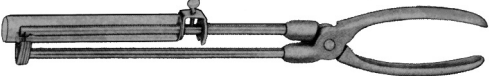

CHART HEADING A* = Temperature Up to 150°F No Corrosion

CHART HEADING B* = Steam Boiler Service Up to 425°F

*NR = NOT RECOMMENDED

RICHARD SPECIALTY CO., INC.

GAUGE GLASS WASHERS		CAT. NO.	SIZE	DESCRIPTION	BOX QTY.	VOL. QTY.
GAUGE GLASS WASHERS - RUBBER						
		R476100	5/8"	9/16" x 13/16" x 1/4"	1	36
	R476100- R476110	R476110	3/4"	3/4" x 15/16" x 3/8"	1	36
		R476115	15/16-20 Thread Gauge Glass Nut, Pkg of 2		1PK	12PK
R476115- R476120		R476120	15/16-18 Thread Gauge Glass Nut General Replacement, Pkg of 2		1PK	12PK
		R476125	Repair Kit with (2) ea. R470115 Nuts, Friction Washer, Standard Gauge Glass Washer		1	5
		R476130	Repair Kit General Replacement, (2) ea. Nuts, Friction Washer, Standard Gauge Glass Washer		1	5
R476135		R476135	Gauge Glass Nut Friction Washer, Universal Replacement, Pkg of 6		1PK	2PK
	R476125- R476130					

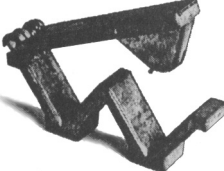
GAUGE GLASS CUTTERS		CAT. NO.	MFG. NO.	DESCRIPTION	BOX QTY.	VOL. QTY.
		R476600	69012	"Squeeze & Pop" Cutter for material through 3/4"	1	3
R476600		R476700	690012	Replacement Chain for 69012	1	-
		R476800	79014	"Squeeze & Pop" Cutter for material through 1"	1	3
R476800		R476900	7914	Replacement Chain for 79014	1	-
		R476950	79022	"Squeeze & Pop" Cutter for material through 1 1/2"	1	3
		R476960	7922	Replacement Chain for 79022	1	-
R477000		R477000		Gauge glass cutter	1	6
		R477100		Gauge glass cutter extra wheels with pin	3	12
	R477110	R477110		Quarter Turn Gauge Glass Cutter	1	3

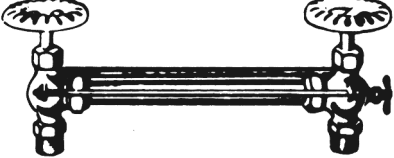
GAUGE GLASS CUTTERS		CAT. NO.	DESCRIPTION	BOX QTY.	VOL. QTY.
GAUGE GLASS SETS					
		R477400	3/8" I.P.S. Set	1	6
		R477500	1/2" I.P.S. Set	1	6
		R477550	1/2" I.P.S. Set - Import	1	6
		R477600	3/4" I.P.S. Set	1	6

SEWER TAPES

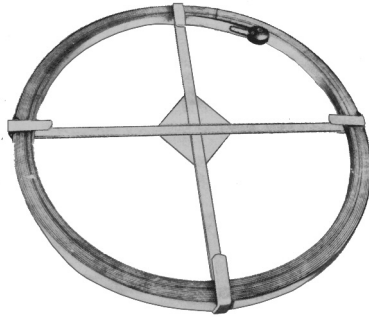

FLAT SEWER TAPES WITH ROLLER HEAD

CAT. NO.	DIA.	SIZE THICK	LENGTH	CAT. NO.	DIA.	SIZE THICK	LENGTH	BOX QTY.	VOL. QTY.
R478300	1/4"	1/32"	15'	R479900	3/4"	1/16"	50'	1	2
R478400	1/4"	1/32"	25'	R480000	3/4"	1/16"	75'	1	2
R478500	1/4"	1/32"	50'	R480100	3/4"	1/16"	100'	1	2
R479000	1/2"	1/16"	25'	R480300	3/4"	1/8"	50'	1	2
R479100	1/2"	1/16"	50'	R480400	3/4"	1/8"	75'	1	2
R479200	1/2"	1/16"	75'	R480500	3/4"	1/8"	100'	1	2
R479300	1/2"	1/16"	100'					1	2
R479500	1/2"	1/8"	50'					1	2
R479600	1/2"	1/8"	75'					1	2
R479700	1/2"	1/8"	100'					1	2

SEWER TAPES

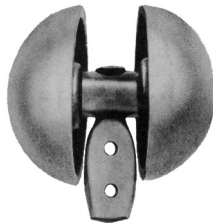

REPLACEMENT ROLLER HEADS

CAT. NO.	WIDTH OF HEAD	FOR TAPE SIZE	BOX QTY.	VOL. QTY.
R481200	1 1/4"	1/2" x 1/16", 3/4" x 1/16", 1/2" x 1/8"	1	6
R481300	2 1/4"	3/4" x 1/8", 1" x 1/8"	1	6
R481400	3"	3/4" x 1/8"	1	2

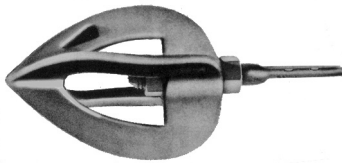

REPLACEMENT SPEAR HEADS

R481700	4 1/2"	3/4" x 1/8", 1" x 1/8"	1	2
---------	--------	------------------------	---	---

SNAKES

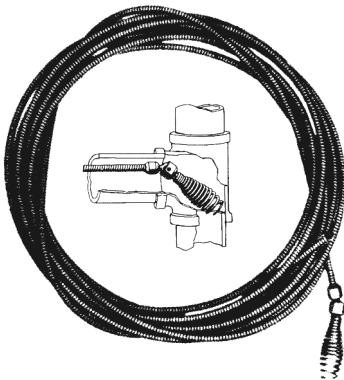









DROP-HEAD SNAKES

CAT. NO.	MFG. NO.	SIZE
R482000	PS-1415	1/4" x 15'
R482200	PS-1425	1/4" x 25'
R482300	PS-1430	1/4" x 30'
R482400	PS-1435	1/4" x 35'
R482500	PS-1450	1/4" x 50'
R482600	PS-1625	5/16" x 25'
R482700	PS-1635	5/16" x 35'
R482800	PS-1650	5/16" x 50'
R482900	PS-3825	3/8" x 25'
R483000	PS-3835	3/8" x 35'
R483100	PS-3850	3/8" x 50'
R483200	PS-3875	3/8" x 75'
R483300	PS-38100	3/8" x 100'
—	—	—
—	—	—
—	—	—

REINFORCED DROP-HEAD SNAKES

CAT. NO.	MFG. NO.	SIZE	BOX QTY.	VOL. QTY.
R484000	PSR-1415	1/4" x 15'	1	2
R484200	PSR-1425	1/4" x 25'	1	2
R484300	PSR-1430	1/4" x 30'	1	2
R484400	PSR-1435	1/4" x 35'	1	2
R484500	PSR-1450	1/4" x 50'	1	2
R484600	PSR-1625	5/16" x 25'	1	2
R484700	PSR-1635	5/16" x 35'	1	2
R484800	PSR-1650	5/16" x 50'	1	2
R484900	PSR-3825	3/8" x 25'	1	2
R485000	PSR-3835	3/8" x 35'	1	2
R485100	PSR-3850	3/8" x 50'	1	2
R485200	PSR-3875	3/8" x 75'	1	2
R485300	PSR-38100	3/8" x 100'	1	2
R485700	PSR-1250	1/2" x 50'	1	2
R485800	PSR-1275	1/2" x 75'	1	2
R485900	PSR-12100	1/2" x 100'	1	2

RICHARD SPECIALTY CO., INC.

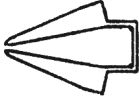
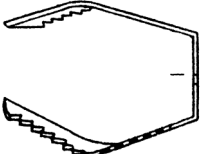
SNAKES	CAT. NO.	MFG. NO.	DESCRIPTION	BOX QTY.	VOL. QTY.
 R486000	R486000	DHT-14	1/4" Drop Heads with thimble eye	1	6
 R486100 to R486400	R486100	MDHT-516	5/16" Drop Heads w/male/female connector	1	6
	R486200	MDHT-38	3/8" Drop Heads w/male/female connector	1	6
	R486300	MDHT-716	7/16" Drop Heads w/male/female connector	1	6
	R486400	MDHT-12	1/2" Drop Heads w/male/female connector	1	6
 R486402	EXTRA HEADS FOR CHANGEABLE DROP HEAD SNAKES 5/16" x 25' THRU 5/16" x 50' & 3/8" x 25', 3/8" x 35'				
	R486402	MGSD-1	Small Drop Head w/male connector	1	6
 R486404	R486404	MGSS-1	Spear Head	1	6
	R486406	MGS-MBF	Multi blade fitting-straight type	1	6
 R486406	R486408	MGD-MBF	Multi blade fitting-drop type	1	6
	R486412	MGSC-516	5/16" female connector w/roll pin	1	6
	R486414	MGSC-38	3/8" female connector w/roll pin	1	6
 R486420	EXTRA HEADS FOR CHANGEABLE DROP HEAD AND CUTTER HEADS SNAKES 3/8" x 50' THRU 1/2" x 100'				
	R486420	MGSD-2	Heavy duty drop head w/male connector	1	6
 R486422	R486422	MGSS-1	Spear Head	1	6
	R486406	MGS-MBF	Multi blade fitting-straight type	1	6
 R486406	R486408	MGD-MBF	Multi blade fitting-drop type	1	6
	R486424*	SPB-1	Star point borer	1	6
	R486426*	SPT-3	2 3/8" O.D. serrated cutter	1	6
	R486428*	SPT-4	2 3/4" O.D. serrated cutter	1	6
	*Need R486406 or R486408 to attach these heads.				
 R486424	R486437	MGSC-716	7/16" female connector w/roll pin	1	6
	R486440	MGSC-12	1/2" female connector w/roll pin	1	6
 R486426 - R486428					

SNAKES

CAT.
NO.

MFG.
NO.

SIZE

BOX VOL.
QTY. QTY.

BASIN PLUG SNAKES

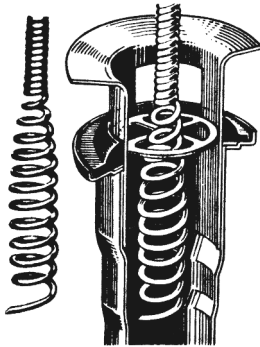

R486500	PBS-1415	1/4" x 15'	1	2
R486600	PBS-1420	1/4" x 20'	1	2
R486700	PBS-1425	1/4" x 25'	1	2
R486900	PBS-1435	1/4" x 35'	1	2
R487000	PBS-1450	1/4" x 50'	1	2
R487100	PBS-1625	5/16" x 25'	1	2
R487200	PBS-1635	5/16" x 35'	1	2
R487300	PBS-1650	5/16" x 50'		

REINFORCED BASIN PLUG SNAKES



R487700	PBSR-1415	1/4" x 15'	1	2
R487900	PBSR-1425	1/4" x 25'	1	2
R488100	PBSR-1435	1/4" x 35'	1	2
R488200	PBSR-1450	1/4" x 50'	1	2
R488300	PBSR-1625	5/16" x 25'	1	2
R488400	PBSR-1635	5/16" x 35'	1	2
R488500	PBSR-1650	5/16" x 50'	1	2

REPLACEMENT CUTTER

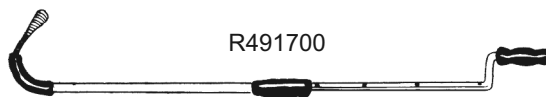

R490800	PTF-21	1" O.D.	1	6
R490900	PTF-22	1 1/8" O.D.	1	6
R491000	PTF-23	1 3/8" O.D.	1	6
R491100	PTF-24	1 5/8" O.D.	1	6
R491200	PTF-25	1 3/4" O.D.	1	6

REGULAR CLOSET AUGERS

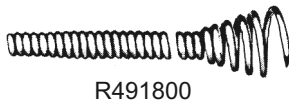

R491700	PRO-X-36	3'-6' Extendo closet auger	1	6*
R491800	REX-36	Refill wire for PRO-X-36	1	6*

T-BOWL SHIELD



491850		T-Bowl shield	1	3
--------	--	---------------	---	---



RICHARD SPECIALTY CO., INC.

SNAKES	CAT. NO.	MFG. NO.	DESCRIPTION	BOX QTY.	VOL. QTY.
--------	----------	----------	-------------	----------	-----------

R492100



R492200

DROP HEAD CLOSET AUGERS

R492100 PRO-X-36D 3'-6' Extendo drop head closet auger in 10" steps 1 6*

R492200 REX-36-DH Refill wire PRO-X-36D 1 6*

*May Be Assorted For Volume Quantity.

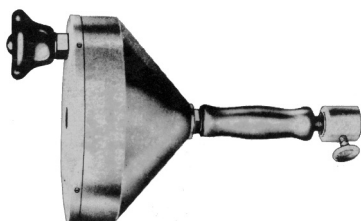

SNAKE HOUSES

R492800 PH-4 1/4" Handy Snake House offset turning model. (no snake) 1 2

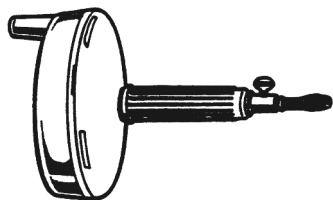

R493000 Little Mike w/ 1/4" x 15' 1 5
R493100 Big Dave w/ 1/4" x 25' 1 5

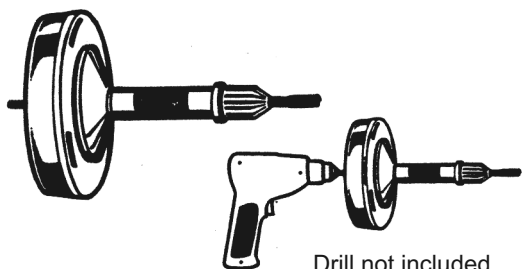

Drill not included

PULSE AUGER (Drill not included)

R493200 Pulse Auger with Spin Dry/Oil Feature. Comes with 1/4" x 20' music wire cable. Cleans pipes through 2". 1 2

DIELECTRIC UNIONS	CAT. NO.	DESCRIPTION	BOX QTY.	VOL. QTY.
-------------------	----------	-------------	----------	-----------

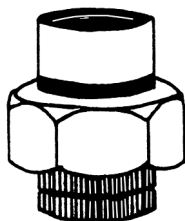

DIELECTRIC UNIONS-STEEL

R493500 1/2" F.I.P. x 1/2" solder 1 24*
R493600 3/4" F.I.P. x 3/4" solder 1 24*
R493700 1" F.I.P. x 1" solder 1 24*
R493800 1 1/4" F.I.P. x 1 1/4" solder 1 24*
R493900 1 1/2" F.I.P. x 1 1/2" solder 1 24*
R494000 2" F.I.P. x 2" solder 1 24*
R494100 3/4" F.I.P. x 1/2" solder 1 24*
R494200 3/4" M.I.P. x 3/4" solder 1 24*

*May Be Assorted For Volume Quantity.

FREEZE FREE SELF REGULATING PIPE HEATING SYSTEM



R496150-
R496210

FREEZE FREE® CABLE

CAT. NO.	MFG. NO.	DESCRIPTION	BOX QTY.	VOL. QTY.
R496150	2102	100' Reel	1	2
R496200	2302	300' Reel	1	2
R496210	2502	500' Reel	1	2



R496250

R496250	10803	Plug & End Seal Connector Kit	1	6
---------	-------	-------------------------------	---	---



R496350

R496300	4102	100' Display with 10-10803 Kit	1	-
R496350	4302	300' Display with 20-10803 Kit	1	-

ROOF DE-ICER KITS

CAT. NO.	MFG. NO.	SIZE	BOX QTY.	VOL. QTY.
----------	----------	------	----------	-----------

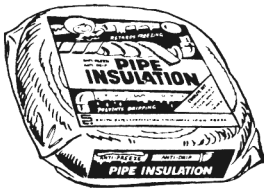

ROOF DE-ICER KITS With hardware, no thermostat.

Prevent frozen eaves, gutters and spouts.

120 VAC with 6 ft. cold lead



R497000	CRK-20	20' Roof Kit	1	10
R497100	CRK-30	30' Roof Kit	1	10
R497200	CRK-40	40' Roof Kit	1	10
R497300	CRK-60	60' Roof Kit	1	6
R497400	CRK-80	80' Roof Kit	1	6
R497500	CRK-100	100' Roof Kit	1	6
R497600	CRK-120	120' Roof Kit	1	6
R497700	CRK-140	140' Roof Kit	1	6

RICHARD SPECIALTY CO., INC.

PEX CLAMP & CRIMP RINGS

CAT. NO.	MFG. NO.	SIZE	BOX QTY.	VOL. QTY.
----------	----------	------	----------	-----------



BRASS (COPPER) PEX CRIMP RING

R498250		3/8"	100	1000
R498251		1/2"	100	1000
R498252		3/4"	100	1000
R498253		1"	100	1000



OETIKER PEX STAINLESS STEEL CLAMP

Heavy duty 304 stainless steel
The original patented pex assembly clamp designated by ASTM F 2098
Ingenious stepless design provides uniform compression for a 360° watertight seal

R498255		3/8"	100	2000
R498256		1/2"	100	2000
R498257		3/4"	50	2000
R498258		1"	50	1000

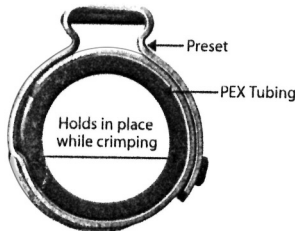

OETIKER PEX GRIP STAINLESS STEEL CLAMP

Preset to prevent clamp from sliding; Grips tube for easy installation;
Shortens tool stroke; 360° stepless design; Certified by NSF to meet NSF/ANSI 14 requirements; Narrow band for concentrated seal compression; Requires only one installation tool for all clamp sizes;
Fast, simple and secure installation; Tamper-detectable design

R498260		1/2"	100	2000
R498265		3/4"	100	2000
R498267		1"	100	2000



PEX PINCH CLAMPS

NSF Listed to ASTM F209
Safe for potable water and radiant floor heating
Made with heavy duty 304 stainless steel

R498270		1/2"	100	2000
R498271		3/4"	100	2000
R498272		1"	100	2000

POLYBUTYLENE CRIMPING TOOL

CAT. NO.	MFG. NO.	DESCRIPTION	BOX QTY.	VOL. QTY.
----------	----------	-------------	----------	-----------

R498300
R498310
R498320



POLYBUTYLENE CRIMPING TOOLS

Units can be calibrated in field.

R498300	9202STS	1/2" Regular crimping tool	1	2
R498310	9203STS	3/4" Regular crimping tool	1	2
R498320	9204STM	1" Regular crimping tool	1	2

** STS - 12" Tool length, STM - 16" Tool length

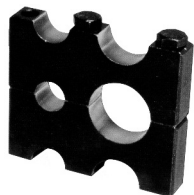

R498325

R498325	9260STD	3/8" - 1" Screwdriver crimp tool	1	2
---------	---------	----------------------------------	---	---

R498330



R498330	9306STM	1/2" & 3/4" Combo crimping tool, 14"	1	2
---------	---------	--------------------------------------	---	---

POLYBUTYLENE CRIMPING TOOL

CAT. NO.	MFG. NO.	DESCRIPTION	BOX QTY.	VOL. QTY.
----------	----------	-------------	----------	-----------



POLYBUTYLENE CRIMPING TOOLS

Units can be calibrated in field.

R498334	9354SASK	3/8" - 1" Interchangeable dies, metal handle, kit, includes case	1	2
R498335	9358SAK	3/8" - 1" Interchangeable dies, composite handle, kit, includes case	1	2
R498337	7302ES DP	1/2" Offset crimping tool	1	2
R498339	7303ES DP	3/4" Offset crimping tool	1	2
R498340	7306ES DP	1/2" + 3/4" Offset crimping tool	1	2
R498341	7407ES DP	Ring removal tool - USA	1	2

PINCH TOOLS FOR PEX STAINLESS STEEL CLAMPS

R498343	9252SCPDP	3/8" - 1" Stainless steel sleeve pincer, 2-handle	1	2
R498345	9253SCPDP	3/8" - 1" Stainless steel sleeve pincer, 3-handle	1	2
R498346	9251SCPDP	3/8" - 1" Economy pinch tool, rated for 5000 crimps	1	2
R498347	9504QCDP	1/2" - 3/4" Quick-cut PEX radial cutter; straight cut, flat cut every time	1	2
R498349	9255PRT	Socket for SS clamp remover	1	2

POLYBUTYLENE DECRIMPING TOOL

RINGBUSTER® takes the work out of removing crimp rings and PEX tube from 1/2", 3/4" and 1" fittings. Stop wasting time using a hacksaw or torch, and stop throwing away expensive PEX fittings.

R498350	73015	RINGBUSTER®	1	5
R498360	73020	Display of 10 R498350	1	2

RICHARD SPECIALTY CO., INC.

STAINLESS SLEEVE PEX TOOLS

CAT. NO.	MFG. NO.	SIZE	BOX QTY.	VOL. QTY.
----------	----------	------	----------	-----------

These tools (below) form two unique circular grooves necessary for leak-free press connections.

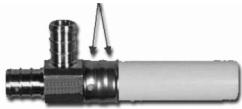

R498365 9222SSS 1/2" 12" Steel handle 1 2



R498365 R498366 9223SSS 3/4" 12" Steel handle 1 2



R498366 R498367 9224SSL 1" 19" Steel handle 1 2



R498367 R498368 9228SSL 1-1/4" 19" Steel handle 1 2



R498370 R498370 9226SSM 1/2" & 3/4" 16" Combo tool 1 2

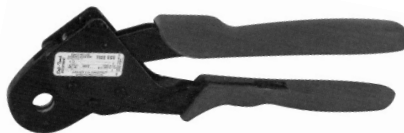

R498375 R498375 7322ES 1/2" Compact offset crimping tool 1 2



R498380 9358SAKSS 1/2", 3/4" Stainless steel sleeve with 1" copper crimper 1 2

R498380

"JET SWET"

CAT. NO.	MFG. NO.	SIZE	BOX QTY.	VOL. QTY.
----------	----------	------	----------	-----------

"Solder without draining the entire water system!"

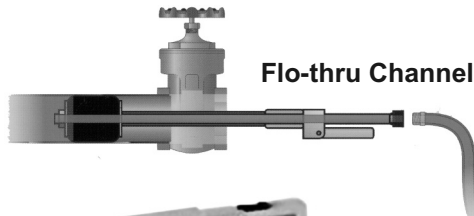

Flo-thru Channel



R498490



R498495



R498600 - R498640

JET SWET

R498400	050	1/2"	1	6*
R498405	075	3/4"	1	6*
R498410	100	1"	1	6*
R498415	125	1 1/4"	1	6*
R498420	150	1 1/2"	1	6*
R498425	200	2"	1	6*
R498430	250	2 1/2"	1	6*
R498435	300	3"	1	6*
R498440	400	4"	1	6*

*May Be Assorted For Volume Quantity.

FLO-THRU

R498454	5095	1/2"	1	3*
R498456	7595	3/4"	1	3*
R498458	1095	1"	1	3*
R498460	1495	1 1/4"	1	3*
R498462	1295	1 1/2"	1	3*
R498464	2095	2"	1	3*
R498466	295	2 1/2"	1	3*
R498468	395	3"	1	3*
R498470	495	4"	1	3*
R498475	595	5"	1	3*
R498480	695	6"	1	3*

*May Be Assorted For Volume Quantity.

R498490	6800	1 ea. 1/2" to 2" Tools & replacement gaskets with carrying case	1	4*
R498495	2800	1 ea. 1/2" to 1" Tools & replacement gaskets in carrying case	1	4*
R498500	6100	1/2" thru 2" with carrying case	1	4*
R498505	4800	1 ea. 1 1/4" thru 2" Tools and replacement gaskets in carrying case	1	4*
R498510	2100	1/2" thru 1" with carrying case	1	4*
R498515	2000	1/2" thru 1" less case	1	4*
R498520	7000	carrying case only	1	4*
R498530	3000	1/2" with gasket nuts and washers for 3/4" & 1"	1	4*

*May Be Assorted For Volume Quantity.

REPLACEMENT GASKETS

R498600	012	1/2" Gasket	1	12*
R498605	034	3/4" Gasket	1	12*
R498610	101	1" Gasket	1	12*
R498615	114	1 1/4" Gasket	1	12*
R498620	112	1 1/2" Gasket	1	12*
R498625	202	2" Gasket	1	12*
R498630	212	2 1/2" Gasket	1	12*
R498635	303	3" Gasket	1	12*
R498640	404	4" Gasket	1	12*
R498642	505	5" Gasket	1	12*
R498644	606	6" Gasket	1	12*

*May Be Assorted For Volume Quantity.

"JET SWET"	CAT. NO.	MFG. NO.	SIZE	BOX QTY.	VOL. QTY.
-------------------	----------	----------	------	----------	-----------



FLO-THRU REPLACEMENT GASKETS

R498654	5033	1/2" Flo-thru gasket	1	3*	
R498656	7533	3/4" Flo-thru gasket	1	3*	
R498658	1033	1" Flo-thru gasket	1	3*	
R498660	1433	1 1/4" Flo-thru gasket	1	3*	
R498662	1015	1 1/2" Flo-thru gasket	1	3*	
R498664	1020	2" Flo-thru gasket	1	3*	
R498666	220	2 1/2" Flo-thru gasket	1	3*	
R498668	330	3" Flo-thru gasket	1	3*	
R498670	440	4" Flo-thru gasket	1	3*	
R498672	550	5" Flo-thru gasket	1	3*	
R498674	660	6" Flo-thru gasket	1	3*	
*May Be Assorted For Volume Quantity.					
R498680	1751	Repair kit (washers & gaskets for 1/2", 3/4" & 1")	1	3	
R498685	6751	Repair kit (1/2" to 2" washers & gaskets)	1	3	
R498690	6278	1oz. Jet Swet Grease	1	3	

WASSI PLUGGING KITS



CAT. NO.	MFG. NO.	DESCRIPTION	BOX QTY.	VOL. QTY.
R498800	5221	Wassi kit 1/2" to 2"	1	4*
R498805	5220	Wassi kit 1/2" to 1"	1	4*
*May Be Assorted For Volume Quantity.				
R498810	5227	1/2" Wassi cable assembly	1	6*
R498815	5228	3/4" Wassi cable assembly	1	6*
R498820	5229	1" Wassi cable assembly	1	6*
R498825	5230	1 1/4" Wassi cable assembly	1	6*
R498830	5231	1 1/2" Wassi cable assembly	1	6*
R498835	5232	2" Wassi cable assembly	1	6*
R498840	5226	Wassi replacement handle	1	6*
*May Be Assorted For Volume Quantity.				

RADIATOR VALVE TOOL

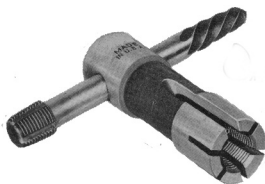

3 IN 1 RADIATOR VALVE TOOL

CAT. NO.	DESCRIPTION	BOX QTY.	VOL. QTY.
R499000	1/8" Pipe Tap and Screw Extractor for removing 1/8" pipe. 1/8" Pipe die in body.	1	6

LEAD CLEANOUT PLUGS

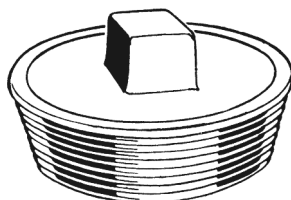

CAT. NO.	SIZE	BOX QTY.	VOL. QTY.
LEAD "TAKE ALL" CLEANOUT PLUGS			
R499400	2"	1	6
R499500	2 1/2"	1	6
R499600	3"	1	6
R499700	3 1/2"	1	6
R499800	4"	1	6
R499900	4 1/2"	1	6
R500000	5"	1	6
R500100	6"	1	6

PIPE THAWING

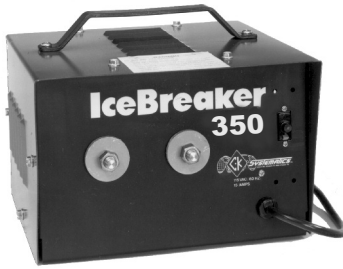

PIPE THAWING EQUIPMENT

ICEBREAKER™ 350 (Superlite)

CAT. NO.	MFG. NO.	DESCRIPTION	BOX QTY.	VOL. QTY.
R501700	IB-350	IceBreaker less output cables	1	5*
R501800	IB-350-20-2	IceBreaker w/2-20' #2 cables	1	5*
R501900	IB-350-50-2/0	IceBreaker w/2-50' #2/0 cables	1	5*
R502000	IB-350-100-2/0	IceBreaker w/2-100' #2/0 cables	1	5*



ICEBREAKER™ 450 (Super Hot)

CAT. NO.	MFG. NO.	DESCRIPTION	BOX QTY.	VOL. QTY.
R502200	IB-450	IceBreaker less output cables	1	5*
R502300	IB-450-20-2	IceBreaker w/2-20' #2 cables	1	5*
R502400	IB-450-50-2	IceBreaker w/2-50' #2 cables	1	5*
R502500	IB-450-50-2/0	IceBreaker w/2-50' #2/0 cables	1	5*
R502600	IB-450-100-2/0	IceBreaker w/2-100' #2/0 cables	1	5*

*May Be Assorted For Volume Quantity.

*Check Price Sheet For Additional Volume Pricing.

CAT. NO.	MFG. NO.	LENGTH	BOX QTY.	VOL. QTY.
----------	----------	--------	----------	-----------

REPLACEMENT CABLE FOR ICEBREAKERS

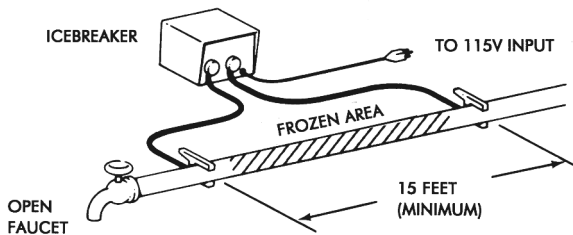

R503000	20-2	20 Ft. cable	1	-
R503100	50-2	50 Ft. cable	1	-
R503200	20-2/0	20 Ft. cable	1	-
R503300	50-2/0	50 Ft. cable	1	-
R503400	100-2/0	100 Ft. cable	1	-
R503500	50-4/0	50 Ft. cable	1	-
R503600	100-4/0	100 Ft. cable	1	-

REPLACEMENT CLAMPS FOR ICEBREAKERS

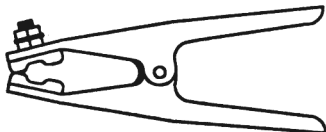

R503700		1/2" - 1 1/2" Pipe clamp	1	-
R503710		1 1/2" - 3" Pipe clamp	1	-
R503720		4" - 6" Pipe clamp	1	-

CAT. NO.	MFG. NO.	DESCRIPTION	BOX QTY.	VOL. QTY.
----------	----------	-------------	----------	-----------

GASKET CUTTER



R504000	760	Gasket cutter 1/4"-6"	1	2
R504370	B-176	Kit of 6 - B-17 blades	1	2
R504375	B-256	Kit of 6 - B-25 blades	1	2

RICHARD SPECIALTY CO., INC.

HOSE CONNECTORS

CAT.
NO.

SIZE

BOX
QTY. VOL.
QTY.

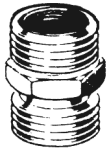

R504500

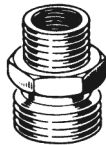

R504600



R504700



R504800



R505000 & R505100

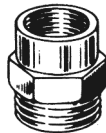

R504900

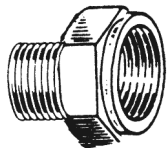

R505200
R505300
R505350

SOLID BRASS

CAT. NO.	SIZE	BOX QTY.	VOL. QTY.
R504500	3/4" MHT x 3/4" MHT	1	24
R504600	3/4" MHT x 1/2" MIP	1	24
R504700	3/4" MHT x 3/4" MIP x 1/2" FIP	1	24
R504800	3/4" MHT x 1/2" FIP	1	24
R504900	3/4" MHT x 3/4" FIP	1	24
R505000	3/4" FHT x 1/2" FIP	1	24
R505100	3/4" FHT x 3/4" FIP	1	24
R505200	3/4" FHT x 1/2" MIP	1	24
R505300	3/4" FHT x 3/4" MIP	1	24
R505350	3/4" FHT x 3/4" MIP x 1/2" FIP	1	24

R505400
R505600



SWIVEL TYPE

CAT. NO.	SIZE	BOX QTY.	VOL. QTY.
R505400	3/4" FHT x 1/2" FIP	1	24
R505500	3/4" FHT x 3/4" FIP	1	24
R505600	3/4" FHT x 3/4" FHT	1	24

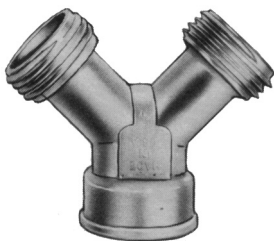

R506000

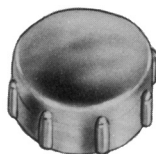

R506100

BRASS PLATED

CAT. NO.	SIZE	BOX QTY.	VOL. QTY.
R506000	Siamese Garden Hose Y	1	24
R506050	Siamese Conn. w/Shut-off	1	24
R506100	Hose Cap	1	100
R506200	3/4" Hose Washers	1	100



R506200

FLOOR DRAIN COVERS

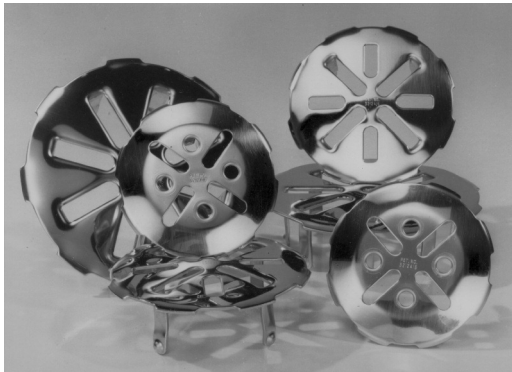

STAINLESS STEEL (Heavy Duty)

CAT. NO.	MFG. NO.	FOR PIPE SIZE	BOX QTY.	VOL. QTY.
R506500	186-2	1" to 1 1/2"	1	24*
R506600	186-3	2"	1	24*
R506700	186-4	3"	1	24*
R506800	186-5	4"	1	24*

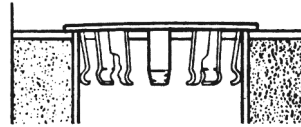

*See Price Sheet For Additional Volume Quantity.

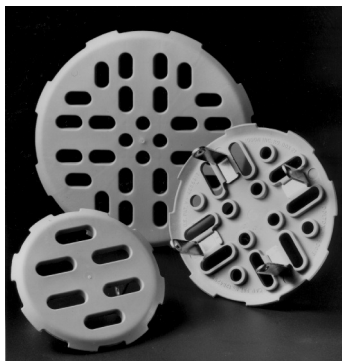

GLASS-FILLED NYLON

With Insertable Stainless Legs (Wears Like Steel)

R506805	286-3P	2"	1	24
R506810	286-4P	3"	1	24
R506815	286-5P	4"	1	24

FLOAT BALLS

CAT. NO.	DESCRIPTION	BOX QTY.	VOL. QTY.
----------	-------------	----------	-----------

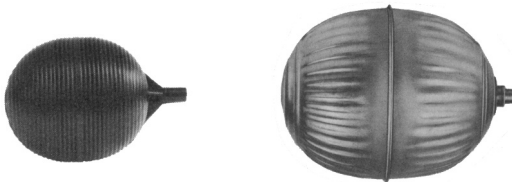

TOILET TANK FLOAT BALL

R507000	Standard high impact plastic non-corrosive	(1)100	100
R507050	Copper 4" x 5"	1	100

DRUM TRAP COVER

CAT. NO.	DESCRIPTION	BOX QTY.	VOL. QTY.
----------	-------------	----------	-----------



DRUM TRAP COVER

R507200	Cover with gasket - chrome	(1)110	220
R507300	Gasket only	100	200

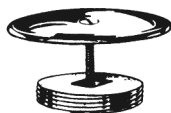

R507400



R507405

R507400	Extension type-stainless steel cover with 3" countersunk plug	1	50
---------	---	---	----

R507405	Self adjusting style A	1	50
---------	------------------------	---	----

RICHARD SPECIALTY CO., INC.

DRUM TRAP COVER



CAT. NO.	CAT. NO.	DESCRIPTION	BOX QTY.	VOL. QTY.
POLISHED STAINLESS STEEL EXTENSION COVERS WITH 1/4" x 2 1/4" C.P. STEEL BOLT				
Wall Mount (24GA)	Floor Mount (16GA)			
R507412	R507465	3"	1	12
R507415	R507470	4"	1	12
R507420	R507475	5"	1	12
R507425	R507480	6"	1	12
R507427	R507485	7"	1	12
R507430	R507490	8"	1	12
R507435	R507495	10"	1	12
R507440		12"	1	12
R507445		14"	1	12



1/4" CHROME PLATED BOLTS FOR STAINLESS STEEL EXTENSION COVERS				
R507450		2 1/2" Length	1	12
R507455		4" Length	1	12
R507460		6" Length	1	12

BRACKETS

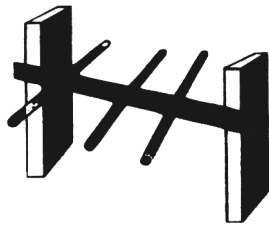

CAT. NO.	MFG. NO.	DESCRIPTION	BOX QTY.	VOL. QTY.
BRACKETS - STUB OUT BARS - (Copper Plated)				
R508100	MS-500-18	18" Long for 1/2" tubing	50	500
R508105	MS-500-20	20" Long for 1/2" tubing	50	500
R508110	MS-500-26	26" Long for 1/2" tubing	50	500



R508200 - R508300 - R508400

MULTI-SIZE BRACKETS FOR 1/2", 3/4" & 1" TUBING ON 2" CENTERS - (Copper Plated)				
R508200	MS-18	18" Long	50	500
R508300	MS-20	20" Long	50	500
R508400	MS-26	26" Long	50	500

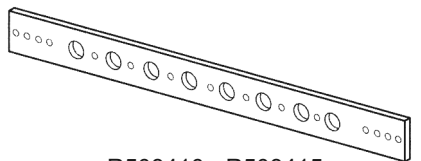

R508410 - R508415

(1/2" HOLES ON 2" CENTERS)				
R508410	PS-10120	20" Long	50	500
R508415	PS-10126	26" Long	50	500

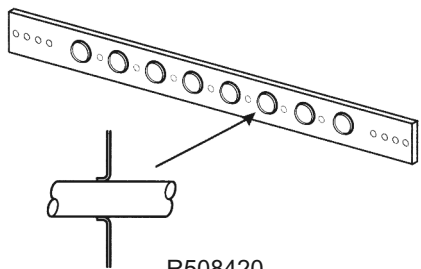

R508420

(1/2" EXTRUDED HOLES ON 2" CENTERS)				
R508420	PS-10120-R	20" Long	50	500

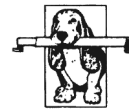

BRACKETS

CAT. NO.	MFG. NO.	DESCRIPTION	BOX QTY.	VOL. QTY.
----------	----------	-------------	----------	-----------

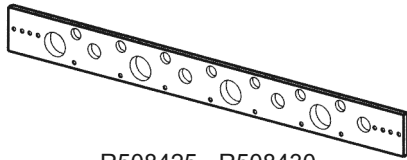

R508425 - R508430

MULTI-SIZE BRACKETS FOR 1/2", 3/4" & 1" TUBING ON 2" CENTERS - (Copper Plated)

(1/2" HOLES ON 2" CENTERS)
 (3/4" HOLES ON 4" CENTERS)
 (1" HOLES ON 4" CENTERS)

R508425	PS-10720	20" Long	50	500
R508430	PS-10726	26" Long	50	500

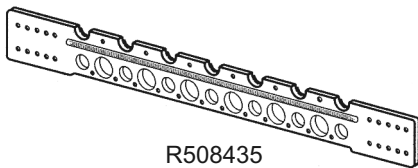

R508435

"DO ALL" BRACKET

(1/2" SNAP-IN WITH EXTRUDED SURFACE ON 2" CENTERS)
 (1/2" & 3/4" EXTRUDED HOLES ON 2" CENTERS)

R508435	PS-14820-R	20" Long	50	500
---------	------------	----------	----	-----

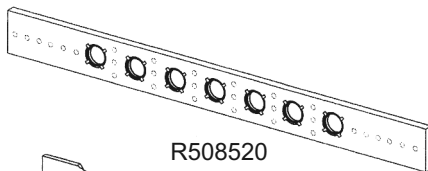

R508520

BASSET INDUSTRIAL STUB OUT BARS (Galvanized) ACCEPTS PLASTIC INSERTS 1/2", 3/4" & 1"

HOLE SIZE 1-11/32" CENTERS
 (ACCEPTS PLASTIC INSERTS 1/2", 3/4" & 1")
 HOLE SIZE 1-11/32" ON 2" CENTERS)

R508500	IS-18	18" Long	50	500
R508520	IS-20	20" Long	50	500
R508550	IS-26	26" Long	50	500

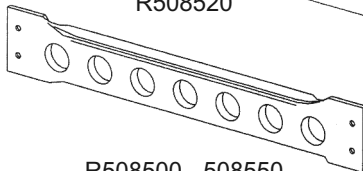

R508500 - 508550

CAT. NO.	MFG. NO.	DESCRIPTION	BOX QTY.	VOL. QTY.
----------	----------	-------------	----------	-----------



R508560



R508565



R508570

PIPE INSULATORS

FOR COPPER OR POLY PIPES

HOLE SIZE 1 11/32"

R508560	PI-500-5	1/2"	100	1000
R508565	PI-750-5	3/4"	100	1000
R508570	PI-1000-5	1"	100	1000

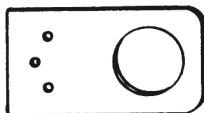

R508560

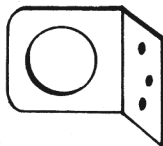

R508565

BASSET INDUSTRIAL BRACKETS (Galvanized)

(WITH 3 NAIL HOLES - HOLE SIZE 1 11/32"

ACCEPTS PLASTIC INSERTS 1/2", 3/4" & 1")

R508575	FB-44	Flat bracket	100	500
R508580	AB-42	Angle bracket	100	500

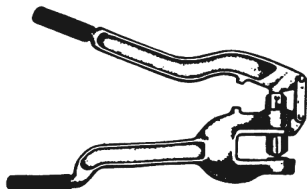

METAL STUD PUNCH - CUTS 20 GA. STEEL

R508585	ETSP-5	Hole size 1 11/32"	1	2
---------	--------	--------------------	---	---

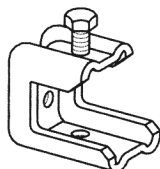

R508610

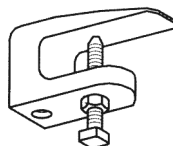

R508620-
R508625

BEAM CLAMP

R508610	BBC-5	With 1/4-20 x 1" hex head slotted screw and locknut	50	100
R508620	380-5	3/8" with locknut	100	500
R508625	500-5	1/2" with locknut	100	500

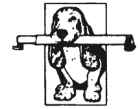

BRACKETS

CAT. NO.	MFG. NO.	DESCRIPTION	BOX QTY.	VOL. QTY.
----------	----------	-------------	----------	-----------

CARRIER BRACKET

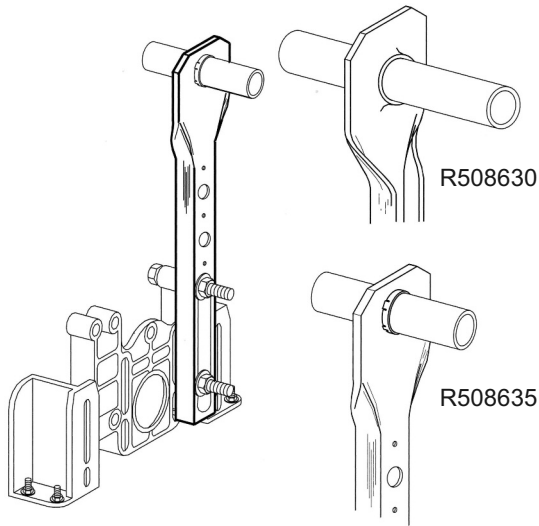

R508630	BCB-C	Copper plated w/extruded hole for direct soldering of 1" copper pipe	10	40
---------	-------	--	----	----

R508635	BCB-G	Galvanized bracket includes 1" plastic insert	10	40
---------	-------	---	----	----

PIPE POSITIONING BRACKET WITH STEEL CLAMP

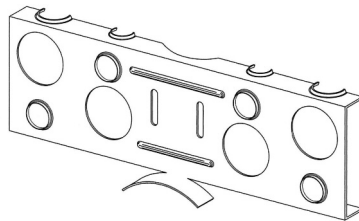

R508640	PPB	Provides snap-in or extruded holes for 1/2" or 3/4" copper supply pipes on 4" & 8" centers	25	50
---------	-----	--	----	----

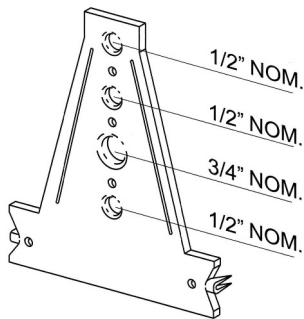

COPPER PLATED WATER CLOSET BRACKET SELF NAILER

R508645	WCB	Functions as nail plate	25	50
R508650	WCB-M	Holes only for metal studs	25	50

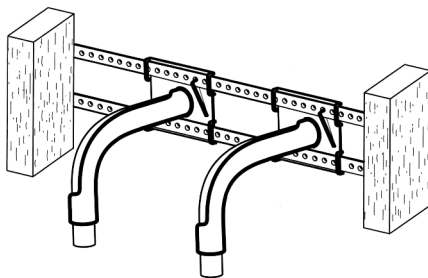

HYCO PEX MOUNTING - KIT

- Eliminate in-wall fittings & joints
- Fast & economical method of stubbing-out PEX tubing
- Self-locking tab must be compressed tightly to bracket with pliers

R508700	HPA-500	1/2"	25 - Brackets 50 - 18" Hyco Bars	1	2
R508705	HPA-750	3/4"	25 - Brackets 50 - 18" Hyco Bars	1	2

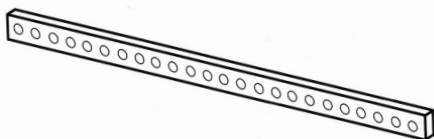

HYCO BAR

R508710	HY-118	18" Galvanized Steel	100	300
R508715	HY-120	20" Galvanized Steel	100	300
R508720	HY-126	26" Galvanized Steel	100	300

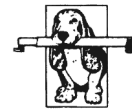

BASSET BRACKETS

CAT.
NO.

MFG.
NO.

DESCRIPTION

BOX
QTY.

VOL.
QTY.

R508725 -
R508740

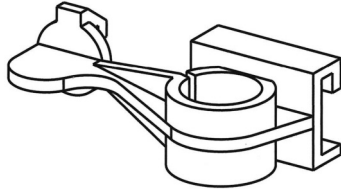
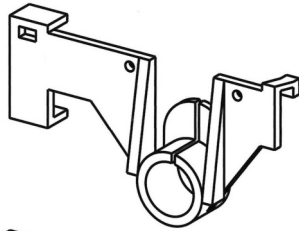

R508745
R508750

HYCO BAR SUPPORTS

R508725	HY12H-5	1/2" Horizontal Insulator	50	100
R508730	HY34H-5	3/4" Horizontal Insulator	50	100
R508735	HY12V-5	1/2" Vertical Insulator	50	100
R508740	HY34V-5	3/4" Vertical Insulator	50	100
R508745	HY12H-CPVC-5	1/2" Horizontal Insulator	50	100
R508750	HY34H-CPVC-5	3/4" Horizontal Insulator	50	100

HYCO PEX BRACKET

- Fast & economical method of stubbing-out PEX tubing
- Self-locking tab must be compressed tightly to bracket with pliers

R508755	HP-500	1/2"	25	100
R508760	HP-750	3/4"	25	100

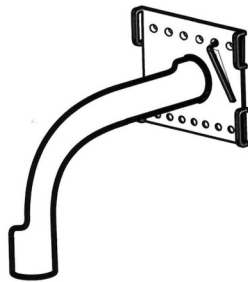

PEX SIDEWINDER WITH MOUNTING PLATE

- Unique open corner on mounting plate allows bracket to be added anytime along PEX tubing
- Connection free stub out for PEX tubing

R508765	PSB-500	3/8" & 1/2" Galvanized Steel	25	100
R508770	PSB-750	3/4" Galvanized Steel	25	100
R508775	PSB-500P	3/8" & 1/2" PVC	25	100

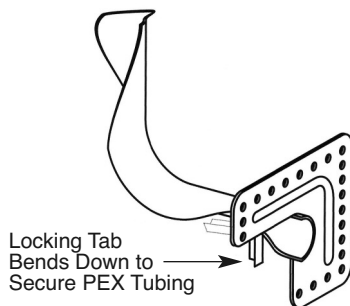

PEX SUPPORT 90° BEND

- Holds PEX tubing firmly to prevent kinking
- Forms tight 90 degree bends in PEX tubing
- Bend support edges are burr free. No sharp edges for PEX to rub against

R508780	BS-1-500	1/2" Galvanized Steel	50	200
R508785	BS-1-750-5	3/4" Galvanized Steel	50	200
R508790	BS-1-1000-5	1" Galvanized Steel	50	200

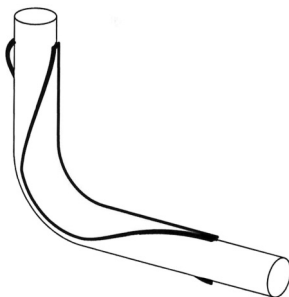

GALVANIZED BASSET BRACKETS

R513000	A-125	Galvanized 12"-19"	25	250
R513100	A-150	Galvanized 12"-19"	50	500
R513200	E-125G	19"-26" Galvanized	25	250

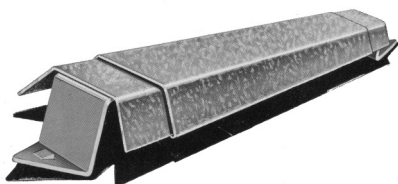

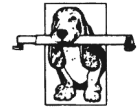

BASSET BRACKETS

CAT. NO.

MFG. NO.

DESCRIPTION

BOX QTY. VOL. QTY.

TAB BRACKETS

R513210	AT-125	Galvanized 12"-19"	25	250
R513220	AT-150	Galvanized 12"-19"	50	500
R513230	ET-125-G	Galvanized 19"-26"	50	500
R513232	CT-125	Copper plated 12"-19"	25	250
R513234	ET-125-C	Copper plated 19"-26"	25	250

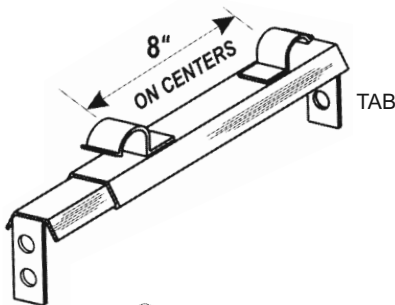
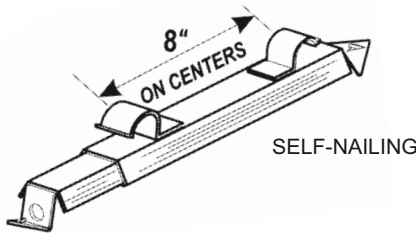
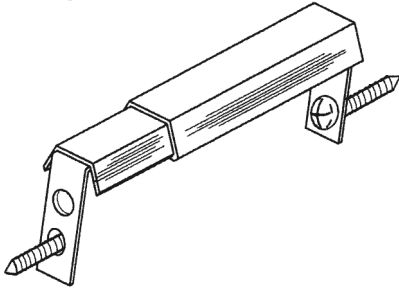
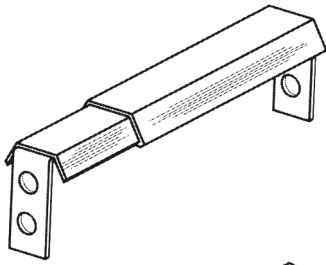

TAB BRACKETS WITH PRE-LOADED SCREWS

R513235	ATS-125	Galvanized 12"-19"	25	250
R513236	ATS-150	Galvanized 12"-19"	50	500
R513237	CTS-125	Copper Plated 12"-19"	25	250
R513238	ETS-125G	Galvanized 19"-26"	25	250
R513239	ETS-125C	Copper Plated 19"-26"	25	250

"PEX" BRACKET

R513240	A-125-P	Galvanized 12"-19"	25	250
R513242	E-125-P	Galvanized 19"-26"	25	250

"PEX" TAB BRACKET

R513246	AT-125-P	Galvanized 12"-19"	25	250
R513248	ET-125-P	Galvanized 19"-26"	25	250

SNAP N' SLIDE BRACKET

*CPVC Tubing can be glued to clamp

R513260	SSAI-12	1-Self-Nailing Bracket w/2-1/2" clamps	25	250
R513262	SSAI-34	1-Self-Nailing Bracket w/2-3/4" clamps	25	250
R513264	SSAT-12	1-Tab Bracket w/2-1/2" clamps	25	250
R513266	SSAT-34	1-Tab Bracket w/2-3/4" clamps	25	250

(Clamp snaps on to bracket then slide to position.)
(Clamps are available in 1/2" and 3/4")

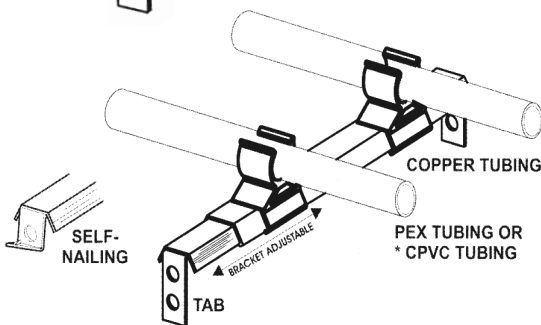

SNAP N' SLIDE BRACKET

R513270	SSC-12	1-1/2" SNAP N' SLIDE clamp	50	500
R513272	SSC-34	1-3/4" SNAP N' SLIDE clamp	50	500

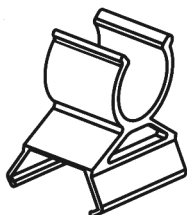

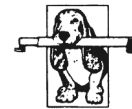

BASSET BRACKETS

CAT. NO.

MFG. NO.

DESCRIPTION

BOX QTY.

VOL. QTY.

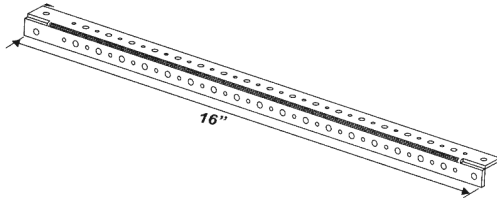

PERFORATED ANGLE MOUNTING BRACKET (16" Long x 1/2" x 1/2")

R513280	AMB-1	Brite Zinc Plated Steel 20 ga.	50	500
R513282	AMB-1C	Copper plated steel 20 ga.	50	500

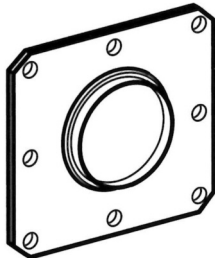

R513284



R513290

PIPE SOLDER CLIPS

Solder clips provide a variety of options when installing copper tubing

R513284	SCQ-12	1/2"	100	300
R513286	SCQ-34	3/4"	100	300
R513288	SCQ-100	1"	100	300
R513290	SCR-12	1/2"	100	300
R513292	SCR-34	3/4"	100	300

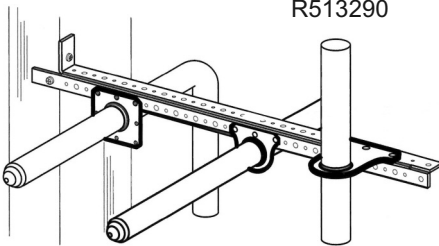

PIPE SOLDER CLIPS IN USE

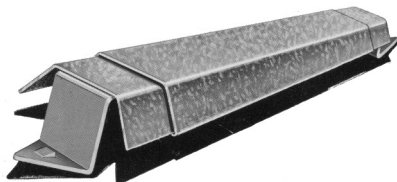

COPPER PLATED BASSET BRACKETS

R513300	C-125	Copper plated 12"-19"	25	250
R513400	E-125C	Copper plated 19"-26"	25	250

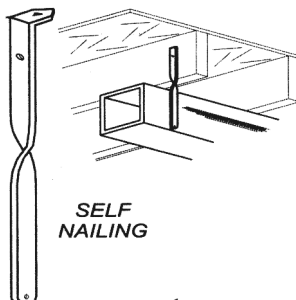

SELF NAILING

DUCT STRAP

R513500	DS-3	Duct Strap. For all square duct run below the joist.	100	500
---------	------	--	-----	-----

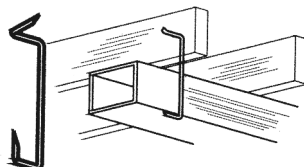

WIRE DUCT STRAPS

R513590	GWS-49	9 Ga. Galvanized wire 9"	100	500
R513600	GWS-412	Wire Duct Strap. No nails, screws or rivets. For all square duct run below the joist. 9" ga. wire, hammers into duct & joist. 9 Ga. Galvanized wire 12"	100	500

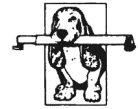

BASSET BRACKETS

CAT. NO.

MFG. NO.

DESCRIPTION

BOX QTY.

VOL. QTY.

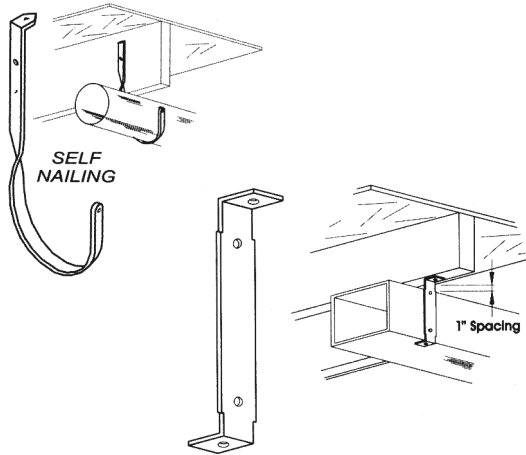

ROUND PIPE HANGER

R513700	BH-2	Hanger for round 5", 6" pipe run just below the joist. 18 Ga. Galvanized Steel	50	300
---------	------	---	----	-----

SQUARE DUCT HANGER

R513710	BH-8	8" Square Duct Hanger	100	500
R513720	BH-9	9" Square Duct Hanger	100	500
R513730	BH-10	10" Square Duct Hanger	100	500
R513740	BH-11	11" Square Duct Hanger	100	500
R513750	BH-12	12" Square Duct Hanger	100	500

BASSET PIPE SUPPORTS (For use with 16" stud centers)

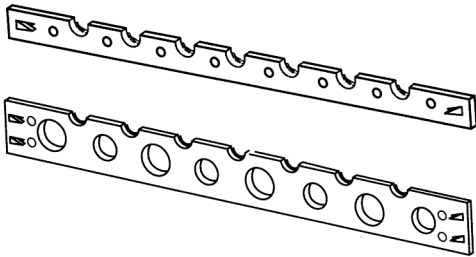

R514000	PS-1	Holds 1/2" tubing on 2" center, use with wood or metal studs.	50	500
R514100	PS-2	Multi-holed support for 1/2", 3/4" & 1" tubing on single support. Use with wood or metal studs 1/2" snap in on 2" centers 3/4" & 1" holes on 4" centers.	50	500

FLEX-DUCT SUPPORT WEBBING

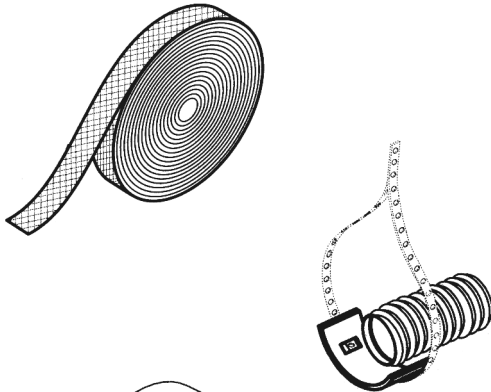

R514105	FSW-1-5	1 3/4" x 300' Black	24	48
R514110	FSW-3-5	3" x 300' Black	8	16

FLEX-DUCT SADDLE

R514120	FDS-9	30 ga. Galvanized Steel 9" x4"	25	250
R514125	FDS-12	30 ga. Galvanized Steel 12" x 4"	25	250

BANDING 1" WIDE 30 GA.

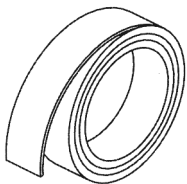

R514130		1" x 10' Roll 30 ga. Black	10	50
R514132		1" x 10' Roll 30 ga. Galvanized	10	50
R514136		1" x 100' Roll 30 ga. Black	1	10
R514138		1" x 100' Roll 30 ga. Galvanized	1	10

DRYER VENT KIT

CAT. NO.

LENGTH

SIZE

BOX QTY.

VOL. QTY.



DRYER VENT KIT

(Hose and clamps only)

R514400	5 FT.	4"	10	20
R514500	8 FT.	4"	10	20

(VENT HOOD NOT INCLUDED)

CUTTERS AND BITS

CAT. NO.	MFG. NO.	DESCRIPTION	BOX QTY.	VOL. QTY.
----------	----------	-------------	----------	-----------

“SOCKET SAVERS”

- Removes Schedule 40 plastic pipe
- Cuts ABS or PVC DWV pipe below slab
- Fits 1/2" variable speed power drill

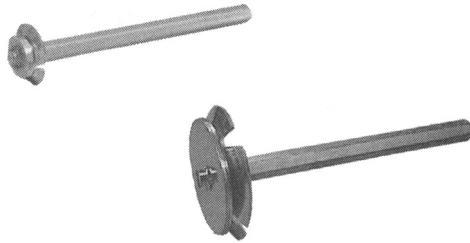

R515000	J44-050	1/2" Socket Saver	1	6*
R515100	J44-075	3/4" Socket Saver	1	6*
R515200	J44-100	1" Socket Saver	1	6*
R515400	J44-150	1 1/2" Socket Saver	1	6*
R515500	J44-200	2" Socket Saver	1	6*
R515600	J44-300	3" Socket Saver	1	6*
R515700	J44-400	4" Socket Saver	1	6*

*May Be Assorted For Volume Quantity.

“RAM BIT”

FOR ABS, PWV, PVC, DWV RIGID PVC ELECTRIC CONDUIT

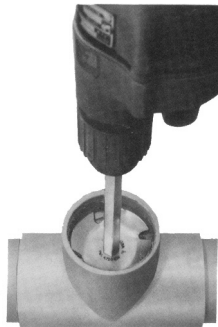

R517000		1/2" Ram Bit	1	6*
R517100		3/4" Ram Bit	1	6*
R517200		1" Ram Bit	1	6*
R517300		1 1/4" Ram Bit	1	6*
R517400		1 1/2" Ram Bit	1	6*
R517500		2" Ram Bit	1	6*
R517600		3" Ram Bit	1	6*
R517700		4" Ram Bit	1	6*

*May Be Assorted For Volume Quantity.

SELF FEED WOOD BORING BITS



R525000	05101	1" 25MM	1	6*
R525100	05102	1 1/8" 29MM	1	6*
R525200	05103	1 1/4" 32MM	1	6*
R525300	05104	1 3/8" 35MM	1	6*
R525400	05105	1 1/2" 38MM	1	6*
R525500	05106	1 3/4" 44MM	1	6*
R525600	05201	2" 51MM	1	6*
R525700	05202	2 1/8" 54MM	1	6*
R525800	05205	2 1/4" 57MM	1	6*
R525900	05206	2 9/16" 65MM	1	6*
R526000	05301	3" 76MM	1	6*
R526100	05302	3 5/8" 92MM	1	6*
R526200	05303	4 5/8" 117MM	1	6*
R526300	05304	5 1/2" Extension	1	6*
R526310	05309	Lead Screws for 1" to 2 9/16" (3 per pack)	1	6*
R526320	05310	Set Screws for 1" to 2 9/16" (5 per pack)	1	6*
R526330	05308	Lead Screws for 3" to 4 5/8" (3 per pack)	1	6*
R526340	05313	Set Screws for 3" to 4 5/8" (5 per pack)	1	6*

KITS

R526350	05015	Kit (1 3/8", 1 1/2", 2 1/8", 2 9/16")	1	6*
R526360	05013	Kit (1", 1 1/8", 1 1/4", 1 3/8", 1 1/2", 1 3/4", 2 1/8", 2 9/16", 5 1/2" Extension)	1	6*

*May Be Assorted For Volume Quantity.

RICHARD SPECIALTY CO., INC.

FLEXIBLE CONNECTORS

CAT. NO.

DESCRIPTION

BOX QTY. VOL. QTY.

STAINLESS STEEL CONNECTOR

LAVATORY HOOK UPS



R541000	1/2" FIP x 1/2" FIP x 12"	1	12
R541100	1/2" FIP x 1/2" FIP x 20"	1	12
R541200	1/2" FIP x 1/2" FIP x 30"	1	12



R541700	3/8" O.D. x 3/8" O.D. x 12"	1	12
R541710	3/8" O.D. x 3/8" O.D. x 20"	1	12



R542000	1/2" FIP x 3/8" O.D. Comp nut x 12"	1	12
R542010	1/2" FIP x 3/8" O.D. Comp nut x 16"	1	12
R542100	1/2" FIP x 3/8" O.D. Comp nut x 20"	1	12
R542200	1/2" FIP x 3/8" O.D. Comp nut x 30"	1	12



R542500	1/2" FIP x 1/2" O.D. Comp nut x 12"	1	12
R542510	1/2" FIP x 1/2" O.D. Comp nut x 16"	1	12
R542600	1/2" FIP x 1/2" O.D. Comp nut x 20"	1	12
R542700	1/2" FIP x 1/2" O.D. Comp nut x 30"	1	12

CLOSET HOOK UPS



R542900	3/8" O.D. Comp nut x ballcock x 6"	1	12
R543000	3/8" O.D. Comp nut x ballcock x 9"	1	12
R543100	3/8" O.D. Comp nut x ballcock x 12"	1	12
R543110	3/8" O.D. Comp nut x ballcock x 16"	1	12
R543200	3/8" O.D. Comp nut x ballcock x 20"	1	12



R543400	1/2" O.D. Comp nut x ballcock x 6"	1	12
R543500	1/2" O.D. Comp nut x ballcock x 9"	1	12
R543600	1/2" O.D. Comp nut x ballcock x 12"	1	12
R543700	1/2" O.D. Comp nut x ballcock x 20"	1	12



R543710-R543714

WASHING MACHINE CONNECTORS

R543710	3/4" FHT x 3/4" FHT x 48"	1	12
R543712	3/4" FHT x 3/4" FHT x 60"	1	12
R543714	3/4" FHT x 3/4" FHT x 72"	1	12

R543720-R543724



DISHWASHER CONNECTORS

R543720	3/8" Fem Comp x 3/8" Fem Comp. x 48"	1	12
R543722	3/8" Fem Comp x 3/8" Fem Comp. x 60"	1	12
R543724	3/8" Fem Comp x 3/8" Fem Comp x 72"	1	12

ADJUSTABLE HOSE CLAMPS CAT. NO. CAT. NO. SIZE CLAMP DIAMETER MIN. CLAMP DIAMETER MAX. BOX QTY. VOL. QTY.

STAINLESS STEEL BAND & HOUSING (Continued)



ALL STAINLESS STEEL	PLATED SCREW & HOUSING						
R543900	R545000	#4	7/32"	5/8"	10	200*	
R544000	R545002	#6	7/16"	25/32"	10	200*	
R544100	R545004	#8	1/2"	29/32"	10	200*	
R544150	R545006	#10	9/16"	1 1/16"	10	200*	
R544200	R545008	#12	11/16"	1 1/4"	10	200*	
R544300	R545010	#16	13/16"	1 1/2"	10	200*	
R544400	R545012	#20	13/16"	1 3/4"	10	200*	
R544500	R545014	#24	1 1/16"	2"	10	200*	
R544600	R545016	#28	1 5/16"	2 1/4"	10	200*	
R544700	R545018	#32	1 9/16"	2 1/2"	10	200*	
R544800	R545020	#36	1 13/16"	2 3/4"	10	200*	
R544900	R545022	#40	2 1/16"	3"	10	200*	
R544905	R545024	#44	2 5/16"	3 1/4"	10	200*	
R544910	R545026	#48	2 9/16"	3 1/2"	10	200*	
R544915	R545028	#52	2 13/16"	3 3/4"	10	200*	
R544920	R545030	#56	3 1/16"	4"	10	200*	
R544925	R545032	#60	3 5/16"	4 1/4"	10	200*	
R544930	R545034	#64	3 9/16"	4 1/2"	10	200*	
R544940	R545038	#72	4 1/16"	5"	10	200*	
R544945	R545040	#80	4 5/8"	5 1/2"	10	200*	
R544950	R545042	#88	5 1/8"	6"	10	200*	
R544955	R545044	#96	5 5/8"	6 1/2"	10	200*	
R544960	R545046	#104	6 1/8"	7"	10	200*	
R544965	R545048	#128	6 1/8"	8 1/2"	10	200*	

*May Be Assorted For Volume Quantity.

BRASS CLOSET SPUDS CAT. NO. CAT. NO. SIZE BOX QTY. VOL. QTY.



WASHER ONLY

R546000	R546700	1" x 3/4"	1	12
R546100	R546705	1 1/4" x 3/4"	1	12
R546200	R546710	1 1/4" x 1 1/4"	1	12
R546300	R546715	1 1/2" x 1 1/2"	1	12
R546400	R546720	2" x 1 1/4"	1	12
R546500	R546725	2" x 1 1/2"	1	12
R546600	R546730	2" x 2"	1	12

BRASS CLOSET SPUD NUT WRENCHES CAT. NO. SIZE BOX QTY. VOL. QTY.

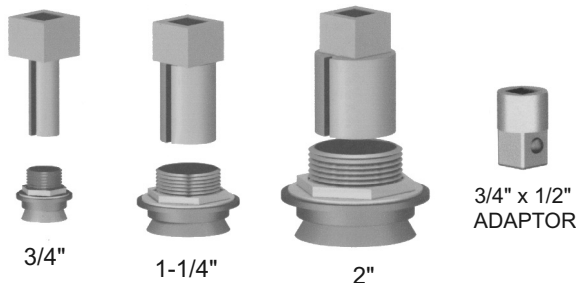

R546800	For 3/4" Spuds	1	6
R546805	For 1 1/4" Spuds	1	6
R546815	For 2" Spuds	1	6
R546825	3/4" x 1/2" Adaptor	1	2

NOTE - Tools can also be used on radiator nipples.

RICHARD SPECIALTY CO., INC.

BRASS PLUGS

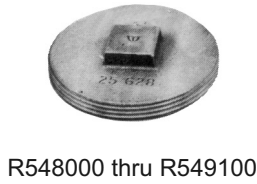

CAT. NO.
SOLID BRASS

CAT. NO.
SOLID BRASS

SIZE

BOX
QTY.

VOL.
QTY.

RAISED HEAD SOUTHERN PATTERN

R548000
R548100
R548200
R548300
R548400

COUNTERSUNK HEAD SOUTHERN PATTERN

R551000
R551100
R551200
R551300
R551400

1 1/2"
2"
2 1/2"
3"
3 1/2"

1 6
1 6
1 6
1 6
1 6

R548500
R548600
R548700
R548900
R549000
R549100

R551500
R551600
R551700
R551900
R552000
-

4"
4 1/2"
5"
6"
8"
10"

1 6
1 6
1 6
1 6
1 6
1 6

PLASTIC PLUGS

CAT.
NO.

CAT.
NO.

SIZE

BOX
QTY.

VOL.
QTY.

PLASTIC PLUGS - PVC

RAISED HEAD

R552200
R552205
R552210
R552215
R552220
R552225
R552235

COUNTERSUNK HEAD

R552300
R552305
R552310
R552315
R552320
R552325
R552335

1 1/2"
2"
2 1/2"
3"
3 1/2"
4"
6"

1 20*
1 20*
1 20*
1 20*
1 20*
1 20*
1 20*

*May Be Assorted For Volume Quantity.

COUNTERSUNK PLUGS WITH THREADED BRASS INSERT

R552500
R552505
R552510
R552515
R552520
R552525

1 1/2"
2"
2 1/2"
3"
3 1/2"
4"

1 20*
1 20*
1 20*
1 20*
1 20*
1 20*

*May Be Assorted For Volume Quantity.

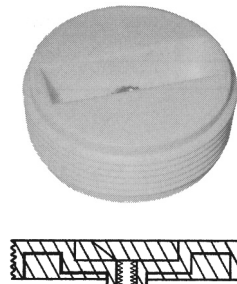
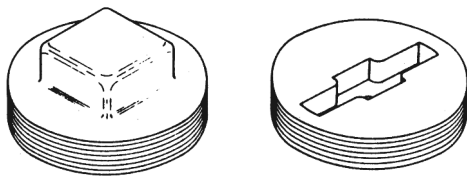

THREADED BRASS INSERT

ACCESS PANEL

CAT.
NO.

CAT.
NO.

SIZE

BOX
QTY.

VOL.
QTY.

PLASTIC ACCESS PANEL

R552540
R552545
R552550
R552555
R552560
R552610
R552620

AP-46
AP-69
AP-88
AP-1414
AP-1429

4" x 6"
6" x 9"
8" x 8"
14" x 14"
14" x 29"
6" x 9"
14" x 14"

1 12
1 12
1 6
1 6
1 6
1 10
1 10

PLASTIC ACCESS COVER

R552650

12" x 12"

1 20

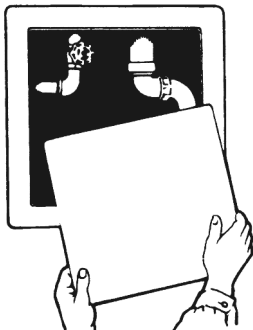

NUTS		CAT. NO.	DESCRIPTION	BOX QTY.	VOL. QTY.
-------------	--	----------	-------------	----------	-----------

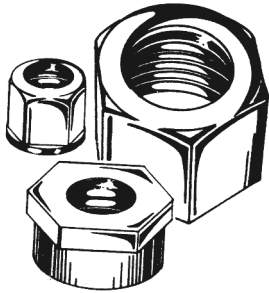

COUPLING NUTS

R554000	1/2" x 3/8"-14	Plain Finish	25	100
R554100	1/2" x 7/16"-14	Plain Finish	25	100
R554200	1/2" x 1/2"-14	Brass Finish	25	100
R554210	1/2" x 1/2"-14	Chrome	25	100
R554300	Ballcock Coupling nut 11/16" hole brass		25	100
R554400	Ballcock Coupling nut 1/2" hole brass		25	100
R554410	3/4" x 1/2"-14	Chrome	25	100
R554425	3/4" x 3/4"-14	Chrome	25	100

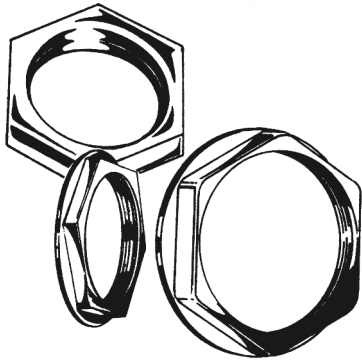

LOCK NUTS

R555000	1/2"-14 Hex	Plain	25	100
R555100	1/2"-14 Flange	Plain	25	100
R555120	5/8"-18 LH Thread (Tank lever)		25	100
R555200	3/4"-14 Hex	Plain	25	100
R555300	3/4"-14 Flange	Plain	25	100
R555400	15/16"-14 Ballcock	Plain	25	100
R555500	1"-11 1/2	Plain	25	100
R555600	1 1/4"-11 1/2	Plain	25	100
R555800	1 1/2"-11 1/2	Plain	25	100
R555900	2"-11 1/2	Plain	25	100
R556000	3 3/8"-14	Plain	25	100

HANDLES		CAT. NO.	SIZE	DESCRIPTION	BOX QTY.	VOL. QTY.
----------------	--	----------	------	-------------	----------	-----------

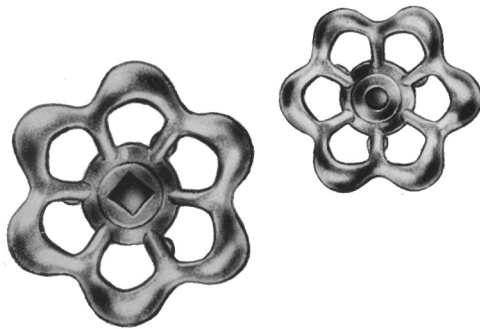

VALVE WHEEL HANDLES

R557000	2"	.300 Square w/.220 round hole plain	25	100
R557200	2"	.300 Dia. x 12 pt. spline w/.220 round hole red	25	100
R557300	2"	.415 Dia. x 16 pt. spline w/.220 round hole red	25	100
R557900	2 1/8"	.310 Square w/.25 round hole burnished	25	100
R558300	2 5/16"	.257 Square red	25	100



T-HANDLES

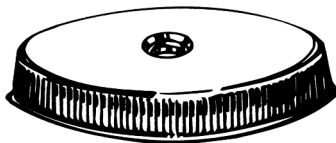

R558500	12 Point spline	25	100
R558510	16 Point spline	25	100





OVAL HANDLES

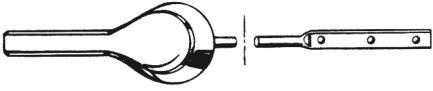

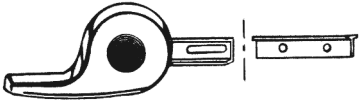
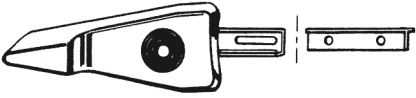
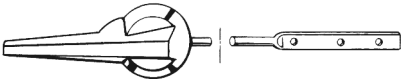
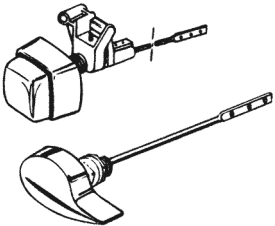
R558520	18 Point spline	25	100
---------	-----------------	----	-----

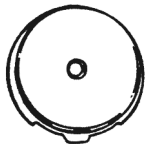

RICHARD SPECIALTY CO., INC.

TANK LEVER ASSEMBLIES		CAT. NO.	MFG. NO.	DESCRIPTION	BOX QTY.	VOL. QTY.
TANK LEVER ASSEMBLIES						
	R559000	Model 27	Brass Arm Plastic Parts-Polished Brass	1	12	
	R559100	Model 27	Brass Arm Zinc Parts-Buffered Chrome	1	12	
	R559200	Model 27	Brass Arm Plastic Parts-Buffered Chrome	1	12	
	R559300	Model 27	4 1/2" Brass Arm Plastic Parts-Buffered Chrome	1	12	
	R559500	Model 55	Brass Arm Zinc Part-Burnished Chrome	1	12	
	R559600	Model 55	Brass Arm Plastic Parts-Burnished Chrome	1	12	
	R559700	Model 55	Fortalloy Arm Zinc Parts-Burnished Chrome	1	12	
	R559800	Model 55	Fortalloy Arm Plastic Parts-Burnished Chrome	1	12	
	R559810	Model 60	All Plastic Tank Lever-Chrome	1	12	
	R559815	Model 60	All Plastic Tank Lever-White	1	12	
	R559820	Model 60	All Plastic Tank Lever-Bone	1	12	
	R559830	Model 70	All Plastic Tank Lever-Chrome	1	12	
	R559835	Model 70	All Plastic Tank Lever-White	1	12	
	R559840	Model 70	All Plastic Tank Lever-Bone	1	12	
	R559850	Model 81	Brass Arm Zinc Parts-Chrome	1	12	
	R559855	Model 81	5 1/2" Brass Arm Plastic Parts-Chrome	1	12	
	R559910		End Mount Pushbutton-Buffered Chrome	1	12	
	R559940		End Mount Brass Arm Plastic Nut-Buffered Chrome	1	12	

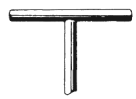
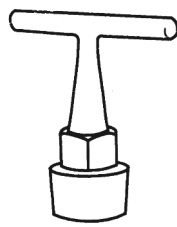
OVERFLOW FACEPLATES		CAT. NO.	MFG. NO.	DESCRIPTION	BOX QTY.	VOL. QTY.
----------------------------	--	----------	----------	-------------	----------	-----------

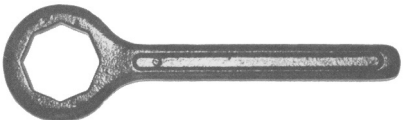
OVERFLOW FACEPLATES & ASSEMBLIES (Buffered Chrome)						
		R561000	#65	Round Overflow Faceplate assembly w/spring	1	12
R561000	R561100	R561100	#67	Recessed Overflow Faceplate assembly w/spring	1	12
		R561200	#69	Round Overflow w/o center hole	1	12
R561200	R561300	R561300	#61	Round Overflow Faceplate w/single center hole	1	12

KEYS		CAT. NO.	DESCRIPTION	BOX QTY.	VOL. QTY.
KEYS					
	R562000	Air Valve-Brite Plate	25	100	
	R562500	Sillcock Key .255 Square 1/4"	25	100	
	R562600	Sillcock Key .325 Square 5/16"	25	100	
	R562700	Sillcock Key .270 Square	25	100	
STREET KEYS - WATER METER KEYS					
	R563000	1/2" x 36"	1	6	
	R563100	5/8" x 36"	1	6	
	R563200	5/8" x 60"	1	6	
	R563300	3/4" x 36"	1	6	
	R563400	3/4" x 60"	1	6	
	R563500	5/8" x 84"	1	6	
	R563600	Pentagon Key - Import	1	6	
	R563605	Pentagon Key - USA	1	6	
HYDRANT WRENCHES					
	R563700	Hydrant Wrench-Heavy Duty (Cadmium Plated)	1	6	
	R563750	2 3/4" Fire Hydrant Top Valve Seat Removal Wrench	1	6	

TUB SPOUTS		CAT. NO.	MATERIAL	FINISH	BOX QTY.	VOL. QTY.	
TUB FILLER With 1/2" IPS connection at nose end of spout							
	R565200	Brass	Chrome	1	6		
	R565215	Die Cast	Chrome	1	6		
	R565225	Die Cast	Polished Brass	1	6		
TUB FILLER With 1/2" or 3/4" IPS connection at nose end of spout with bushing included							
	R565230	Die Cast	Chrome	1	6		
SLIDE Connects to 1/2" CWT at wall end of spout							
	R565242	Die Cast	Chrome	1	6		
DIVERTER SPOUTS-BACK LIFT							
Connects to 1/2" IPS at wall end of spout							
	R565250	Brass	Chrome	1	6		
	Connects to 3/4" IPS at wall end of spout						
	R565255	Brass	Chrome	1	6		
Connects to 1/2" or 3/4" IPS at wall end of spout with bushing included.							
	R565260	Brass	Chrome	1	6		
	R565280	Die Cast	Chrome	1	6		
	R565290	Die Cast	Polished Brass	1	6		

R565200 - 565242

R565250 - 565290

RICHARD SPECIALTY CO., INC.

TUB SPOUTS

CAT. NO.	MFG. NO.	DESCRIPTION MATERIAL	FINISH	BOX QTY.	VOL. QTY.
----------	----------	----------------------	--------	----------	-----------

DIVERTER SPOUTS FRONT LIFT

Connects to 1/2" IPS at nose end of spout

R565300		Brass	Chrome	1	6
R565305		Brass	Polished Brass	1	6

Connects to 1/2" or 3/4" with fitting

R565310		Die Cast	Chrome	1	6
R565320		Die Cast	Polished Brass	1	6

Connects to 1/2" CWT at wall end of spout

R565340		Die Cast	Chrome	1	6
R565350		Die Cast	Polished Brass	1	6



REDUCING BUSHINGS

R565400		3/4" x 1/2" Reducing Bushing-Brass		25	-
R565410		3/4" x 1/2" Reducing Bushing-Celcon		25	-

TWIN ELL

R565500	257-27-OM	Twin Ell. Provides a 3/4" thread for the tub and 1/2" thread for the shower.		1	6
---------	-----------	--	--	---	---



DIVERTER SPOUTS WITH ADAPTERS FOR HANDSHOWER ATTACHMENTS

1/2" IPS Top Brass adapter swivel nut-spout connects at wall end with 1/2" or 3/4" IPS with celcon bushing.

R565600		Die Cast	Chrome	1	6
---------	--	----------	--------	---	---



3/8" IPS TOP BRASS ADAPTER SWIVEL NUT

Spout connects at wall end with 1/2" or 3/4" IPS with celcon bushing.

R565610		Die Cast	Chrome	1	6
---------	--	----------	--------	---	---



1/2" IPS SIDE ELBOW ADAPTER

Spout connects at wall end with 1/2" or 3/4" IPS with celcon bushing.

R565620		Die Cast	Chrome	1	6
---------	--	----------	--------	---	---



1/2" IPS BOTTOM ADAPTER (ABS)

Spout connects at wall end with 1/2" or 3/4" IPS with celcon bushing.

R565630		Die Cast	Chrome	1	6
R565640		Die Cast	Polished Brass	1	6

TUB SPOUTS



GARDENWALL™ CAST BRASS BATH TUB FILLER

Spout connects to 1/2" IPS at nose end of spout. Overall length 8 1/2".

CAT. NO.	DESCRIPTION	BOX QTY.	VOL. QTY.
R565645	Polished Chrome	1	6
R565650	Brassy Gold™	1	6
R565652	Satin Nickel	1	6

GARDENWALL™ CAST BRASS BATH DIVERTER

Spout connects to 1/2" IPS at nose end of spout. Overall length 8 1/2".

CAT. NO.	DESCRIPTION	BOX QTY.	VOL. QTY.
R565655	Polished Chrome	1	6
R565660	Brassy Gold™	1	6
R565665	Satin Nickel	1	6

LEDGE FAUCETS

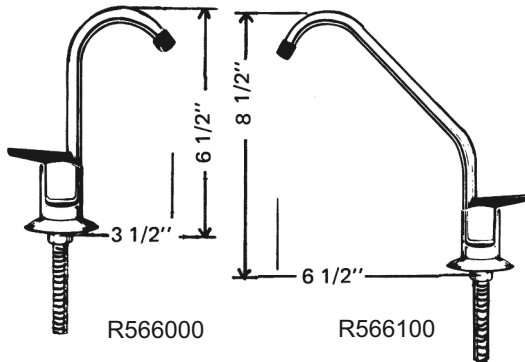

LEDGE FAUCETS

CAT. NO.	MFG. NO.	DESCRIPTION	BOX QTY.	VOL. QTY.
R566000	SS-484	All brass body and spout. Chrome over nickel plating. Full swivel spout.	1	6
R566100	LR-484	Same as above only w/long spout.	1	6

BRASS DIVERTER VALVES



R566500	BD100	Barbed outlet port. For use with 3/16" I.D. hose. Barb dim. .312 O.D. and .109 I.D.	1	6
R566600	BD200	Threaded outlet port. Threads are 5/16" x 24, use with 1/8" sleeve and comp. nut. Hose size 1/7" O.D.	1	6
R566700	BD400	Barbed outlet port. Use with 1/8" I.D. hose. Barb dim. .200 O.D. and .109 I.D.	1	6
R566800	BD500	Threaded outlet port. Threads are 1/8" straight pipe threads. Barb I.D. is .140	1	6
R566900	BD600	Threaded outlet port. Threads are 7/16" x 24, for use with 1/4" sleeve and comp. nut. Hose 1/4" O.D.	1	6
R567000	BD800	Diverter with dispensing spout. Top port is feed line to water filter 1/8" I.D. hose. Filtered water returns to bottom spout and is dispensed.	1	6
R567100	BD1100	Twin barbed ports. 1/8" I.D. hose. Top port is feed line to filter. Bottom port combination barb and brine valve.	1	6
R567200	BD1200	Triple barbed ports. Top port is feed line to filter. Middle port is overflow line from reservoir. Bottom port is combination port and brine valve.	1	6

*R566500 With Revolving Collar

* Revolving Collar available with any of above diverters. Inside threads have 55/64" x 27. Must be ordered special.

RICHARD SPECIALTY CO., INC.

STUD GUARDS

CAT. NO.	GAUGE	LENGTH/WIDTH	BOX QTY.	VOL. QTY.
----------	-------	--------------	----------	-----------

STYLE 501 (100 Per Ctn.)

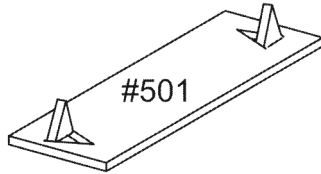

R568000	20 Gauge	3" x 1 1/2"	1 ctn.	50 ctn*
R568100	20 Gauge	5" x 1 1/2"	1 ctn.	50 ctn*
R568200	20 Gauge	6" x 1 1/2"	1 ctn.	50 ctn*
R568300	18 Gauge	3" x 1 1/2"	1 ctn.	50 ctn*
R568400	18 Gauge	5" x 1 1/2"	1 ctn.	50 ctn*
R568500	18 Gauge	6" x 1 1/2"	1 ctn.	50 ctn*
R568600	16 Gauge	3" x 1 1/2"	1 ctn.	50 ctn*
R568700	16 Gauge	5" x 1 1/2"	1 ctn.	50 ctn*
R568800	16 Gauge	6" x 1 1/2"	1 ctn.	50 ctn*

STYLE 503 (100 Per Ctn.)

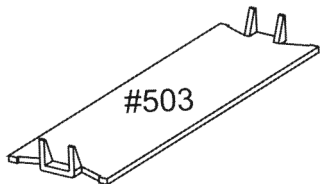

R570000	20 Gauge	3" x 1 1/2"	1 ctn.	50 ctn*
R570010	20 Gauge	4" x 1 1/2"	1 ctn.	50 ctn*
R570100	20 Gauge	5" x 1 1/2"	1 ctn.	50 ctn*
R570200	20 Gauge	6" x 1 1/2"	1 ctn.	50 ctn*
R570205	20 Gauge	8" x 1 1/2" **	1 ctn.	50 ctn*
R570210	20 Gauge	12" x 1 1/2" **	1 ctn.	50 ctn*
R570215	20 Gauge	18" x 1 1/2" **	1 ctn.	50 ctn*
R570220	20 Gauge	24" x 1 1/2" **	1 ctn.	50 ctn*
R570300	18 Gauge	3" x 1 1/2"	1 ctn.	50 ctn*
R570400	18 Gauge	5" x 1 1/2"	1 ctn.	50 ctn*
R570500	18 Gauge	6" x 1 1/2"	1 ctn.	50 ctn*
R570505	18 Gauge	8" x 1 1/2" **	1 ctn.	50 ctn*
R570510	18 Gauge	12" x 1 1/2" **	1 ctn.	50 ctn*
R570515	18 Gauge	18" x 1 1/2" **	1 ctn.	50 ctn*
R570520	18 Gauge	24" x 1 1/2" **	1 ctn.	50 ctn*
R570600	16 Gauge	3" x 1 1/2"	1 ctn.	50 ctn*
R570700	16 Gauge	5" x 1 1/2"	1 ctn.	50 ctn*
R570800	16 Gauge	6" x 1 1/2"	1 ctn.	50 ctn*

STYLE 504 Use With Steel Studs (100 Per Ctn.)

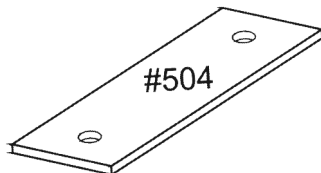

R570802	20 Gauge	3" x 1 1/2"	1 ctn.	50 ctn*
R570804	20 Gauge	5" x 1 1/2"	1 ctn.	50 ctn*
R570806	20 Gauge	6" x 1 1/2"	1 ctn.	50 ctn*
R570810	18 Gauge	3" x 1 1/2"	1 ctn.	50 ctn*
R570812	18 Gauge	5" x 1 1/2"	1 ctn.	50 ctn*
R570814	18 Gauge	6" x 1 1/2"	1 ctn.	50 ctn*
R570820	16 Gauge	3" x 1 1/2"	1 ctn.	50 ctn*
R570822	16 Gauge	5" x 1 1/2"	1 ctn.	50 ctn*
R570824	16 Gauge	6" x 1 1/2"	1 ctn.	50 ctn*

STUDGUARDS 2" & 3" WIDE (100 Per Ctn.)

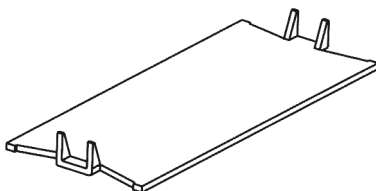

R570850	18 Gauge	2" x 5"	1 ctn.	50 ctn*
R570852	18 Gauge	2" x 6"	1 ctn.	50 ctn*
R570854	18 Gauge	3" x 3"	1 ctn.	50 ctn*
R570856	18 Gauge	3" x 5"	1 ctn.	50 ctn*
R570858	18 Gauge	3" x 6"	1 ctn.	50 ctn*

*May Be Assorted For Volume Quantity.

**50 Per Ctn.

STUD GUARDS

SINGLE STUD SUPPORT DOUBLE STUD SUPPORT TRIPLE STUD SUPPORT

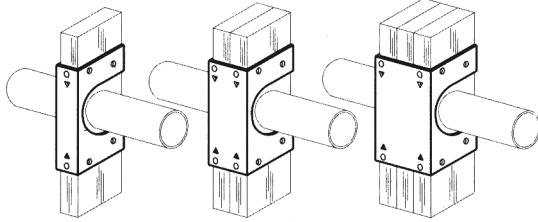

1.51" WIDE 3.1" WIDE 4.6" WIDE

STUD SUPPORTS - 18 GA. GALVANIZED STEEL

CAT. NO.	GAUGE	LENGTH/WIDTH	BOX QTY.	VOL. QTY.
R570910	BS-150-18	1.51" Wide	25	100
R570915	BS-300-18	3.1" Wide	25	100
R570920	BS-450-18	4.6" Wide	10	50

STUD SUPPORTS - 16 GA. GALVANIZED STEEL

CAT. NO.	GAUGE	LENGTH/WIDTH	BOX QTY.	VOL. QTY.
R570925	BS-150-16	1.51" Wide	25	100
R570930	BS-300-16	3.1" Wide	25	100
R570935	BS-450-16	4.6" Wide	10	50

FHA PLATE (50 Per Ctn.)

R571000	12 Gauge	9" x 1 1/2"	1 ctn.	20 ctn.
R571100	12 Gauge	12" x 1 1/2"	1 ctn.	20 ctn.
R571200	12 Gauge	18" x 1 1/2"	1 ctn.	20 ctn.
R571300	12 Gauge	24" x 1 1/2"	1 ctn.	20 ctn.
R571500	14 Gauge	9" x 1 1/2"	1 ctn.	20 ctn.
R571600	14 Gauge	12" x 1 1/2"	1 ctn.	20 ctn.
R571700	14 Gauge	18" x 1 1/2"	1 ctn.	20 ctn.
R571800	14 Gauge	24" x 1 1/2"	1 ctn.	20 ctn.
R572000	16 Gauge	9" x 1 1/2"	1 ctn.	20 ctn.
R572100	16 Gauge	12" x 1 1/2"	1 ctn.	20 ctn.
R572200	16 Gauge	18" x 1 1/2"	1 ctn.	20 ctn.
R572300	16 Gauge	24" x 1 1/2"	1 ctn.	20 ctn.
R572500	18 Gauge	9" x 1 1/2"	1 ctn.	20 ctn.
R572600	18 Gauge	12" x 1 1/2"	1 ctn.	20 ctn.
R572700	18 Gauge	18" x 1 1/2"	1 ctn.	20 ctn.
R572800	18 Gauge	24" x 1 1/2"	1 ctn.	20 ctn.
R572802	16 Gauge	18" x 1 1/2"	1 ctn.	20 ctn.
R572803	16 Gauge	24" x 1 1/2"	1 ctn.	20 ctn.

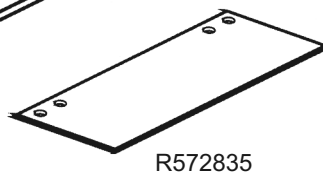
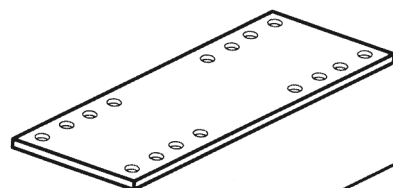
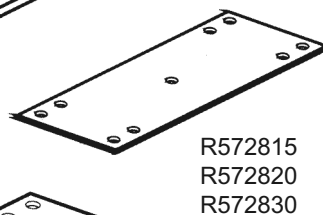
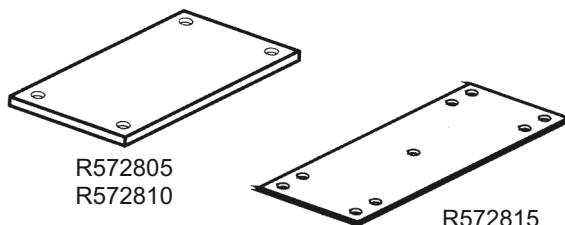
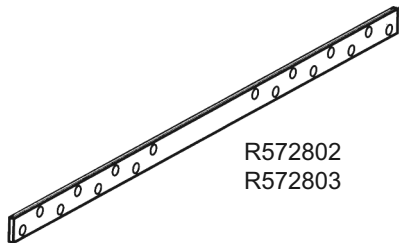
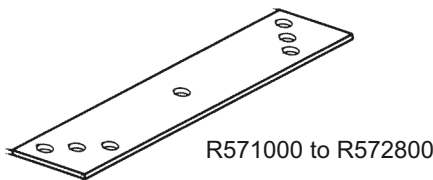

FHA PLATE - 300 3" Wide - 12-3 1/2" Wide (25 Per Ctn.)

R572805	300-612	12 Gauge	3" x 6"	1 ctn.	50 ctn.
R572810	300-912	12 Gauge	3" x 9"	1 ctn.	50 ctn.
R572815	300-1218	18 Gauge	3" x 12"	1 ctn.	50 ctn.
R572820	300-1816	16 Gauge	3" x 18"	1 ctn.	50 ctn.
R572825	300-1816-8	16 Gauge	3" x 18"	1 ctn.	50 ctn.
R572830	300-1818	18 Gauge	3" x 18"	1 ctn.	50 ctn.
R572835	312-1816	16 Gauge	3 1/2" x 18"	1 ctn.	50 ctn.

RICHARD SPECIALTY CO., INC.

FLAME SHIELDS

CAT.
NO.MFG.
NO.

DESCRIPTION/SIZE

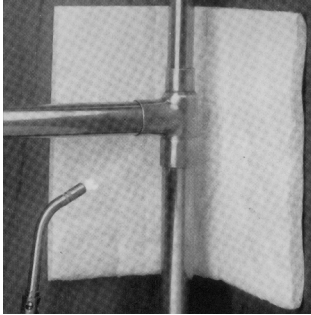
BOX VOL.
QTY. QTY.

FLAME GARD™

R574000		Flame Gard 9 1/2" x 12"	1	25
R574100		Flame Gard 24" x 24"	1	2
R574200		Flame Gard 24" x 50"	1	2

TORCH GUARD -

Heat resistance to 2,000° F.

R574300	71032	9" x 12"	1	10
R574305	71034	12" x 12"	1	10

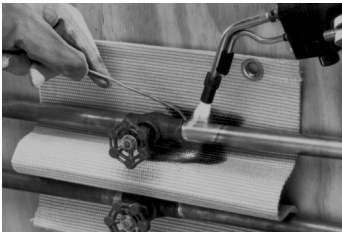

THE INSURANCE PAD™

Heat resistance to 2,500° F - Ideal for use with propane, mapp gas, acetylene/air & higher temperature torches.

R574320	71036	6" x 9"	1	10
R574325	71038	9" x 12"	1	10

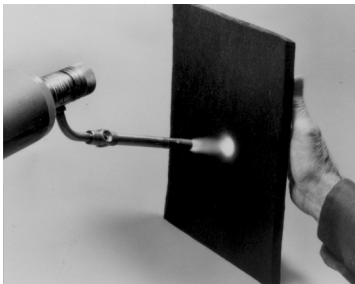

BLANKETS AND CURTAINS

R574330	72010	3' x 3' Blanket	1	2
R574335	72012	3' x 6' Blanket	1	2
R574340	72016	3' x 10' Blanket	1	2

PIPE FREEZING	CAT. NO.	DESCRIPTION	BOX QTY.	VOL. QTY.
---------------	-------------	-------------	-------------	--------------

ARCTIC FREEZE™ PORTABLE CO₂ PIPE FREEZING KIT

ARCTIC FREEZE™ portable CO₂ pipe freezing kit permits repairs and installation without draining the entire piping system. A temporary ice plug forms inside stopping the flow of liquid. Pipe freezing is safe, easy, non-flammable and non-toxic. ARCTIC FREEZE™ can freeze metal, copper, steel, iron, lead and plastic pipes. Liquids solidifying at 25°C (-13°F) such as water, brine, anti-freeze, organic solvents and some oils can be frozen.



R574500	#1 ARCTIC Unit Consisting of 2 - 1/4"-3/4" and 2 - 1"-2" jackets 2-8' high pressure hoses, 1-brass tee, 1-pr. gloves, 1-carrying bag & instruction sheets.	1	2
---------	---	---	---



R574800	#1 Jacket for 1/4" - 3/4"	1	2
R574900	#6 Jacket for 1" - 2"	1	2
R575000	#2 Jacket for 3/4" - 1 1/2"	1	2
R575050	#3 Jacket for 1 1/2" - 3"	1	2
R575052	#4 Jacket for 3" - 4"	1	2
R575055	#5 Jacket for 5" - 6"	1	2
R575060	Replacement Fill Orifice For Jacket	1	2

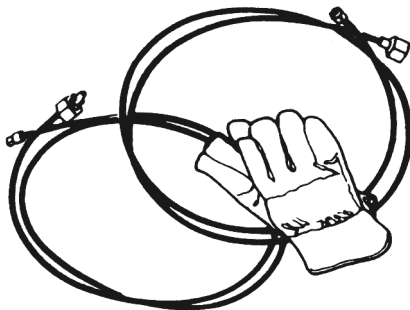

R575100	8' High Pressure Hose	1	2
---------	-----------------------	---	---

R575200	Brass Tee	1	2
---------	-----------	---	---



R575300	Gloves (Pair)	1	2
---------	---------------	---	---

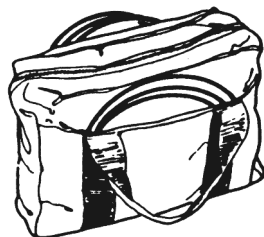

R575400	Carrying Bag	1	2
---------	--------------	---	---

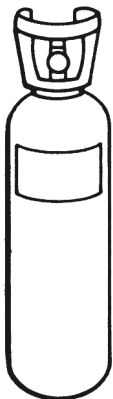

R575800	20 LB. Cylinder Empty	1	-
---------	-----------------------	---	---

R575900	20 LB. Cylinder Filled	1	-
---------	------------------------	---	---

R575950	50 LB. Cylinder Empty	1	-
---------	-----------------------	---	---

*For Hose and Jackets for ECONO FREEZE Please Call for Pricing.

RICHARD SPECIALTY CO., INC.

CAT. NO.	SIZE	LENGTH	I.D.	O.D.	MAXIMUM BURST PRESS.	BOX QTY.	VOL. QTY.
----------	------	--------	------	------	----------------------	----------	-----------

CLEAR VINYL TUBING

Nontoxic clear polyvinyl chloride (PVC).
Service temperature 150° F

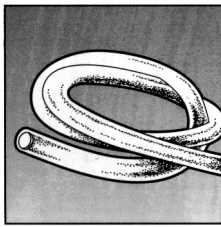

R576005	3/16"	100' Roll	.187	.267	37 PSI	1	2
R576010	1/4"	100' Roll	.250	.375	32 PSI	1	2
R576015	3/8"	100' Roll	.375	.500	27 PSI	1	2
R576020	1/2"	100' Roll	.500	.625	24 PSI	1	2
R576025	5/8"	100' Roll	.625	.750	21 PSI	1	2
R576030	3/4"	100' Roll	.750	.890	19 PSI	1	2
R576035	7/8"	50' Roll	.875	1.015	16 PSI	1	2

SOFT ALUMINUM TUBING 50' Coils

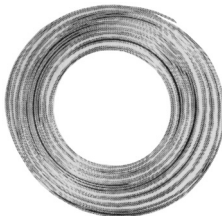

	O.D.	WALL		
R576042	1/8"	.025	1	2
R576044	3/16"	.028	1	2
R576046	1/4"	.032	1	2
R576048	5/16"	.035	1	2
R576050	3/8"	.035	1	2
R576052	7/16"	.035	1	2
R576054	1/2"	.035	1	2
R576056	5/8"	.035	1	2

WIRE CONNECTORS

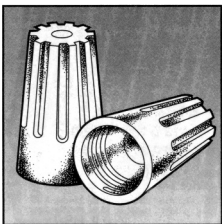

	UL DESCRIPTION	UL RATING	COLOR		
R576060	81-G	300 Volts	Grey	100	1000
R576065	82-B	300 Volts	Blue	100	1000
R576070	83-O	600 Volts	Orange	100	1000
R576075	84-Y	600 Volts	Yellow	100	1000
R576080	86-R	600 Volts	Red	100	1000

LONG BARREL™ WRENCH

Designed for tightening hex nuts on repair clamps, saddles and mechanical joint fittings. 6 point socket 1/2" square ratchet derive 6" long.

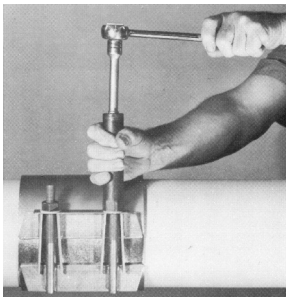

	MFG. NO.	SIZE	DESCRIPTION		
R576300	1516	15/16"	For 5/8" standard or stainless steel hex nuts.	1	6
R576310	1116	1 1/16"	For 5/8" heavy hex nuts used on most repair clamps.	1	6
R576320	1180	1 1/8"	For 3/4" standard or stainless steel hex nuts.	1	6
R576330	1140	1 1/4"	For 3/4" hex nuts used on most mechanical joint fittings.	1	6

GRAPHITE PACKING SPOOLS NON-ASBESTOS RECLOSABLE SPOOL



R580000	1/8" X 1/4 LB. Spool	1	6
R580100	1/4" X 1/4 LB. Spool	1	6

O-RING DONUT	CAT. NO.	DESCRIPTION	BOX QTY.	VOL. QTY.
---------------------	----------	-------------	----------	-----------



R580150	O-Ring Donut - to connect any 6" nominal bore to any 4" cast iron or plastic.	1	12
---------	---	---	----

SHOWERHEADS	CAT. NO.	DESCRIPTION	BOX QTY.	VOL. QTY.
--------------------	----------	-------------	----------	-----------

STANDARD FLOW SHOWERHEADS - ADJUSTABLE SPRAY

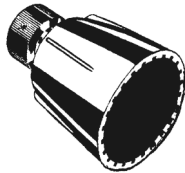

R580230	Fixed orifice showerhead - black face plate - brass ball connector.	1	6
R580235	Fixed orifice showerhead - black face plate - black ABS ball connector	1	6

Flow rate 2.5 GPM at 80 PSI, also 9.5 L/Min adjustable spray and pressure compensating flow control.

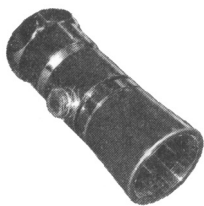

CHROME WITH SHUTOFF

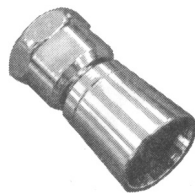

CHROME

WATER SAVER SHOWERHEAD

R580300	1" Chrome	1	6
R580305	1" Chrome with shutoff	1	6

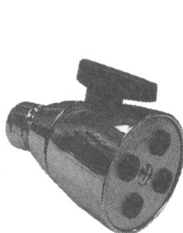

DIE CAST



PLASTIC

SHOWER HEADS (2.5 GPM Flowrate)

PLASTIC

R580310	2" Plastic - Chrome with plastic ball	1	6
R580315	2" White with plastic ball	1	6
R580320	2" Chrome with brass Ball	1	6

DIE CAST

R580325	2" Chrome - Adjustable	1	6
---------	------------------------	---	---

BRASS

R580330	1 3/4" Chrome - Adjustable	1	6
R580335	2 1/8" Chrome - Adjustable	1	6
R580340	3" Chrome - Adjustable	1	6



R580355



R580350







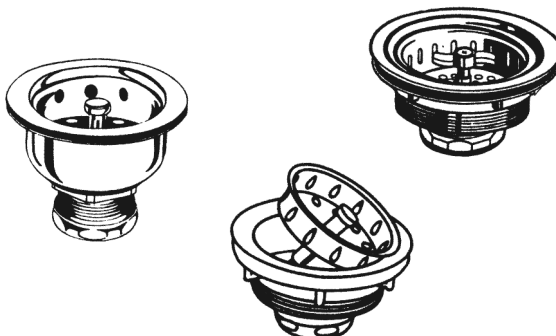

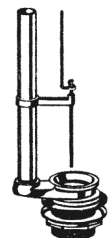

6-FUNCTION PULSATING SHOWERHEAD

R580350	Pulsating Showerhead Chrome plated	1	6
R580355	Pulsating Showerhead Plastic - Chrome - Plated	1	6

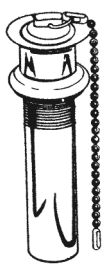
RICHARD SPECIALTY CO., INC.

BASKET STRAINERS		CAT. NO.	DESCRIPTION	BOX QTY.	VOL. QTY.
		R580400	Spin-in-cup	1	6
		R580410	Spin-in-cup with brass locknut and brass slipnut.	1	6
		R580420	Deep cup duo basket strainer	1	6
		R580430	Duo sink strainer with cup post	1	6
		R580440	Stainless Steel	1	6

BRASS DOUGLAS FLUSH VALVE		CAT. NO.	DESCRIPTION	BOX QTY.	VOL. QTY.
		R580500	Douglas flush valve with upper and lower brass lift wire.	1	6

SINK DRAINS		CAT. NO.	MFG. NO.	DESCRIPTION	BOX QTY.	VOL. QTY.
		R580502	10285-600CLS	Stainless steel top, plastic body, clicker pop-up	1	12
		R580503	10286-600CL-13	Spacer mounting kit for 600CLS	1	6
		R580504	10286-600CL-11	Replacement center grid, stainless steel	1	6
		R580505	10282-7800	Stainless steel clicker pop-up, 6" tail piece, with overflow holes	1	12
		R580510	10284-7840	Stainless steel clicker pop-up, 6" tail piece, without overflow holes	1	12
		R580520		1-1/4" Chrome plated cast brass with chain and stopper, 6" length	1	12
		R580530		1-1/4" Chrome plated cast brass with chain and stopper, 8" length	1	12
		R580540	10283-789	Stainless steel grid drain with removable center grid, with overflow	1	12
		R580542	10295-7849	Stainless steel grid drain with removable center grid, without overflow	1	12
		R580544	10288-6409	Brass chrome plated grid drain with removable center grid, with overflow	1	12
		R580546	10289-6409-1	Replacement center grid for 6409, brass chrome plated	1	6

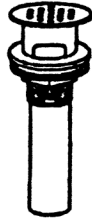
P.O. PLUGS	CAT. NO.	SIZE	DESCRIPTION	BOX QTY.	VOL. QTY.
	GRID TYPE - PLATED CAST BRASS				
	R580550	1 1/4"	6"	1	12
	R580555	1 1/4"	8"	1	12

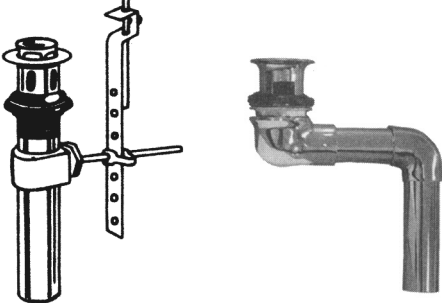
LAVATORY DRAINS	CAT. NO.	DESCRIPTION	BOX QTY.	VOL. QTY.
	LAVATORY DRAINS (POP-UP ASSEMBLY)			
	R580570	Chrome plated brass	1	12
	R580575	Chrome plated plastic	1	12
	R580580	Polished brass	1	12
HANDICAP LAVATORY DRAIN				
	R580590	1 1/4" Cast brass - Grid type	1	12

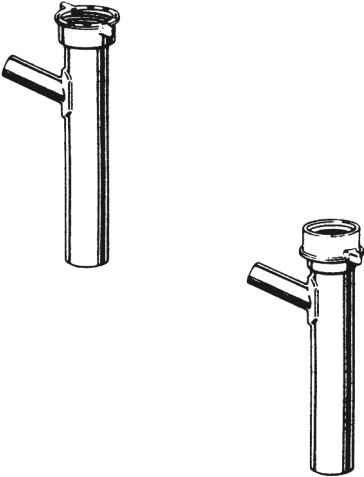
DISHWASHER BRANCH	CAT. NO.	DESCRIPTION	BOX QTY.	VOL. QTY.	
	PVC - WHITE POLYPROPYLENE				
	With wing nut only - direct connection				
	R580600	1 1/2" x 8" with 1/2" spout & washer	25	100	
	R580605	1 1/2" x 8" with 3/4" spout & washer	25	100	
	ABS - BLACK				
	R580610	1 1/2" x 8" with 1/2" spout & washer	25	100	
	R580615	1 1/2" x 8" with 3/4" spout & washer	25	100	
	PVC - WHITE POLYPROPYLENE - SLIP JOINT				
	R580630	1 1/2" x 8" with 1/2" spout, nut & washer	25	100	
	R580635	1 1/2" x 8" with 3/4" spout, nut & washer	25	100	
	ABS - BLACK				
	R580640	1 1/2" x 8" with 1/2" spout, nut & washer	25	100	
R580645	1 1/2" x 8" with 3/4" spout, nut & washer	25	100		

AIR GAP	CAT. NO.	MFG. NO.	DESCRIPTION	BOX QTY.	VOL. QTY.
	WHITE POLYPRO BODY				
	Chrome plated ABS cap				
	Protects dishwashers from sewage backflow by breaking the siphoning action in the drain line.				
	R580680	8126	Air Gap	50	100

RICHARD SPECIALTY CO., INC.

SLOAN "SPUD BUDDY"



CAT. NO.	DESCRIPTION	BOX QTY.	VOL. QTY.
	FLUSHOMETER SPUD WRENCH Sloan tailpiece tool-import		
R580805	Used to adjust or remove Flushometer tailpieces during rough-in or replacement. Fits H-551-A	25	100

RADIATOR HANDLES

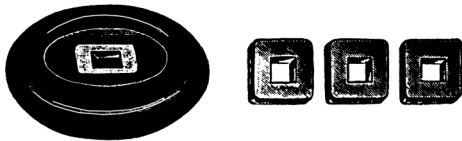

CAT. NO.	DESCRIPTION	BOX QTY.	VOL. QTY.
R580900	Three lug radiator handle	1	12

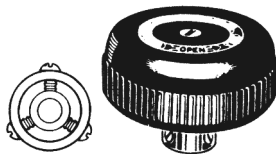

R580905	Three screw radiator handle	1	12
---------	-----------------------------	---	----



R580910	4 in 1 radiator handle	1	12
---------	------------------------	---	----

HOT TAPPER

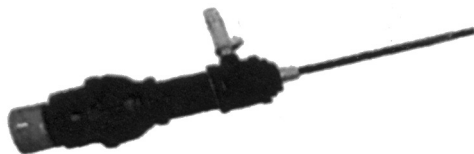

CAT. NO.	SIZE	BOX QTY.	VOL. QTY.
R581000	1/2" Hot Tapper	1	2
R581005	3/4" Hot Tapper	1	2
R581010	1" Hot Tapper	1	2
R581015	1 1/4" Hot Tapper	1	2
R581020	1 1/2" Hot Tapper	1	2
R581025	2" Hot Tapper	1	2
R581030	2 1/2" Hot Tapper	1	2
R581035	3" Hot Tapper	1	2
R581040	3 1/2" Hot Tapper	1	2
R581045	4" Hot Tapper	1	2
R581050	5" Hot Tapper	1	2
R581055	6" Hot Tapper	1	2

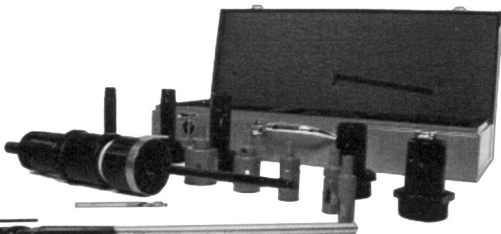

R581070	1/2" thru 2" Kit with case	1	2
R581080	1/2" thru 6" Kit with case	1	2

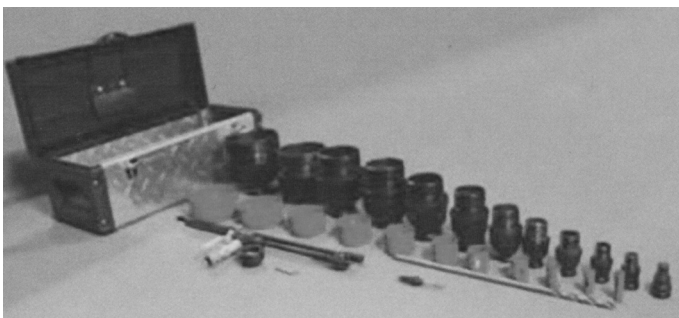

R581080

BAR GRATES	CAT. NO.	DESCRIPTION	BOX QTY.	VOL. QTY.
-------------------	----------	-------------	----------	-----------

CAST IRON BAR GRATES

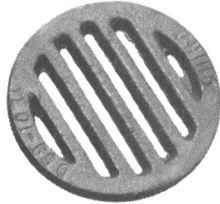

R581154	3" Cast Iron bar grates	1	25
R581158	4" Cast Iron bar grates	1	25
R581160	5" Cast Iron bar grates	1	25
R581162	6" Cast Iron bar grates	1	25
R581164	7" Cast Iron bar grates	1	25
R581166	8" Cast Iron bar grates	1	25

CAST IRON SOIL PIPE STRAINERS

R581180	2" Cast Iron soil pipe strainer (3" Dia.)	1	25
R581182	4" Cast Iron soil pipe strainer (4 3/4" Dia.)	1	25
R581184	5" Cast Iron soil pipe strainer (5 3/4" Dia.)	1	25
R581186	6" Cast Iron soil pipe strainer (6 3/4" Dia.)	1	25

CLOSET FLANGES	CAT. NO.	DESCRIPTION	BOX QTY.	VOL. QTY.
-----------------------	----------	-------------	----------	-----------

CAST IRON CLOSET FLANGES (Collar)

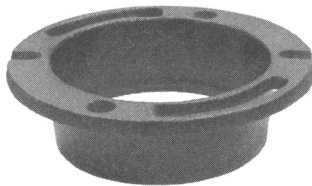

R582000	4" x 1" Closet collar	1	50
R582005	4" x 1 1/2" Closet collar	1	50
R582010	4" x 2" Closet collar	1	50
R582015	4" x 2 1/2" Closet collar	1	50
R582020	4" x 3" Closet collar	1	50
R582025	4" x 4" Closet collar	1	50
R582030	4" x 5" Closet collar	1	50
R582035	4" x 6" Closet collar	1	50
R582040	4" x 7" Closet collar	1	50
R582050	4" x 2" Offset closet collar	1	50

STAINLESS STEEL GRAB BARS- CONCEALED FLANGE	CAT. NO.	CAT. NO.	SIZE	BOX QTY.	VOL. QTY.
--	----------	----------	------	----------	-----------



	SATIN FINISH	PEENED FINISH			
R587200	R587300	1 1/4" x 12"	1	10	
R587202	R587302	1 1/4" x 16"	1	10	
R587204	R587304	1 1/4" x 18"	1	10	
R587206	R587306	1 1/4" x 24"	1	10	
R587209	R587308	1 1/4" x 30"	1	10	
R582210	R587310	1 1/4" x 32"	1	10	
R587212	R587312	1 1/4" x 36"	1	10	
R587214	R587314	1 1/4" x 42"	1	10	
R587216	R587316	1 1/4" x 48"	1	10	
R587218	R587318	1 1/2" x 12"	1	10	
R587220	R587320	1 1/2" x 16"	1	10	
R587222	R587322	1 1/2" x 18"	1	10	
R587224	R587324	1 1/2" x 24"	1	10	
R587226	R587326	1 1/2" x 30"	1	10	
R587228	R587328	1 1/2" x 32"	1	10	
R587230	R587330	1 1/2" x 36"	1	10	
R587232	R587332	1 1/2" x 42"	1	10	
R587234	R587334	1 1/2" x 48"	1	10	

RICHARD SPECIALTY CO., INC.

RB CLIP GUN SYSTEMS

CAT. NO.	MFG. NO.	DESCRIPTION/COLOR	BOX QTY.	VOL. QTY.
----------	----------	-------------------	----------	-----------

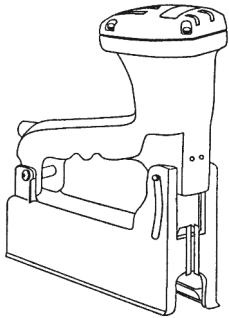

R587400

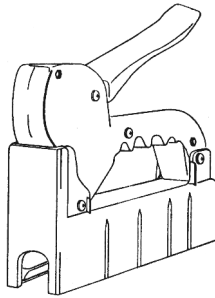

R587410

CLIP GUNS

R587400	RB-6	Pneumatic Clip Gun	1	2
R587410	RB-5	Manual Clip Gun	1	2

CLIPS-STAND OFF (100 Per Box)

R587415	P3BK	For I.D. 3/8" Black	1BX	10BX
R587420	P4BK	For I.D. 1/2" Black	1BX	10BX
R587425	P5BK	For I.D. 3/4" Black	1BX	10BX

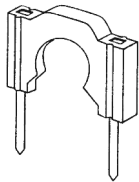

R587415-R587425

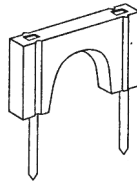

R587430-R587440

CLIPS-FLUSH MOUNT (100 Per Box)

R587430	F4OD	For 1/2" O.D. 3/8" I.D. Black	1BX	10BX
R587435	F5OD	For 5/8" O.D. 1/2" I.D. Black	1BX	10BX
R587440	F6OD	For 3/4" O.D. 5/8" I.D. Black	1BX	10BX

REDDI-STRIP® STAPLER

R587450	RSST	Stapler	1	2
---------	------	---------	---	---

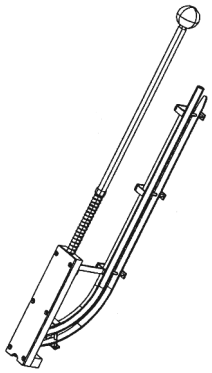

R587450

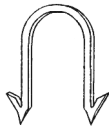

R587460

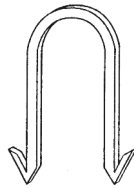

R587465

REDI-STRIP® STAPLES (200 Per Box)

R587460	S5RE-13	I.D. 5/8" Red Up to 3/4" surface penetration in insulation tarp.	1BX	10BX
R587465	S5RE-16	I.D. 5/8" Red Up to 1 1/4" surface penetration in 1 1/2" foamboard.	1BX	10BX

WATER HEATER PANS

CAT. NO.	PVC PART NO.	BOTTOM I.D.	TOP MAX. I.D.	BOX QTY.	VOL. QTY.
----------	--------------	-------------	---------------	----------	-----------

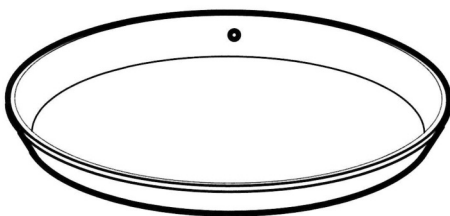

ALUMINUM WATER HEATER PANS

Protects floors and ceilings from water damage
Pre-drilled for 1" PVC drain (included)
Complies with SBCCI Code Section 1213.7
Round shaped aluminum pan

R590000	AWHP-20-5	20"	22"	10	20
R590005	AWHP-22-5	22"	24"	10	20
R590010	AWHP-24-5	24"	26"	10	20
R590015	AWHP-26-5	26"	28"	10	20
R590020	AWHP-30-5	30"	32"	5	10

WATER HEATER PANS

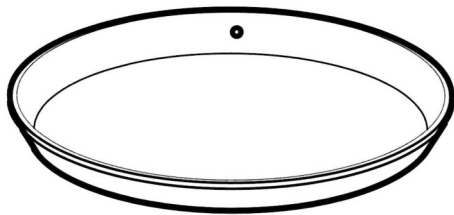

PLASTIC WATER HEATER PANS

Protects floors and ceilings from water damage
 Pre-drilled for 1" drain (included)
 Round shaped black plastic pan
 Complies with SBCCI Code Section 1213.7

CAT. NO.	MFG. NO.	BOTTOM I.D.	TOP MAX. I.D.	DRAIN MATERIAL	BOX QTY.	VOL. QTY.
R590025	WHP-24-5	24"	26"	PVC	20	40
R590030	WHP-26-5	26"	28"	PVC	10	20
R590035	WHP-30-5	30"	32"	PVC	5	10
R590040	WHPC-20-5	20"	22"	CPVC	10	20
R590045	WHPC-22-5	22"	24"	CPVC	10	20
R590050	WHPC-24-5	24"	26"	CPVC	10	20
R590055	WHPC-26-5	26"	28"	CPVC	10	20
R590060	WHPC-30-5	30"	32"	CPVC	5	10

WASHING MACHINE PAN

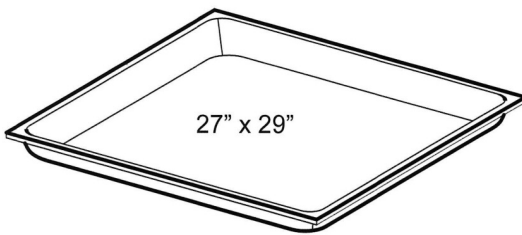

RECTANGULAR PLASTIC WASHING MACHINE PAN

Protects floors and ceilings from water damage
 Rectangular shaped white plastic pan
 1" drain fitting (included)
 Pan NOT drilled

CAT. NO.	MFG. NO.	BOTTOM DIM.	TOP MAX. DIM.	BOX QTY.	VOL. QTY.
R590070	WMP-1-5	27" x 29"	28 1/2" x 30 1/2"	5	15

SCRUBBING TOWELS



BLUE MONSTER® CITRUS SCRUBBING TOWELS

CAT. NO.	MFG. NO.	DESCRIPTION	BOX QTY.	VOL. QTY.
R590100	77095	Floor Display - 75 count 10" x 12"	20	80

RICHARD SPECIALTY CO., INC.

RUBBER JOINT RUNNERS

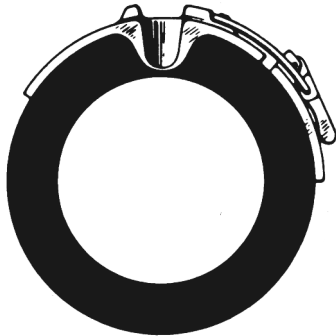

See Page 84



Petersen Sewer Flushers

SEWER FLUSHERS TO FIT EVERY PLUMBERS NEEDS

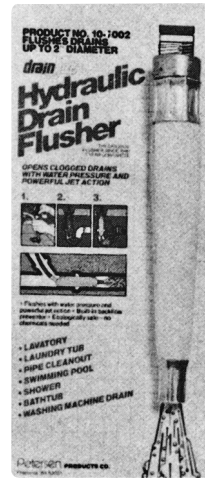

See Page 45

INTERNAL PIPE WRENCHES

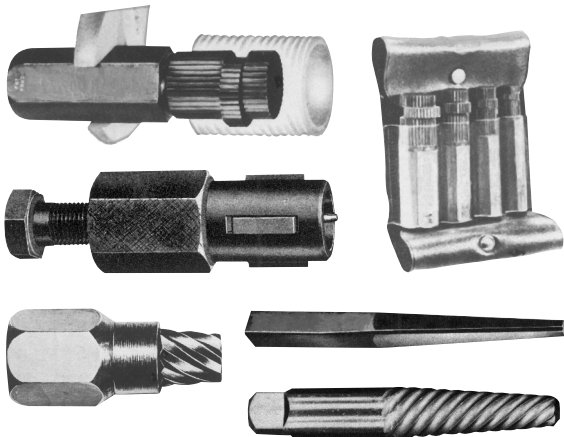

See Page 17-19



BLUE MONSTER®

TEFLON™ TAPE AND COMPRESSION SEAL TAPE

See Page 146

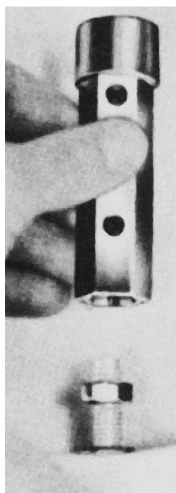

VAN HOUTTE

14 IN ONE CLOSET SEAT WRENCH

FITS ALL THESE NUTS

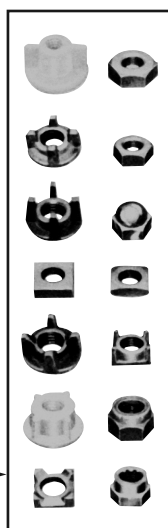

See Page 14

Twis-Tite®

ADJUSTABLE FLOOR DRAIN STOPPER & TEST PLUG



See Page 26

SEWER STOPS

Prevent basement flooding
from over-loaded sewers!



See Page 121

RATCH-CUT METAL TUBING CUTTERS

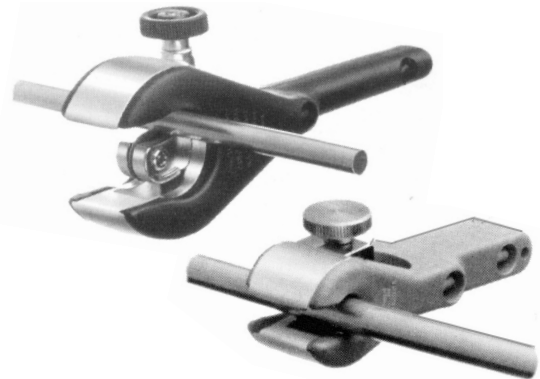

See Page 86

CALKING TOOLS

Quality Plumbing Tools

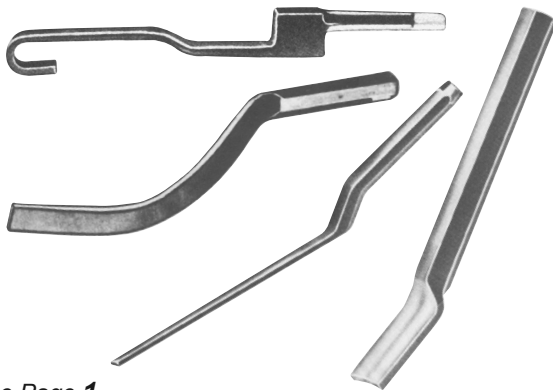

See Page 1

TOOLS BY CHANNEL LOCK®

Quality Tools for the
Plumbing/Heating and
Air Conditioning Industry



See Page 6-11

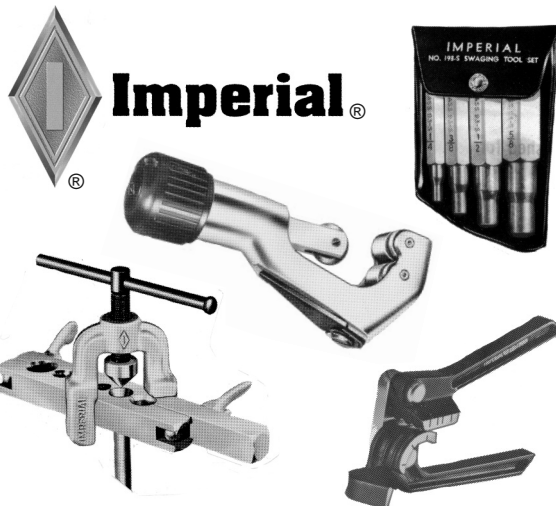

See Page 86-92

SPLIT-ONE™

FLOOR &
CEILING
PLATES

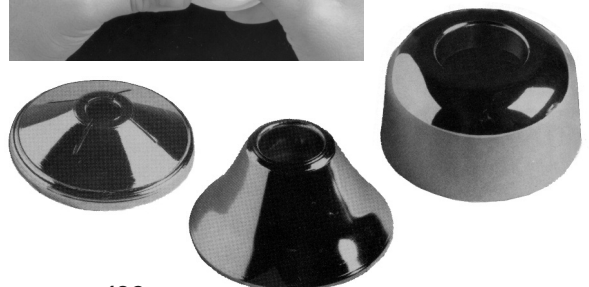
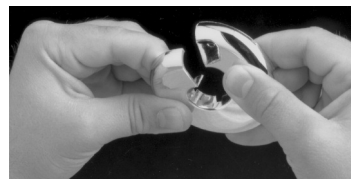

See Page 128

RICHARD SPECIALTY CO., INC.

CLIP GUN SYSTEMS

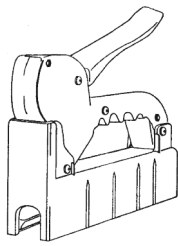
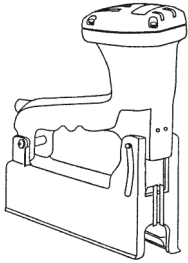

Pneumatic Clip Gun

Manual Clip Gun

Clips-
Stand
Off

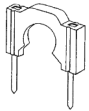

Clips-
Flush
Mount

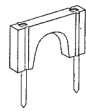

See Page 194

HOT TAPPER

**1/2 INCH
THROUGH
6 INCH
HOT TAPPERS**

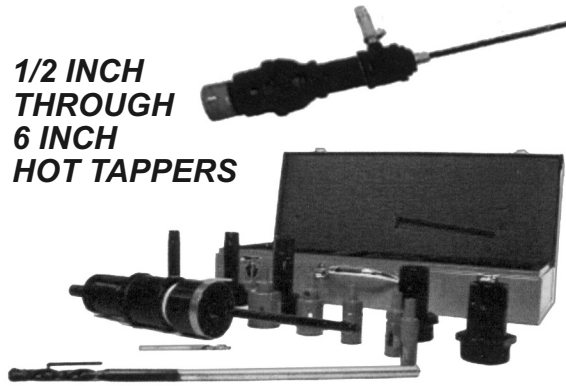

See Page 192

RINSE QUIK

Complete Hose & Spray Head

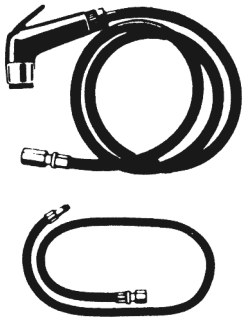

Standard Heads
with 4 Ft. Hose
& Universal
Coupling.

Rinse Quik colors
come in Black,
White, Bone, and
Natural Hose with
Chrome Head.

See Page 113

"SOCKET SAVERS"

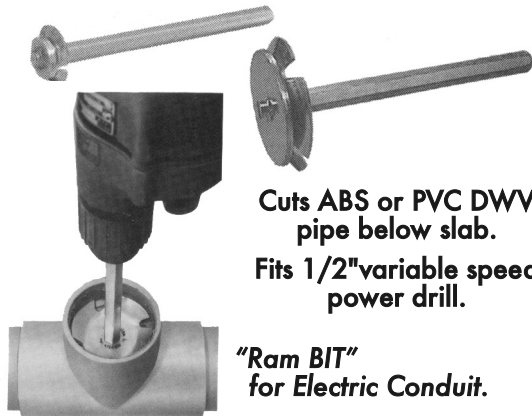

Cuts ABS or PVC DWV
pipe below slab.

Fits 1/2" variable speed
power drill.

"Ram BIT"
for Electric Conduit.

See Page 175

LAST DROP SUCTION GUN



See Page 139

BASSET BRACKETS

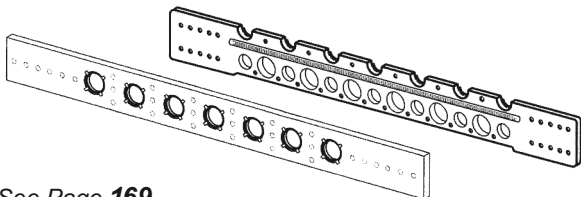

See Page 169

CRETE-SLEEVE™ Plastic Hole Forms

*Two
or more
telescope
together
for deeper
slabs.*

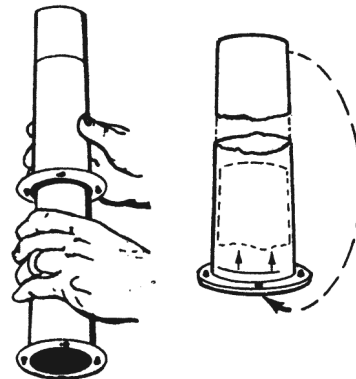

See Page 107

Kollar Kap

(The original styrofoam closet flange spacer.)



**ELIMINATES
ACCURATE
ROUGH-IN**



ONE PIECE
STYROFOAM
INSTALL
IN SECONDS
ELIMINATES
CHIPPING

See Page 107

"Get Sweet"™

by Bronella Co.

Makes Repairs Quickly



**SOLDER WITH
WATER
IN LINES**

Quick work on
ALL FULL-PORT
gate valves,
ball valves
and fittings.

See Page 163

ARCTIC FREEZE™

PORTABLE CO₂ PIPE FREEZING KIT



See Page 187

IceBreaker

PIPE THAWING EQUIPMENT



See Page 165

PEX

CLAMPS AND TOOLS

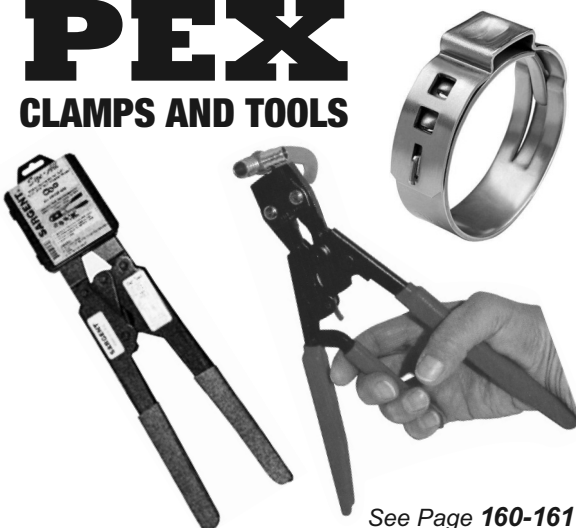

See Page 160-161

GAUGES



See Page 57-64

